



**Hot Cathode Ionization Vacuum Gauge
IGM401 Module
*The Hornet™***



User Manual

InstruTech
1475 S. Fordham St.
Longmont, CO 80503
USA

Phone: +1-303-651-0551
Fax: +1-303-678-1754
E-mail info@instrutechinc.com
www.instrutechinc.com

NOTICE

This User Manual is applicable to the InstruTech® Hornet™ model IGM401 product manufactured with firmware p/n 2444 versions 100 or higher. For previous versions of IGM401 manufactured prior to the introduction of firmware p/n 2444-100, please go to <http://www.instrutechinc.com/downloads-archived-user-manuals/> to find the version of user manual applicable to prior versions of IGM401. See [section 5.8.6, SERVICE MENU](#) of this manual to determine the firmware version of your IGM401.

Important User Information

There are operational characteristic differences between solid state equipment and electromechanical equipment. Because of these differences, and because there are a variety of uses for solid state equipment, all persons that apply this equipment must take every precaution and satisfy themselves that the intended application of this equipment is safe and used in an acceptable manner.

In no event will InstruTech be responsible or liable for indirect or consequential damages that result from the use or application of this equipment.

Any examples or diagrams included in this manual are provided solely for illustrative purposes. Because of the many variables and requirements imposed on any particular installation, InstruTech cannot assume responsibility or liability for any actual use based on the examples and diagrams.

No patent liability is assumed by InstruTech with respect to use of information circuits, equipment, or software described in this manual.

Throughout this manual we use notes, notices and apply internationally recognized symbols and safety messages to make you aware of safety considerations.

**WARNING**

Identifies information about practices or circumstances that can cause electrical or physical hazards which, if precautions are not taken, could result in death or serious injury, property damage, or economic loss.

**CAUTION**

Identifies information about practices or circumstances that can cause electrical or physical hazards which, if precautions are not taken, could result in minor or moderate injury, property damage, or economic loss.

NOTICE

Identifies information that is critical for successful application and understanding of the product.

**SHOCK HAZARD**

Labels may be located on or inside the device to alert people that dangerous voltages may be present.

Copyright © 2011 by InstruTech

All rights reserved. No part of this work may be reproduced or transmitted in any form or by any means, electronic or mechanical, including photocopying and recording, or by any information storage or retrieval system, except as may be expressly permitted in writing by InstruTech.

Printed in the United States of America

Granville-Phillips® and Micro-Ion® are registered trademarks of MKS Instruments, Andover, MA
Conflat® is a registered trademark of Varian, Inc. / Agilent Technologies, Lexington, MA
Teflon® is a registered trademark of E.I. du Pont de Nemours and Company, Wilmington, DE
Swagelok®, Cajon®, VCR® are registered trademarks of the Swagelok Company, Solon, OH.
Hyperterminal® is a registered trademark of Hilgraeve, Inc., Monroe, MI

Table of Contents

1	Introduction / General Information.....	4
1.1	Description	4
1.2	Specifications	4
1.3	Dimensions.....	5
1.4	Part Numbers	5
1.5	Options & Accessories.....	5
2	Important Safety Information.....	6
2.1	Safety Precautions - General.....	6
2.2	Safety Precautions - Service and operation	7
2.3	Electrical Conditions.....	8
2.3.1	Proper Equipment Grounding.....	8
2.3.2	Electrical Interface and Control.....	8
2.4	Overpressure and use with hazardous gases.....	9
2.5	Gases other than Nitrogen / air	9
3	Installation	10
3.1	Mechanical Installation	10
3.2	Electrical Installation	11
3.2.1	Grounding.....	11
3.2.2	Connectors	11
3.2.2.1	Analog Connector pin-out.....	12
3.2.2.2	RS485 COM / Relay Connector pin-out.....	13
4	Bakeout.....	14
5	Setup and Operation.....	15
5.1	Applying power	15
5.2	Emission Current	15
5.3	Overpressure shut down.....	16
5.4	Degas.....	16
5.5	Filament Material Selection / Venting the Chamber	17
5.6	User Interface Basics	18

5.7 Factory-Set Default Parameters19

5.8 Programming.....20

 5.8.1 SETUP DISP21

 5.8.2 SETUP UNIT22

 5.8.3 SETUP IG25

 5.8.4 ANALOG OUTPUT27

 5.8.5 SETUP COMMS28

 5.8.6 SERVICE MENU28

5.9 Activating the sensor.....29

6 Using the gauge with different gases30

7 Analog Output.....31

8 RS485 serial communications32

 8.1 Device Specific Serial Communication Info32

 8.2 RS485 Command Protocol Summary33

9 Service.....37

 9.1 Calibration37

 9.2 Troubleshooting - Operation.....37

 9.3 Troubleshooting - Error Messages38

 9.4 Troubleshooting - Filaments F1 or F2 open39

 9.5 R & D (Research) Diagnostic Display40

 9.6 Maintenance42

 9.7 Contamination.....43

 9.8 Sensor Replacement.....44

10 Factory Service and Support45

11 Warranty45

1 Introduction / General Information

1.1 Description

A hot cathode ionization gauge (IG) measures vacuum pressure by ionizing gas atoms and molecules inside the vacuum region of the gauge transducer and measuring the quantity of ions produced. The measurement of the resulting ion current is directly proportional to the density of gas inside the gauge transducer therefore proportional to the pressure. As pressure inside the vacuum system drops, there are fewer ions created and therefore ion current measured is lower translating to a lower pressure reading.

The InstruTech® IGM401 *Hornet*™ module provides the basic signal conditioning required to turn a hot cathode ionization vacuum gauge into a complete measuring instrument. The module provides a log-linear analog output, RS485 serial communications, and one setpoint relay. In addition, a built-in display provides a convenient user interface for setup and operation of the vacuum gauge. The measurement range for the IGM401 hot cathode ionization gauge is 1×10^{-9} to 5×10^{-2} Torr.

1.2 Specifications

measurement range	1×10^{-9} to 5×10^{-2} Torr / 1.3×10^{-9} to 6.7×10^{-2} mbar / 1.3×10^{-7} to 6.7 Pa
accuracy - N ₂ (typical)	1×10^{-8} to 5×10^{-2} Torr; $\pm 15\%$ of reading
repeatability - (typical)	$\pm 5\%$ of reading
display	OLED graphical display, 3 digits plus 2 digits exponent, user-selectable Torr, mbar, or Pa
materials exposed to gases	dual filaments: yttria coated iridium or optional tungsten Ion collector: tungsten Grid: 304 Stainless Steel Others: 316/304 SS, glass, nickel
sensitivity	factory pre-set. Also user adjustable between 2 to 99 using the display
x-ray limit	$< 5 \times 10^{-10}$ Torr, $< 6.7 \times 10^{-10}$ mbar, $< 6.7 \times 10^{-8}$ Pa
emission current	100 μ A, 4 mA, or automatic switching between 100 μ A and 4 mA
degas	3 W, electron bombardment
overpressure protection	gauge turns off at factory default setting of 5×10^{-2} Torr
internal gauge volume	1.0 in ³ (16.4 cm ³)
temperature	operating; 0 to + 40 °C storage; -40 to + 70 °C
bakeout temperature	200 °C (sensor only - electronics removed)
humidity	0 to 95% Relative Humidity, non-condensing
weight	0.6 lb. (0.27 kg) with NW25 KF flange
housing (electronics)	aluminum extrusion
mounting orientation	any
altitude	operating; 8,200 ft. (2,500 m) max storage; 41,000 ft. (12,500 m) max
serial communications	RS485 - ASCII protocol; minimum command interval: 50 ms
analog output	log-linear 0 to 9 Vdc, 1 V/decade
setpoint relay	one single-pole, double-throw (SPDT), 1A at 30 Vdc resistive, or ac non-inductive
status outputs	degas & filament on/off status are determined by display messages, via open collector transistor or RS485 communication
input signal	degas and filament on/off & emission current are set by continuity to ground using digital inputs, RS485 or manually using front panel push buttons
filament selection	filament 1 or 2 selectable via front panel push buttons or RS485 commands
input power	20 to 28 Vdc, 30 W protected against power reversal and transient over-voltages
connectors	9-pin D-sub male for analog and 9-pin D-sub female for RS485
CE compliance	EMC Directive 2014/30/EU, EN55011, EN61000-6-2, EN61000-6-4, EN61326-1, EN61010-1
environmental	RoHS

1.3 Dimensions

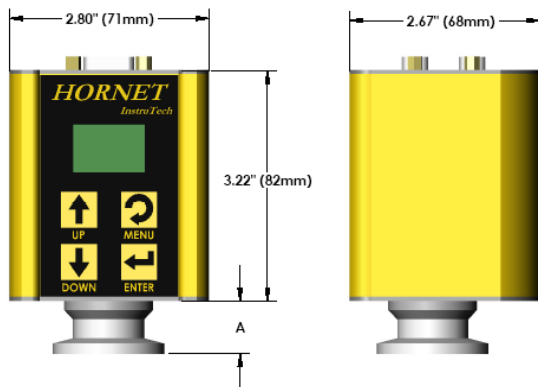

fitting	dimension A
NW16KF	1.45 in. (37mm)
NW25KF	1.45 in. (37mm)
NW40KF	1.45 in. (37mm)
1 1/3 in. Mini CF	1.85 in. (47 mm)
2 3/4 in. Conflat®	1.70 in. (43 mm)
3/4 in. Tube	2.16 in. (55 mm)
1/2 in. VCR	2.58 in. (65 mm)

1.4 Part Numbers

<u>IGM401 Fittings / Flanges</u>	<u>With Yttria Filaments</u>	<u>With Tungsten Filaments</u>	<u>Replacement Sensor - Yttria</u>	<u>Replacement Sensor - Tungsten</u>
NW16KF	IGM401YBD	IGM401TBD	IG4YB	IG4TB
NW25KF	IGM401YCD	IGM401TCD	IG4YC	IG4TC
NW40KF	IGM401YDD	IGM401TDD	IG4YD	IG4TD
1 1/3 in. Mini-CF/NW16CF Mini-Conflat®	IGM401YED	IGM401TED	IG4YE	IG4TE
2 3/4 in. CF / NW35CF Conflat®	IGM401YFD	IGM401TFD	IG4YF	IG4TF
3/4 in. Tube (3/4 in. O.D. O-ring compression)	IGM401YAD	IGM401TAD	IG4YA	IG4TA
1/2 in. Cajon® 8VCR® female	IGM401YHD	IGM401THD	IG4YH	IG4TH

1.5 Options & Accessories

PS501-A

Compatibility: Powers the IGM401 *Hornet™* vacuum gauge module

Power Input: 100 - 240 Vac
 Power Plug: North American 115 Vac
 Output: 24 Vdc @ 2.5 A (60 W)



Connector: 9-pin D-sub female to mate with and power the IGM401 module

Cable length: 6 ft. (2 m)

Note: 9-pin D-sub connector backshell can be opened to enable connections to signals and relays

2 Important Safety Information

InstruTech has designed and tested this product to provide safe and reliable service, provided it is installed and operated within the *strict safety guidelines provided in this manual*. **Please read and follow all warnings and instructions.**



To avoid serious injury or death, follow the safety information in this document. Failure to comply with these safety procedures could result in serious bodily harm, including death, and or property damage.

Failure to comply with these warnings violates the safety standards of installation and intended use of this instrument. InstruTech disclaims all liability for the customer's failure to comply with these instructions.

Although every attempt has been made to consider most possible installations, InstruTech cannot anticipate every contingency that arises from various installations, operation, or maintenance of the module. If you have any questions about the safe installation and use of this product, please contact InstruTech.

This device meets FCC part 15 requirements for an unintentional radiator, class A.

2.1 Safety Precautions - General

Hazardous voltages are present with this product during normal operation. The product should never be operated with the covers removed unless equivalent protection of the operator from accidental contact with hazardous internal voltages is provided.

 **WARNING!** There are no operator serviceable parts or adjustments inside the product enclosure; refer servicing to service trained personnel.

Do not modify this product or substitute any parts without authorization of qualified InstruTech service trained personnel. Return the product to an InstruTech qualified service and repair center to ensure that all safety features are maintained. Do not use this product if unauthorized modifications have been made.

 **WARNING!** Source power must be removed from the product prior to performing any servicing.

After servicing this product, ensure that all safety checks are made by a qualified service person. When replacement parts are required, ensure that the parts are specified by InstruTech. Substitutions of non-qualified parts may result in fire, electric shock or other hazards. Use of unauthorized parts or modifications made to this product will void the warranty.

To reduce the risk of fire or electric shock, do not expose this product to rain or moisture. These products are not waterproof and careful attention must be paid to not spill any type of liquid onto these products. Do not use these products if they have been damaged. Immediately contact InstruTech to arrange return of the product if it is damaged.

Due to the possibility of corrosion when used in certain environmental conditions, it is possible that the product's safety could be compromised over time. It is important that the product be periodically inspected for sound electrical connections and equipment grounding. Do not use if the equipment grounding or electrical insulation has been compromised.

2.2 Safety Precautions - Service and operation

Ensure the IGM401 is properly connected to earth ground.

Do not turn on filaments and try to activate the sensor when pressure exceeds 1.00×10^{-3} Torr if the device is operating at the 4 mA emission current setting.

Do not turn on the filaments and try to activate the sensor when pressure exceeds 5.00×10^{-2} Torr if the device is operating at the 100 μ A emission current setting.

Ensure vacuum level is at or less than 5.00×10^{-5} Torr before attempting to initiate degas.

⚠ WARNING! The power supply used in the IGM401 hot cathode gauge module is subject to high voltages which could cause severe injury or death. In order to prevent electric shock and bodily harm, the user should wait 5 minutes after power is removed before touching the IGM401 power supply components.

⚠ WARNING! When the IGM401 is turned on, 180 V is present at the power supply and other components such as the ion gauge and the cable. Furthermore, voltages as high as 350 V are present during degas. **DO NOT** operate the IGM401 with the IGM401 enclosure removed. Contact with exposed electrical circuits in the IGM401 could result in death or serious injury.

NOTICE

Do not use another gauge to automatically turn off the ion gauge when the ion gauge filament in use is constructed of tungsten (yttria coated filament is ok). The response time of other gauges may not allow for timely turn off of the tungsten filament leading to filament damage. Always turn off the IG filament manually before pressure is to rise above 1.00×10^{-3} Torr.

When using yttria coated filaments, it is highly recommended to periodically alternate operating Filaments 1 and 2. An inactive filament not operating for an extended length of time may result in that filament failing to establish emission current when it is eventually used. This will be more problematic in dirty applications.

Use an appropriate power source of 20 to 28 Vdc, 30 W min. (InstruTech PS501 power supply is rated 60 W).

Turn off power to the unit before attempting to service the module. Turn off power to the unit before detaching the electronics from the sensor for sensor replacement or bake-out purposes.

Turn off power to the unit if a cable or plug is damaged or the product is not operating normally according to this instruction manual.

Do not use if the unit has been dropped or the enclosure has been damaged. Contact InstruTech for return authorization and instructions for returning the product to InstruTech for evaluation.

Use yttria coated filaments with air and inert gases such as N₂, argon, etc. Optional tungsten filaments are available for use with gases not compatible with yttria filaments.

The most common cause of all vacuum gauge failures is contamination of the sensor. Noisy or erratic readings and total gauge failure are possible indications of gauge contamination. Contamination can generally be characterized as either:

- A) A physical or chemical reaction of process gases with the sensor element. A different gauge may be considered if neither yttria coated nor tungsten filament sensor materials are compatible with your application.
- B) An accumulation of material on the sensor element. In this case, performing the degas function of the instrument may resolve the issue.

2.3 Electrical Conditions

 **WARNING!** When high voltage is present in any vacuum system, a life threatening electrical shock hazard may exist unless all exposed electrical conductors are maintained at earth ground potential. This applies to all products that come in contact with the gas contained in vacuum chambers. An electrical discharge within a gaseous environment may couple dangerous high voltage directly to any ungrounded conductor of electricity. A person could be seriously injured or killed by coming in contact with an exposed, ungrounded electrical conductor at high voltage potential. This condition applies to all products that may come in contact with the gas inside the vacuum chamber (vacuum/pressure containment vessel).

2.3.1 Proper Equipment Grounding

 **WARNING!** Hazardous voltages that could seriously injure or cause death are present in many vacuum processes. Verify that the vacuum connection port on which the ion gauge is mounted is electrically grounded. Consult a qualified Electrician if you are in doubt about your equipment grounding. Proper grounding of your equipment is essential for safety as well as intended operation of the equipment. The vacuum gauge transducer and enclosure of any control module must be connected directly to a good quality equipment earthing conductor. Use a ground lug on the vacuum connection flange of the pressure measurement device if necessary.

 **WARNING!** In order to protect personnel from electric shock and bodily harm, shield all conductors which are subject to potential high voltage electrical discharges in or around the vacuum system.

2.3.2 Electrical Interface and Control

It is the user's responsibility to ensure that the electrical signals from this product and any connections made to external devices, for example, relays and solenoids, are used in a safe manner. Always double check the system set-up before using any signals to automate your process. Perform a hazardous operation analysis of your

system design and ensure safeguards and personnel safety measures are taken to prevent injury and property damage.

2.4 Overpressure and use with hazardous gases

⚠ WARNING! Install suitable protective devices that will limit the level of pressure inside your vacuum chamber to less than what the vacuum chamber system components are capable of withstanding.

In cases where an equipment failure could cause a hazardous condition, always implement fail-safe system operation. For example, use a pressure relief device in an automatic backfill operation where a malfunction could result in high internal pressures if the pressure relief device was not installed on the chamber.

The IGM401 is not intended for use at pressures above 20 psia (1000 Torr); DO NOT exceed 35 psig (< 2 ½ bars) pressure inside the sensor. If your chamber goes to higher pressures, you should install an isolation valve or pressure relief device to protect the gauge tube from overpressure conditions. With some fittings, actual safe overpressure conditions may be lower; for example, a quick-connect, O-ring compression fitting may forcibly release the gauge tube from the vacuum chamber fitting with only a few psi over local uncorrected barometric (atmospheric) pressure.

⚠ CAUTION! If the internal pressure of a vacuum gauge device is allowed to increase above local uncorrected barometric pressure (atmospheric pressure side), vacuum fittings may release and possible overpressure conditions may cause leaks that would allow the gas inside the gauge tube to release into the atmosphere of the surrounding environment. Toxic, pyrophoric and flammable gases are examples of hazardous gases that if allowed to leak out of the vacuum/pressure containment vessel into the atmospheric environment, could cause bodily injury and possible damage to equipment. Never expose the gauge tube internal volume to pressure above local atmospheric pressure when using hazardous gases.

2.5 Gases other than Nitrogen / air

⚠ WARNING! Do not attempt to use with gases other than nitrogen (N₂) or air without referring to correction factor data tables.

InstruTech gauges and modules are calibrated for direct readout of nitrogen or air. Do not attempt to use with other gases such as argon (Ar) or carbon dioxide (CO₂), unless you have programmed the device for the appropriate gas or use accurate conversion data for N₂ to other gases. Refer to [section 6](#) titled “Using the gauge with different gases” for a more complete discussion.

⚠ WARNING! Do not use this device in an explosive atmosphere or in the presence of flammable gases, vapors or fumes. Do not use this device to measure the pressure of explosive or combustible gases or gas mixtures. The sensor filaments operate at incandescent temperatures and could become an ignition source. This could cause an explosion which could result in serious injury or death.

3 Installation

3.1 Mechanical Installation

Mount the IGM401 as close as possible to the pressure you want to measure. Long or restricted, small diameter tubing will create a pressure difference between your process chamber and the gauge. This may cause a delay in response to pressure changes. Mounting the IGM401 too close to a gas source inlet may also cause measurement and control instability.

The IGM401 can be mounted in any orientation, however, if possible, mount the gauge with port down to help minimize the effect of any particles or condensation collecting in the gauge.

Do not mount the IGM401 where it will be subjected to excessive vibration. Vibrations may cause unstable readings, measurement errors and possible mechanical stress to components in the IGM401.

Shield the IGM401 near ion or electron sources such as an electron beam or in a sputtering system.

For electrical safety purposes the housing of the gauge must be grounded to the vacuum chamber. When using KF flanges, metal clamps must be used to ensure proper grounding. Do not attempt to modify your flange in order to use non-metallic-type flange clamps.

Fittings/Flanges - follow the fitting/flange manufacturer's recommendations for installation and use.

Use all metal vacuum fittings with metal seals when operating pressures are expected to be below 1.00×10^{-7} Torr (1.33×10^{-7} mbar, 1.33×10^{-5} Pa).

3.2 Electrical Installation

3.2.1 Grounding

⚠ Be sure the vacuum gauge and the rest of your vacuum system are properly grounded to protect personnel from shock and injury. Be aware that some vacuum fittings, especially those with O-rings when not used with metal clamps, may not produce a good electrical connection between the gauge and the chamber it is connected to. Use a ground lug on the vacuum connection flange of the pressure measurement device if necessary.

3.2.2 Connectors

The IGM401 allows for operation of the unit including turning the gauge/filaments on/off, selecting emission current and turning degas on/off using digital inputs, RS485 communication commands or the front panel push buttons.

Good, recommended practice is to remove power from any cable prior to connecting or disconnecting it.

The IGM401 is provided with two D-sub connectors used for I/O interface as shown below:

1. 9-pin, D-sub male (DE-9P) connector for Digital I/O and analog output.
2. 9-pin, D-sub female (DE-9S) connector for relay connections and RS485 serial communications.

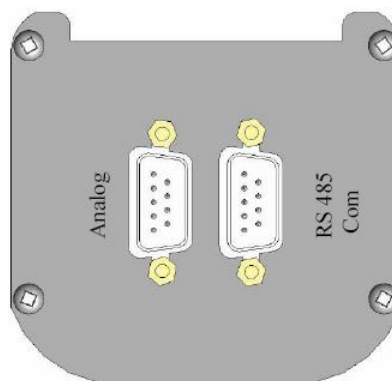

IGM401 I/O Interface

When using InstruTech's power Supply PS501A, connect the power supply to the ANALOG connector. If using a power supply other than InstruTech's PS501A, connect your power supply to either the RS485 or the ANALOG connector as shown on the next page.

⚠ CAUTION! Do not connect power to both the Analog and the RS485 connectors.

Fabricate a cable according to your interface requirements. For analog signals and digital inputs use the 9-pin, D-Sub male (DE-9P) connector. For relay connections and serial communications use the 9-pin, D-Sub female (DE-9S) connector. Refer to the following pages for detailed explanations of the connector pin-outs.

3.2.2.1 Analog Connector pin-out

⚠ CAUTION! Do not connect power to both the Analog and the RS485 connectors. Apply power only to one or the other. Applying power to both connectors may cause damage to the gauge and other connected devices.

When using digital inputs to operate the gauge, use the 9-pin D-sub male ANALOG connector described below:

ANALOG I/O 9-Pin D-sub (DE-9P) male connector

PIN NUMBER	PIN DESCRIPTION
1	Sensor on/off input signal. The ion gauge (IG) filament is activated by applying a continuous ground (relative to pin 2, Power Ground). This will activate the sensor and will turn on the filament. The IG filament is turned off by removing the ground. See section 5.9 for other methods of activating the sensor.
2	Power ground & sensor on/off ground.
3	Analog output (log-linear 0 to 9 Vdc, 1 V/decade).
4	Power input (20-28 Vdc at 30 W, minimum). Do not connect power to both the Analog and the RS485 connectors. Apply power only to one or the other.
5	Degas status output signal. This is an output signal to other external instruments to confirm degas is on or off. Signal: Open collector transistor (ground emitter) rated at 40 V max. V_{CE} , 50 mA I_C max. Transistor off = degas off, transistor on = degas on.
6	Degas on/off input signal. Degas is initiated by applying a momentary ground. The degas cycle will last for 2-10 minutes (based on user setting) even if ground is removed. The ground must be removed to start cycle again.
7	Analog output signal ground (Do not use for sensor on/off ground).
8	Emission current. Applying ground changes emission current from 100 μ A to 4 mA.
9	Sensor status. This is an output signal to other external instruments to confirm IG filament is on or off. Signal: Open collector transistor (ground emitter) rated at 40 V max. V_{CE} , 50 mA I_C max. Transistor off = IG filament off, transistor on = IG filament on.

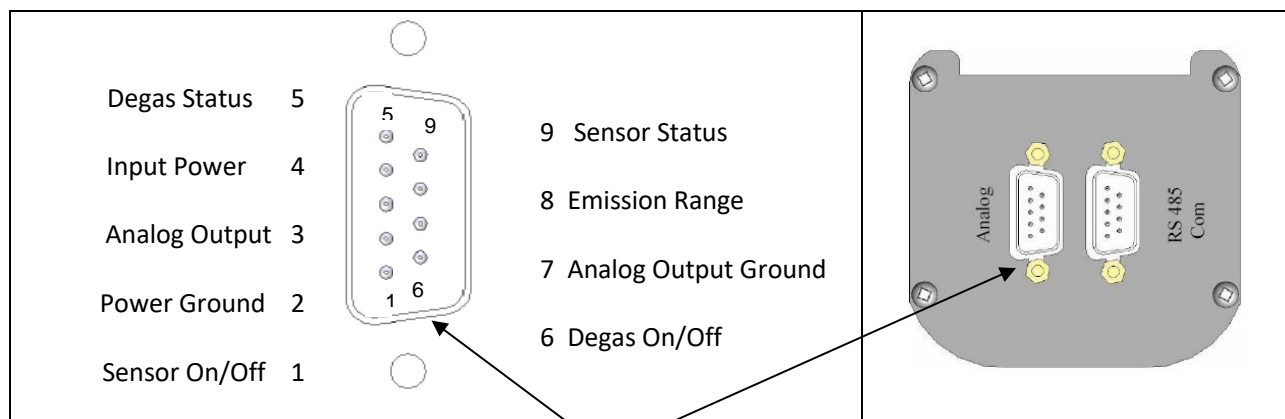

ANALOG I/O 9-Pin D-sub male (DE-9P) connector

Note - If you are replacing the **analog output** version of the Granville-Phillips® 354 Micro-Ion® module, simply plug your existing cable into the IGM401 module 9-pin D-sub connector marked “Analog”. See the following page if you are using the RS485 (with setpoint Relay) version of the Granville-Phillips® 354 Micro-Ion® module.

3.2.2.2 RS485 COM / Relay Connector pin-out

⚠ CAUTION! Do not connect power to both the Analog and the RS485 connectors. Apply power only to one or the other. Applying power to both connectors may cause damage to the gauge and other connected devices.

When using the RS485 serial communications mode of operation, use the 9-pin D-sub female (DE-9S) RS485 COM connector as described below. The same connector is also used for ion gauge setpoint relay connections.

RS485 COM / Relay 9-Pin D-sub (DE-9S) female Connector

PIN NUMBER	PIN DESCRIPTION
1	Setpoint relay - Normally Open; referred to as RLY I on front panel display
2	Power Input (20-28 Vdc at 30 W). Do not connect power to both the Analog and the RS485 connectors. Apply power only to one or the other.
3	No connection
4	Power ground (Also when using RS485 serial communications, connect this pin to ground pin of your RS485 converter)
5	Setpoint relay - Normally Closed (RLY I on front panel display)
6	RS485 DATA A (-) Input/output
7	Setpoint Relay - Common (RLY I on front panel display)
8	Not used (do not connect)
9	RS485 DATA B (+) Input/output

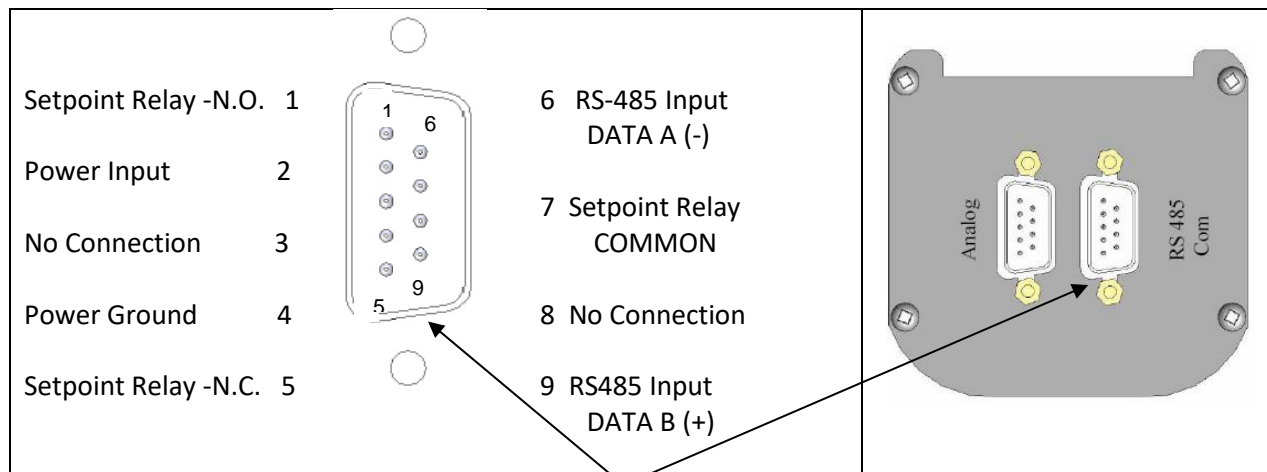

RS485 COM / Relay 9-Pin D-sub female (DE-9S) connector

Note - The RS485 version of MKS Instruments / Granville-Phillips® Series 354 Micro-Ion® is provided with a 9-pin male connector. The InstruTech’s RS485 connector is a 9-pin female connector. If you are replacing an RS485 version of Micro-Ion® and would like to use your existing cable, a 9-pin use a female to male gender changer.

NOTICE

If you are using the InstruTech’s PS501-A power supply and using the RS485 function do not connect power to pins 2 and 4 of the RS485 COM connector. The will be received via the ANALOG connector. Use the RS485 COM connector pins for communications and setpoint relay only. If you intend to operate the IGM401 via RS485 communications only, power may be connected to pins 2 and 4 of the RS485 COM connector but not the analog connector at the same time. Pin-out assignments are not the same, especially for the +24 Vdc power and ground (power return) connections for the Analog and RS-485 COM connectors.

4 Bakeout

If desired, a chamber bake may be performed for new systems or after routine maintenance. The IGM401 sensor can be baked out to 200 °C as long as the sensor fitting uses metal seals. For sensor fittings using elastomer O-rings, the maximum bakeout temperature is limited to the maximum temperature rating of the elastomer O-ring. Ensure the temperature of the sensor tube and the vacuum fitting to the sensor is at the same or above the chamber temperature. The electronic module must be removed from the sensor if the bakeout temperature is to exceed 70 °C. To bake out the sensor use the following procedure:

1. Turn off power to the IGM401.
2. Disconnect the cable from the IGM401.
3. Use a 3/32 in. size Hex key to remove the #4-40 socket head cap screws (SHCS) as shown below.
4. Detach the metal enclosure and the electronics from the sensor. Gently pull the electronics enclosure away from the sensor using a gentle rocking motion.
5. The black plastic cap attached to the sensor and the end plate does not have to be removed for bakeout.
6. Perform bake out with the electronics removed.
7. Reattach the electronics enclosure. Reinstall the screws (4 ea.)

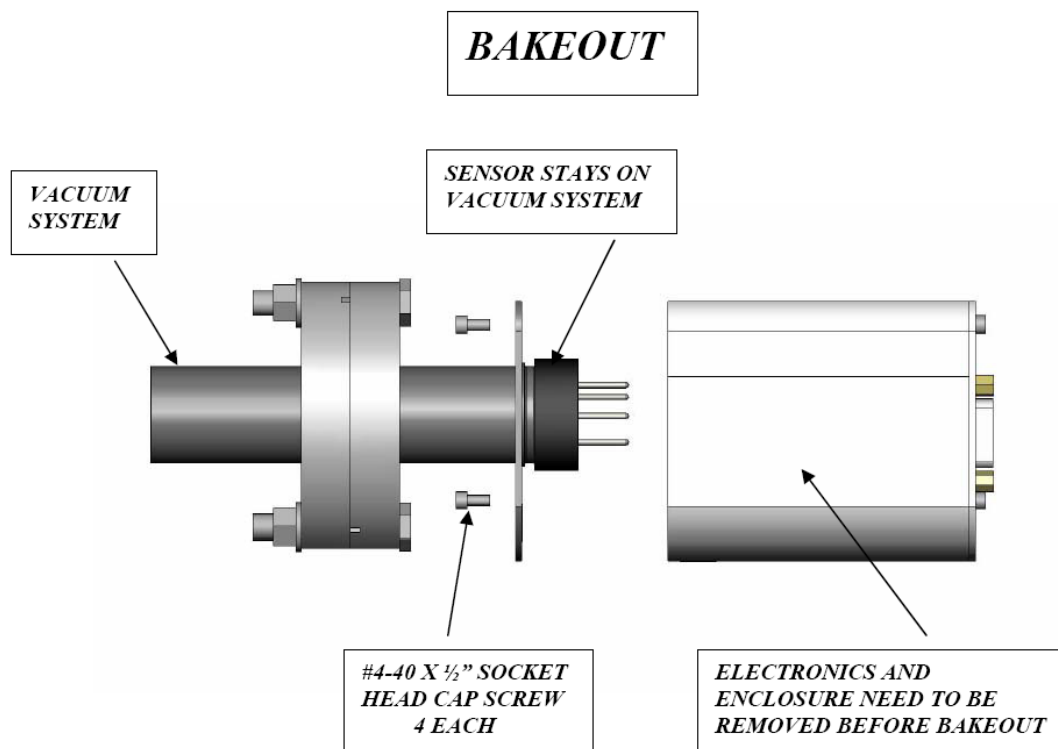

5 Setup and Operation

5.1 Applying power

Connect power to the IGM401 using the designated pins 4 and 2 of either the 9-pin D-sub **ANALOG** or the **RS485 COM** connector. Do not connect power to both connectors simultaneously.

CAUTION! The +24 Vdc Power and Power Ground pin-out connections are not the same on the ANALOG and RS485 COM 9-pin D-subminiature connectors of the IGM401. Equipment damage may result if a mating power/control cable is not wired for the correct power and ground connections. Be certain that you observe the correct pin-out designation for the connector on the IGM401 that you intend to connect to.

Alternatively, you can power the device by connecting InstruTech's PS501-A power supply to the ANALOG connector of the IGM401. When you connect power, the display will show "UNIT STATUS OFF". This indicates the display is on but the filament is not turned on and the sensor has not been activated yet. Read this user manual in its entirety before activating the sensor. Refer to [section 5.9](#) titled "Activating the sensor" for further details.

5.2 Emission Current

Either 4 mA or 100 μ A (0.1 mA) emission current are available settings for electron emission current.

- 1) In clean applications and operating at higher pressure ranges (5.00×10^{-6} Torr to 5.00×10^{-2} Torr) the 100 μ A emission current setting is preferred.
- 2) At lower operating pressures (1.00×10^{-9} Torr to 5.00×10^{-4} Torr) the 4 mA emission current setting should be used.
- 3) The emission current can also be set to automatically switch between 4 mA and 100 μ A. This results in optimal and stable pressure readings over the entire measurement range from low to high vacuum. For example, if an application requires that pressure measurements be performed by the ion gauge from pressures lower than 5.00×10^{-6} Torr to 5.00×10^{-2} Torr, the user may want to consider using the automatic emission current switching feature of this instrument. Switching of the emission current may be programmed to take place at any pressure from 1.00×10^{-6} to 1.00×10^{-4} Torr.
- 4) When using a diffusion pump or other pumps that use fluids, there is a possibility of the pump oil vapors entering the IG transducer. These vapors may form an insulator on the internal components of the transducer which can lead to instability or failure in controlling the emission. In this case, the 4 mA emission current may provide improved operating lifetime and measurement performance.

5.3 Overpressure shut down

The IGM401 is provided with factory set default values for overpressure shut down. The gauge will shut off automatically should the pressure reach or rise above the pressure shut down values shown below:

Factory set overpressure shut down values

Emission Current	Overpressure Shut Down (Torr)	Overpressure Shut Down (mbar)	Overpressure Shut Down (Pa)
4 mA	1.00×10^{-3}	1.33×10^{-3}	1.33×10^{-1}
100 μ A (0.1 mA)	5.00×10^{-2}	6.66×10^{-2}	6.66

The 100 μ A emission current overpressure shut down setting may be adjusted from 1E-05 Torr to 5E-2 Torr.

5.4 Degas

Degas is used to rid the gauge sensor of adsorbed gas. Degas is achieved by applying Electron Bombardment (EB) to the grid. The intervals at which degas should be applied vary for each application. The low pressure measurement performance of the transducer will normally improve after each degassing cycle.

- Degas can only be applied while the filament is turned on and operating.
- Ensure vacuum level is at or less than 5.00×10^{-5} Torr before attempting to initiate degas.
- Power during degas is about 3 watts higher than the normal operating power.
- Degas will automatically turn off after 2 minutes when using factory default settings. Degas can be programmed for duration of 2 to 10 minutes.
- The IGM401 will continue to measure pressure while degas is in progress.
- Degas will automatically turn off if the pressure exceeds 3.00×10^{-4} Torr during the degas cycle.
- Degas can be interrupted by turning the IGM401 filament off.

5.5 Filament Material Selection / Venting the Chamber

The choice of which type of filament to use in the IGM401 is primarily dependent upon the process and process gases the ion gauge will be used with. For general vacuum applications, dual yttria coated filaments are offered for use with air and inert gases such as N₂, argon, etc. Optional dual tungsten filaments are available for use with gases not compatible with yttria filaments.

1) Yttria coated iridium filament

In most general vacuum applications, the yttria coated iridium filament is the best choice.

Yttria coated filaments typically operate at a lower temperature than tungsten filaments and thus have a lower outgassing rate at UHV and lower chemical reactivity with active gases.

Yttria coated filaments typically have a longer operating life than tungsten filaments in clean applications.

The yttria coated filament can survive occasional accidental start attempts at atmosphere in air, but the overall life of the filament may be shortened during each occurrence. Good vacuum practice is to use a separate pressure gauge such as InstruTech's *Stinger™* or *Super Bee™* convection gauge to know when to turn on the ion gauge filament. The relay outputs of convection gauges can be used to turn on the ion gauge filament.

2) Tungsten filament

Typically a bare tungsten filament is a better choice in those applications where an yttria coated filament is quickly damaged due to the gas type in use. For example, processes such as ion implantation may only use tungsten filaments. Be aware that corrosive applications are hard on any filament and filament life will be shortened while operating in such environments. Tungsten filaments are easily damaged by exposure to air/oxygen during accidental system vents or if considerable quantities of water vapor are outgassed during pump-down and bake-out. It is very important to make sure the tungsten filament is turned off before bringing the chamber up to atmosphere, especially if air is being used to vent the chamber. The use of pure N₂ gas is highly recommended to vent or purge your vacuum chamber. Testing has shown that tungsten filaments can withstand limited high pressure excursions when only N₂ is present.

Venting with air or other oxygen containing gases can damage the tungsten filaments. If you try to turn on an ion gauge with tungsten filaments while it is sitting on your desk exposed to room air, you will immediately damage or destroy the filament beyond repair.

NOTICE

Do not use another gauge to automatically turn off the ion gauge when the ion gauge filament in use is constructed of tungsten (yttria coated filament is ok). The response time of other gauges may not allow for timely turn off of the tungsten filament leading to filament damage. Always turn off the IG filament manually before pressure is to rise above 1.00×10^{-3} Torr.

Note - Both types of filaments will suffer eventual damage if operated at high pressures. The type and amount of damage at high pressure is dependent upon the length of operating time, the pressure and the gas present.

5.6 User Interface Basics

The user interface is designed for easy operation and a natural progression of setup parameters. This section gives a brief explanation of operation for added clarity.



Programming soft-keys

There are four soft-keys located on the front panel, below the display. These keys are used to select and program the various functions available. During programming of the IGM401, the display will identify what each function key represents.

To begin programming, press the MENU key. Press the ENTER key to access the parameters and save the new settings. Press the UP and DOWN key to select the desired menu and change the parameters. Press the MENU key to return to the previous menu or press repeatedly to return to the main screen. To continue setting additional parameters, scroll with the UP and DOWN keys until you reach the desired parameter.

5.7 Factory-Set Default Parameters

The following is a summary of all factory-set default¹ values in the IGM401 display menu.

SETUP DISP

- SET CONTRAST [Factory default = 10]
- MODE [Factory default = NORMAL]
- FLIP SCREEN [Factory default = NORMAL]
- SCREEN SAVER [Factory default = ON]

SETUP UNIT

- UNITS [Factory default = TORR]
- DEFAULTS [Factory default = MENU TO EXIT]
- GAS TYPE [Factory default = N2]
- CLR IG ERROR [Factory default = OFF]
- OVER PRESS 100 [Factory default = 5.00E-02 TORR]
- IG CNTL [Factory default = DIGI/RS485, (Factory default is DIGI or Digital Input, see requirement for switching from DIGI to RS485 mode at [DIGI/RS485 section](#), below)] **If IG CNTL is set to FRONT PANEL, the Top Level Program Menu shown here in this section 5.7 will be modified; See [section 5.8.2., -FRONT PANEL](#), for modified Top-Level Program Menu choices when IG CNTL is set for FRONT PANEL.**

SETUP IG

- DEGAS TIME [Factory default = 2]
- SENSITIVITY [Factory default = Actual Sensor sensitivity (nominal = 8-13)]
- FILAMENT NUM [Factory default = FILAMENT 1]
- RLY I LO TRP [Factory default = 1.00E-06 TORR]
- RLY I HI TRP [Factory default = 5.00E-06 TORR]
- RELAY I TEST [Factory default = OFF]
- FIL USAGE [Factory default = Displays to-date filament usage]
- AUTO IE EN [Factory default = DISABLE]
- AUTO IE TRIP [Factory default = DISABLE]

ANALOG OUTPUT

- IG ANALOG CAL [Factory default = Factory Set]

SETUP COMMS

- BAUD RATE [Factory default = 19200, 8, N, 1]
- ADDR [Factory default = 1]
- ADDR OFFSET [Factory default = 0]

SERVICE MENU

- INFO [Factory default = FIRMWARE VERSION]
- OP TIME [Factory default = Displays to-date operating time]

¹ The above correspond to the Granville-Phillips® Series 354 Micro-Ion® module factory settings. If you are replacing a Micro-Ion® module you do not need to change any of the parameters programmed in the factory. If you wish to make any changes refer to the next section for menu item explanations.

5.8 Programming

This section provides detailed information on programming and configuration of various menus and submenus of the device. The main, top-level menu choices shown starting at [section 5.8.1 SETUP DISP](#) (setup display) are what will be displayed when factory defaults are set. If you set **IG CNTL** (ion gauge control) to **FRONT PANEL**, the top-level menu choices change to include easy access for control of **IG ON**, **IG OFF**, **EMISSION SEL**, **DEGAS ON** and **DEGAS OFF**. The main, top-level programming screen is arrived at by pressing the **MENU** key one or more times. If you intend to operate the IGM401 using **FRONT PANEL** control, please see [Top-Level Program Menu when FRONT PANEL is selected for IG CNTL](#) in the **SETUP UNIT** [section 5.8.2](#) below for the ordered list of available choices when in the top-level menu.

Follow the key entry sequences of **MENU** ⇒ **↑** ⇒ or **↓** ⇒ and, finally, **ENTER** ⇒ where the symbol ⇒ represents the act of pressing the appropriate front panel soft-key. Please note that changes to various control functions will not take effect until the selected choice is entered by pressing the **ENTER** key at the desired menu choice and, in some cases, the **MENU** key is pressed to return to the main pressure display screen. In some cases, the **ENTER** key must be pressed multiple times to scroll the cursor (highlighted character) across the displayed menu item until the last character of the displayed line is entered. For example, when changing the value of a setpoint pressure (ON or OFF) for the setpoint relays, note that the highlight cursor will wrap around the menu choices if either one of the **↑** or the **↓** keys are pressed repeatedly.



The menu structure may be visualized as a cascading list of choices navigated to and selected by pressing either the **↑** or the **↓** and **ENTER** keys. An example of navigating to a particular menu choice is given by:

The display is showing the pressure (vacuum) being measured. By pressing the **MENU** key the display will show the top-level menu choices (as shown in the leftmost, bold print menu choices listed in [section 5.7](#), above). If you choose to control the IG using the front panel control mode, then the sequence of key entries is **MENU** ⇒ **↑** ⇒ or **↓** ⇒ until **SETUP UNIT** is highlighted then, **ENTER** ⇒ and, **↑** ⇒ or **↓** ⇒ until **IG CNTL** is highlighted then, **ENTER** ⇒ and, **↑** ⇒ or **↓** ⇒ until **FRONT PANEL** is displayed then, **ENTER** ⇒. The display should now revert back to the main pressure display. Now, if you press the **MENU** key after setting up front panel IG control, you will see the revised top-level menu with the additional choices of **IG ON**, **IG OFF**, **EMISSION SEL**, **DEGAS ON** and **DEGAS OFF** listed as:

- **IG ON**
- **IG OFF**
- **SETUP DISP**
- **SETUP UNIT**
- **SETUP IG**
- **ANALOG OUTPUT**
- **SETUP COMMS**
- **SERVICE MENU**
- **EMISSION SEL**
- **DEGAS OFF**
- **DEGAS ON**

If you have performed the operations as described in the example above to set the IGM401 to **FRONT PANEL** under the **SETUP UNIT** ⇒ **IG CNTL** ⇒ **FRONT PANEL** program menu sequence, refer to the detailed explanation of each of the program choices shown here, at the left, in the following sections. Quick reference to the augmented top-level, main menu is found at [Top-Level Program Menu... in section 5.8.2](#)

5.8.1 SETUP DISP

The following submenu choices allow you to setup the display (DISP) to show the format you desire. These will be shown on the front panel display when you press the ENTER key when SETUP DISP is highlighted. Scroll to the menu of choice by using either the  or  keys.

- **SET CONTRAST** [Factory default = 10]

This function sets the display contrast. Use the ENTER KEY to access the CONTRAST menu and use the UP and DOWN Keys to select a number between 1 and 120. The contrast setting of 120 provides the highest contrast (brightest) and 1 the lowest. Select the ENTER KEY again to save the value selected.

Note - Factory default setting optimizes display life.

- **MODE** [Factory default = NORMAL]

Use the ENTER KEY to access the MODE menu and use the UP and DOWN Keys to select the *NORMAL* or *RESEARCH* display mode. Select the ENTER KEY again to save the desired mode.

NORMAL

This mode displays the most commonly used variables. These are the measured pressure, the pressure unit, the gas symbol, and filament and relay status. All these variables will be displayed on the main screen simultaneously. In the following example, the measured pressure is 6.45E-9 Torr, Filament #1 is on, gas is nitrogen and Relay I is on.

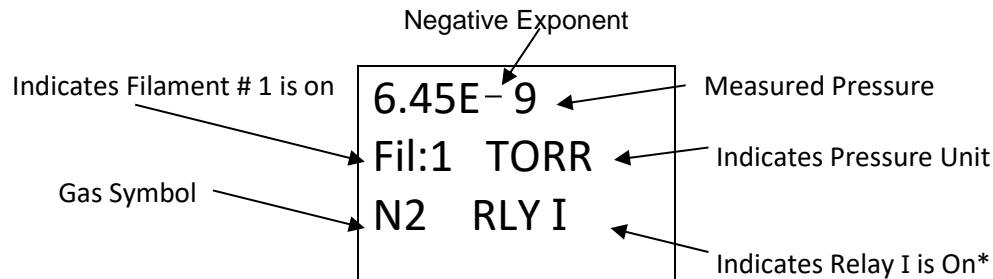

***Note** - The indication "RLY I" disappears from the display when the relay is not energized (turned off).

RESEARCH

This mode displays the measured pressure, emission current, ion current, filament voltage and filament current. In the following example, the measured pressure is 1.00E-9 Torr, (Pressure unit is based on selected units in SETUP UNIT menu). Emission current is 4.00E-3 amperes, Ion current is 4.00E-11 amperes, filament voltage is 1.5 Vdc and filament current is 1.9 amperes.

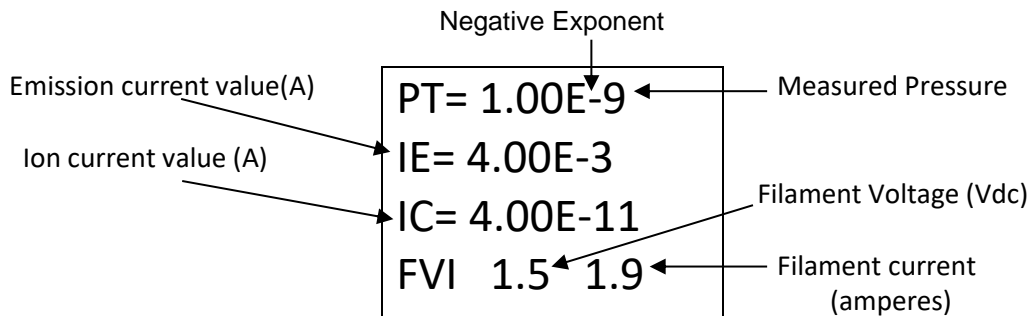
**-FLIP SCREEN** [Factory default = NORMAL]

This allows the user to select a *NORMAL* display or have the pressure measurement data displayed upside down. When the IGM401 is mounted upside down, this selection is used to invert the display screen 180 degrees for user convenience. **Note** - When UPSIDE DOWN is selected, the user has to save the setting and exit the menu before the measured values are displayed.

-SCREEN SAVER [Factory default = ON]

The Hornet uses an OLED type display which over an extended period of time can start to show divergence between pixels that are on at all times versus pixels that are not. This could result in pixels exhibiting a burned-in effect. To minimize the burned-in effect, a screen saver function can be activated by programming the *SCREEN SAVER* menu selection to ON. With the screen saver function turned on, the display appearance changes every 12 hours. The display will appear in the normal mode with a dark background color for the first 12 hours and will then switch to a back-lit background color for the next 12 hours. If you like to have the 12 hour period for the normal display mode to start at a specific time of the day, simply access the *SCREEN SAVER* menu and change setting to OFF and then ON again. This initiates the screen saver function immediately.

5.8.2 SETUP UNIT**- UNITS** [Factory default = TORR]

Select from TORR, mBAR or PASCAL. Units selected are used for all other settings.

- DEFAULTS [Factory default =MENU TO EXIT]

The module can be returned to the original factory settings by using the ENTER Key to set factory defaults. **Note** - You must re-enter the actual sensor SENSITIVITY value marked on the sensor and reprogram other parameters as required.

- GAS TYPE [Factory default = N2]

Use the UP and DOWN Keys to select from a table of 16 commonly used gases. Gas choices are: N₂, Air, O₂, CO, H₂O, NO, Ar, CO₂, Kr, SF₆, Xe, Hg, He, Ne, D₂, and H₂.

 **CAUTION!** If you intend to use nitrogen as the default gas setting even though the gas in use is not nitrogen, you can select N₂ from the menu, but you must manually apply a gas correction factor to the displayed measurement and outputs (Refer to [section 6](#) titled “Using the gauge with different gases”).

- CLR IG ERROR [Factory default = OFF]

When the IGM401 ionization gauge (IG) experiences an error condition such as OVERPRESSURE, emission failure, etc., the ion gauge filament will turn off and the module will stop measuring pressure. Error messages will be displayed on the IGM401 screen showing the error. This is intended to prompt the user to determine what the error condition is before the filament can be turned on again. Once the cause of the error has been determined and resolved, the error must be cleared before the filament can be turned on again. The CLR IG ERROR allows the user to clear the IG error using the front panel push buttons, regardless of whether the IG CNTL mode below is set to Front Panel, Digital Input (DIGI) or RS485.

- OVER PRES 100 [Factory default = 5.00E-02 TORR]

This allows the user to set a pressure value at which the IG filament will automatically turn off when the emission current is operating at 100 µA. No value higher than 5.00E-02 Torr, equivalent, can be set.

Note - The user does not have the choice to select a turn off point for the IG filament when the emission current selected is 4 mA. The IG filament turn off is always set to 1 x 10⁻³ Torr when the emission current setting is 4 mA. When the 4 mA emission current setting is selected the pressure must be at 1 x 10⁻³ Torr or less before the IG filament can be turned on.

- IG CNTL [Factory default = DIGI/RS485]

This allows the user to choose the source of control for the IG. The IG can be controlled via digital inputs, RS485 commands or front panel.

➤ *DIGI/RS485*

The DIGI/RS485 allows the application of either digital inputs or RS485 communication commands to operate the IGM401. The default state of the DIGI/RS485 selection is digital input (*DIGI*). This control mode requires grounding pin 1 of the 9-pin D-sub male (DE-9P) ANALOG connector to turn the IG filament to ON and activate the sensor.

The user should verify the *DIGI/RS485* is selected in the IG CNTL submenu of the SETUP UNIT menu. When operating in the Digital Input (*DIGI*) mode, the IG filament can only be turned on by continuously connecting circuit ground (pin 2) to pin 1 of the DE-9P ANALOG connector. Degas and emission current selection can also be set using the digital inputs available on the DE-9P ANALOG connector. Connect the ANALOG connector pins 2 and 8 together to change from an emission current of 100 µA to 4 mA. See [section 3.3.2.1](#), ANALOG connector pin-out for details related to Digital I/O connections. Connecting ANALOG connector contact pin 6 to pin 2 will assert DEGAS when the IG filament is in the ON state. An external control device like a PLC may be used to set pin

1 to ground (circuit common) as long as the PLC circuit common (ground) is tied to the IGM401 ANALOG connector pin 2.

To change from DIGI to RS485 communication mode, use the 9-pin RS485 D-sub female (DE-9S) connector to connect the DATA A (-) and DATA B (+) RS485 signal lines. The user should verify DIGI/RS485 is selected in the *IG CNTL* submenu of the SETUP UNIT menu.

In order for the IGM401 to operate in the in the RS485 mode, the user must send a command to turn the IG to OFF. If you have already turned the IG ON in the default DIGI mode and you send the IG OFF command via RS485 to auto switch from DIGI to RS485 mode, the IG will turn OFF. If the RS485 command to turn IG ON is sent, then the IG will stay in the ON state and the control mode will be auto switched to RS485.

The program code control logic is such that when switching from DIGI controls to RS485 controls, the device will invoke a 'safe state' if any RS485 command is sent to switch from DIGI to RS485. A command sent to the IGM401 such as IG ON/OFF, DEGAS ON/OFF or SET ION GAUGE EMISSION CURRENT will cause the IGM401 to automatically switch from the DIGI mode to the RS485 control mode. Sending **READ** commands such as read gauge pressure will not accomplish this task. When operating in the RS485 mode, all other inputs are ignored (i.e., the host has control).

Note - To change from the RS485 to another IG CNTL mode, the reset command must be sent to the IGM401 or power must be turned off and on. This will reset IG CNTL to the DIGI/RS485 factory default setting with the default state of this selection being the Digital Input (*DIGI*) again.

➤ **FRONT PANEL**

This mode of operation allows the user to manually turn the IG filament on/off, select emission current and turn degas on/off using the front panel soft-keys. This is achieved by selecting FRONT PANEL in the IG CNTL submenu of the SETUP UNIT menu. In this case the FRONT PANEL overrides any other input and the *DIGI/RS485* inputs are ignored. If FRONT PANEL is selected, the following Top-Level Program Menu will be displayed after the MENU key is pressed. Compare the following program selection menu to the selection choices shown at [section 5.7](#) for default program parameters and settings.

- *Top-Level Program Menu when FRONT PANEL is selected for IG CNTL:*

IG ON^(A)
 IG OFF^(A)
 SETUP DISP
 SETUP UNIT
 SETUP IG
 ANALOG OUTPUT
 SETUP COMMS
 SERVICE MENU
 EMISSION SEL^(B)
 DEGAS OFF^(C)
 DEGAS ON^(C)

^(A) **IG ON/OFF** [Factory default = OFF] If the IG is in the default OFF state, select the IG ON line in the displayed menu and then press ENTER to turn the IG ON. The device will respond immediately to either entry of IG ON or IG OFF when selected and ENTER is pressed.

^(B) **EMISSION SEL** [Factory default = 100UA] Access setting to change emission current to 4 mA or 100 μ A.

^(C) **DEGAS ON/OFF** [Factory default = OFF] Access setting to turn degas on or off. Degas operation may be invoked immediately when the IG filament is in the ON state by pressing the ENTER key after selecting DEGAS ON in the main TOP-LEVEL Program Menu. The device will respond immediately after the ENTER key is pressed for either DEGAS ON or DEGAS OFF.

5.8.3 SETUP IG

- **DEGAS TIME** [Factory default = 2]

The length of time in minutes degassing will run after it is initiated. Degas cycle can be selected from 2 to 10 minutes.

- **SENSITIVITY** [Factory default = Actual Sensor sensitivity (nominal = 8-15)]

The actual sensitivity value of each ion gauge sensor is marked on the end plate below the electronic enclosure. The sensitivity value is designated with the letter "S" and it is a number that normally ranges between 8 and 15. The actual sensitivity value of the ion gauge sensor is programmed in the electronics at the factory prior to shipment. The sensitivity value may be adjusted by the user from 2 to 99. Ion gauge pressure readings are calibrated for nitrogen. If you use a different species of gas or mixture of gases other than the 16 gases listed under the GAS TYPE submenu of the SETUP UNIT menu, you will be required to either make manual corrections to the pressure readout or compensate the reading. The sensitivity adjustment function of the IGM401 you are using to measure the pressure of a gas other than nitrogen/air may be set to compensate the reading. Compensating the pressure reading using the sensitivity adjustment method may not be possible for certain gases if the sensitivity correction factor results in a calculated sensitivity outside the adjustment range. **User assumes all risks if sensitivity is set to a value different than the actual sensor sensitivity.**

- **FILAMENT NUM** [Factory default = FILAMENT 1]

Allows user to select which filament to operate: *Filament 1* or *Filament 2*

Note - When using yttria coated filaments, it is highly recommended to periodically alternate operating Filaments 1 and 2. An inactive filament not operating for an extended length of time may result in that filament failing to establish emission current when it is eventually used, especially in dirty applications.

- **RLY I LO TRP** [Factory default = 1.00E-06 TORR]

The relay is energized when pressure reaches this setpoint.

If RLY I LO TRP is programmed to a lower value than RLY I HI TRP, relay will energize when pressure drops below the RLY I LO TRP setting. Relay will then de-energize when pressure rises above RLY I HI TRP.

If RLY I LO TRP is programmed to a higher value than RLY I HI TRP, relay will energize when pressure rises above the RLY I LO TRP setting. Relay will then de-energize when pressure drops below RLY I HI TRP.

The range of adjustment for setpoint pressure is 1.00E-11 to 3.00E-02 Torr. Setting the setpoint pressure below 1.00E-09 Torr may not be useful since the device has a low end measurement capability of 1.00E-09 Torr.

Note - If you have an older version of IGM401 with firmware number 1769-107 or lower (See INFO submenu in SERVICE MENU screen) the RLY I LO TRP setpoint corresponds to the turn on point for the relay. The relay will turn on when the pressure drops below this setting. With this older version of the firmware you will not be able to set the RLY I LO TRP value higher than the RLY I HI TRP. If you try to set the RLY I LO TRP to a value higher than RLY I HI TRP, the IGM401 will revert back to the original RLY I LO TRP value. To do this correctly so that the IGM401 will accept the new setting for the RLY I LO TRP, you must first select the RLY I HI TRP listed below and increase that value to a number higher than the value of RLY I LO TRP you are trying to set.

- **RLY I HI TRP** [Factory default = 5.00E-06 TORR]

The relay is de-energized when pressure reaches this setpoint.

If RLY I HI TRP is programmed to a higher value than RLY I LO TRP, relay will de-energize when pressure rises above the RLY I HI TRP setting. Relay will energize when pressure drops below RLY I LO TRP.

If RLY I HI TRP is programmed to a lower value than RLY I LO TRP, relay will de-energize when pressure drops below RLY I HI TRP setting. Relay will then energize when pressure rises above RLY I LO TRP.

The range of adjustment for setpoint pressure is 1.00E-11 to 3.00E-02 Torr. Setting the setpoint pressure below 1.00E-09 Torr may not be useful since the device has a low end measurement capability of 1.00E-09 Torr.

Note - If you have an older version of IGM401 with firmware number 1769-107 or lower (See INFO submenu in SERVICE MENU screen) the RLY I HI TRP setpoint corresponds to the turn off point for the relay. The relay will turn off when the pressure rises above this setting. With this older version of the firmware you will not be able to set the RLY I HI TRP value lower than the RLY I LO TRP. If you try to set the RLY I HI TRP to a value lower than RLY I LO TRP, the IGM401 will revert back to the original RLY I HI TRP value. To do this correctly so that the IGM401 will accept the new setting for the RLY I HI TRP, you must first select the RLY I LO TRP listed above and decrease that value to a number lower than the value of RLY I HI TRP you are trying to set.

- **RELAY I TEST** [Factory default = OFF]

This allows the user to manually toggle the relay on and off to test for correct external circuit wiring and ensure polarity is as desired.

- **FIL USAGE** [Factory default = all at zero]

This allows the user to view how many hours each filament has been turned on and how many hours degassing has been applied to each filament. The display in this screen provides the following data:

F1: # H (Number of hours filament 1 has been in use).
F2: # H (Number of hours filament 2 has been in use).
D1: # H (Number of hours filament 1 has been degassed).
D2: # H (Number of hours filament 2 has been degassed).

The F1 and F2 hours of use are factory set to 0.0H after initial device burn-in, test and calibration.

- **AUTO IE EN** [Factory default = DISABLE]

This allows the user to enable or disable the automatic emission current switching feature of the instrument.

- **AUTO IETRIP** [Factory default = DISABLE]

The default setting is *DISABLED* if AUTO IE EN above is set to *DISABLE*. If AUTO IE EN is set to *ENABLE*, then AUTO IE TRIP value allows the user to select the pressure at which the auto switching of the emission current takes place. The user has the choice of programming the AUTO IE TRIP point anywhere between 1.00E-06 to 1.00E-04 Torr.

Example: If AUTO IE TRIP point is set to 1.00E-05 Torr, then the ion gauge can operate at an emission current of 100 μ A over a pressure range of 5.00E-02 Torr to 1.00E-05. The emission current will then automatically switch to 4 mA for pressure ranges below 1.00E-05 Torr.

5.8.4 ANALOG OUTPUT

- **IG ANALOG CAL** [Factory default = *Factory Set*]

This has been pre-set in the factory and is used to optimize the analog output calibration. It is recommended that the user **not** make this adjustment unless the displayed pressure on the Hornet and the resulting pressure recorded from the analog output do not match closely.

To perform the analog output calibration, connect the analog output to a high resolution voltmeter, your system, PLC, etc. Evacuate your vacuum system to a low enough pressure for the IG to operate. Establish a system pressure so that the displayed IG reading is preferably at the high end of any decade (for example 9.00E-05 as opposed to 1.00E-05). Press the ENTER key when in the *IG ANALOG CAL menu* to see the next screen which allows you to calibrate the analog output. Use the UP or DOWN keys to adjust the analog output to match the corresponding displayed pressure.

Example: After pressing the ENTER key in the *IG ANALOG CAL* menu the next screen (analog output calibration screen) is displaying a pressure of 9.00E-05 Torr. Based on the equation and table given in [section 7](#) the expected analog output at 9.00E-05 Torr is 5.9542 V. Use the UP or DOWN keys to set the analog output to 5.9542 V as recorded by your voltmeter. Alternatively, if the IG analog output is used to display the IG pressure on your PLC or system display console, simply use the UP or DOWN keys so that the IG pressure displayed by your PLC (pressure established at the high end of any decade preferred) matches the IG pressure displayed in the analog output calibration screen. When done press the ENTER key to save the settings. Note - As you adjust the analog output, the number you are changing in the analog output calibration screen represents the millivolts offset from zero volts that is being used internally for the analog output gain adjustment.

5.8.5 SETUP COMMS

- **BAUD RATE** [Factory default = 19200, 8, N, 1]

This sets the baud rate for the RS485 communications. The baud rate can be set to other values manually using the front panel soft-keys.

- **ADDR** [Factory default = 1]

This is the lower nibble of the one byte RS485 device address. Assuming the address offset (ADDR OFFSET) is equal to 0, setting the ADDR to a 5 will make the address be 0x05 in hexadecimal. A 15 in decimal will set the ADDR to 0x0F in hexadecimal.

- **ADDR OFFSET** [Factory default = 0]

This is the upper nibble of the one byte RS485 address. Assuming the address (ADDR) is 0, setting the address offset (ADDR OFFSET) to a 5 will make the address be 0x50 hexadecimal. Setting the offset to 16 will make the address be 0x10 hexadecimal (see following table).

-----BINARY ADDRESS-----			
ADDRESS DECIMAL	-----ONE BYTE----- (BINARY)		ADDRESS HEXADECIMAL
	ADDR OFFSET ┌Upper nibble┐	ADDR ┌Lower nibble┐	
1	0 0 0 0	0 0 0 1	01
5	0 0 0 0	0 1 0 1	05
15	0 0 0 0	1 1 1 1	0F
16	0 0 0 1	0 0 0 0	10

5.8.6 SERVICE MENU

- **INFO**

This screen provides the installed firmware version number. For example, when this menu choice is selected, a number such as '2444-100' may be displayed. The firmware part number is '2444' and the version is '100'.

- **OP TIME**

This screen provides information on how long the unit has been powered on regardless of filament operation.

5.9 Activating the sensor

Before you turn on the IG filament and activate the sensor, make sure you understand all instructions and information provided in this user manual. You can activate the sensor by one of the following methods:

- 1) Front Panel (Manually using front panel soft-keys - see IG CNTL and FRONT PANEL in [section 5.8.2](#))
- 2) Digital Input (see IG CNTL in [section 5.8.2](#))
- 3) RS485 commands (see IG CNTL in [section 5.8.2](#))
- 4) Using a Convection gauge relay to activate the hot cathode sensor – Digital Input mode

Because the useful operating range of the InstruTech's hot cathode IGM401 is from 1.00×10^{-9} Torr to 5.00×10^{-2} Torr, another vacuum gauge capable of measuring pressures above 5.00×10^{-2} Torr should be used to determine when to turn on the IG filament and activate the sensor. This can simply be a manual operation by the operator using the programming soft keys, or automated by having the IGM401 in the Digital Input mode and using control signals from another gauge such as an InstruTech convection enhanced pirani (CG) gauge. The latter is a recommended method of operating the hot cathode gauge. For example, you may use an InstruTech CVM211 *Stinger™* or the CVM201 *Super Bee™* convection gauge to activate or deactivate the hot cathode sensor. The setpoint relay from the CVM211 or CVM201 can be physically wired to the hot cathode ANALOG connector. (See typical connection scheme below) The relays in the CVM211 or CVM201 can be configured to energize at the desired pressure at which the hot cathode sensor will be activated. The hot cathode sensor is activated (operational) by applying a continuous ground thru the relay connections of the CVM211 or CVM201. The sensor is deactivated when relay is de energized discontinuing the application of ground.

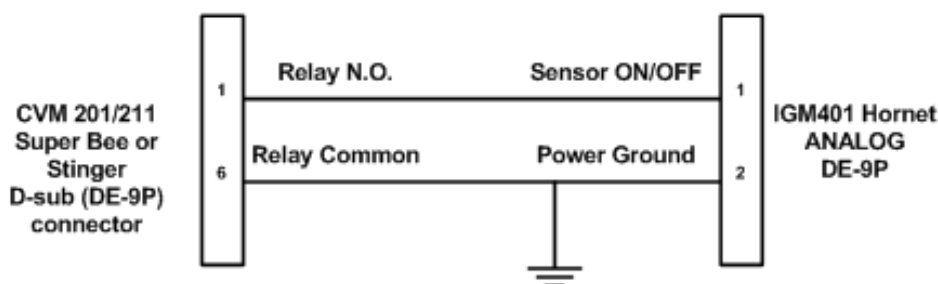

Using a convection gauge to activate the hot cathode sensor

Note - It may take up to 8 seconds for the IGM401 transducer filament to turn on after it has received a turn on command via the front panel push button, Digital Inputs, or RS485 command control modes. The ion gauge measurement screen may display “UNIT STATUS OFF” during the time that the IGM401 is starting the emission and stabilizing the measurements.

6 Using the gauge with different gases

InstruTech gauge transducers and modules are calibrated for nitrogen gas.

Read the following information very carefully if you intend to use a gas other than nitrogen or air.

The IGM401 offers the user the choice to use the factory default gas type N₂ or select from a table of 16 most commonly used gases in the menu.

1) Selecting a specific gas other than nitrogen

If a specific gas other than N₂ is selected from the menu, the IGM401 will automatically apply the conversion factor to the measurement. The specific gas symbol will also be displayed along with its measurement value. In this case no correction factor needs to be applied to the IGM401 measurements. **The user must ensure all operators are aware the display measurement represents the true measurement value specific to the selected gas.**

2) Using nitrogen as the default gas

If you intend to use nitrogen as the default gas even though the gas in use is not nitrogen, you can select N₂ (nitrogen) from the menu, but you must manually apply a gas correction factor to the displayed measurement and analog output. Post a label on your ion gauge display showing the correction factor if you intend to select nitrogen as the gas and apply manual correction factors versus selecting specific gases from the menu. The following table provides some typical correction factors. To correct the measurements, divide the measured pressure by the correction factors:

Gas Correction Factors

Gas	Gas Correction Factor
He	0.18
Ne	0.30
D ₂	0.35
H ₂	0.46
N ₂	1.00
Air	1.00
O ₂	1.01
CO	1.05

Gas	Gas Correction Factor
H ₂ O	1.12
NO	1.16
Ar	1.29
CO ₂	1.42
Kr	1.94
SF ₆	2.50
Xe	2.87
Hg	3.64

Example:

A) The IGM401 is selected for nitrogen. The gas in use is argon. The measured pressure is displayed at 1.00×10^{-6} so the actual pressure of argon is:

$$P(\text{argon}) = \frac{1.0 \times 10^{-6}}{1.29} = 7.75 \times 10^{-7} \text{ Torr true pressure of argon gas}$$

The correction factor must be applied to both the display and analog output over the entire pressure range measured by the ion gauge.

7 Analog Output

A) The log-linear output signal and pressure are related by the following formulas when units of measurement is in **Torr** and **mbar**:

$$P = 10^{(\text{volts} - 10)} \quad V = \log_{10}(P) + 10$$

Where P is the pressure in Torr or mbar, and V is the output signal in volts.

B) The log-linear output signal and pressure are related by the following formulas when units of measurement is in **pascals**:

$$P = 10^{(\text{volts} - 8)} \quad V = \log_{10}(P) + 8$$

Where P is the pressure in Pascals, and V is the output signal in volts.

The output voltage is zero when pressure is at 1.0E-10 Torr.

Notes - The output voltage will switch to above +10 Vdc under the following conditions:

- 1) The filament is turned off or any IG fault condition.
- 2) The pressure exceeds 1.00×10^{-3} Torr at 4 ma emission current.
- 3) The pressure exceeds 5.0×10^{-2} Torr at 100 μ A emission current.

Log-Linear Analog Output

Pressure (Torr)	Voltage
1.0E-10	0.0
1.0E-09	1.0
1.0E-08	2.0
1.0E-07	3.0
1.0E-06	4.0
1.0E-05	5.0
1.0E-04	6.0
1.0E-03	7.0
1.0E-02	8.0
5.0E-02	8.698
See Notes	≥ 10

The following chart shows the graphical results of table and formulas above. Pressure is plotted on the X-axis with a log scale; the output signal is plotted on the Y-axis on a linear scale.

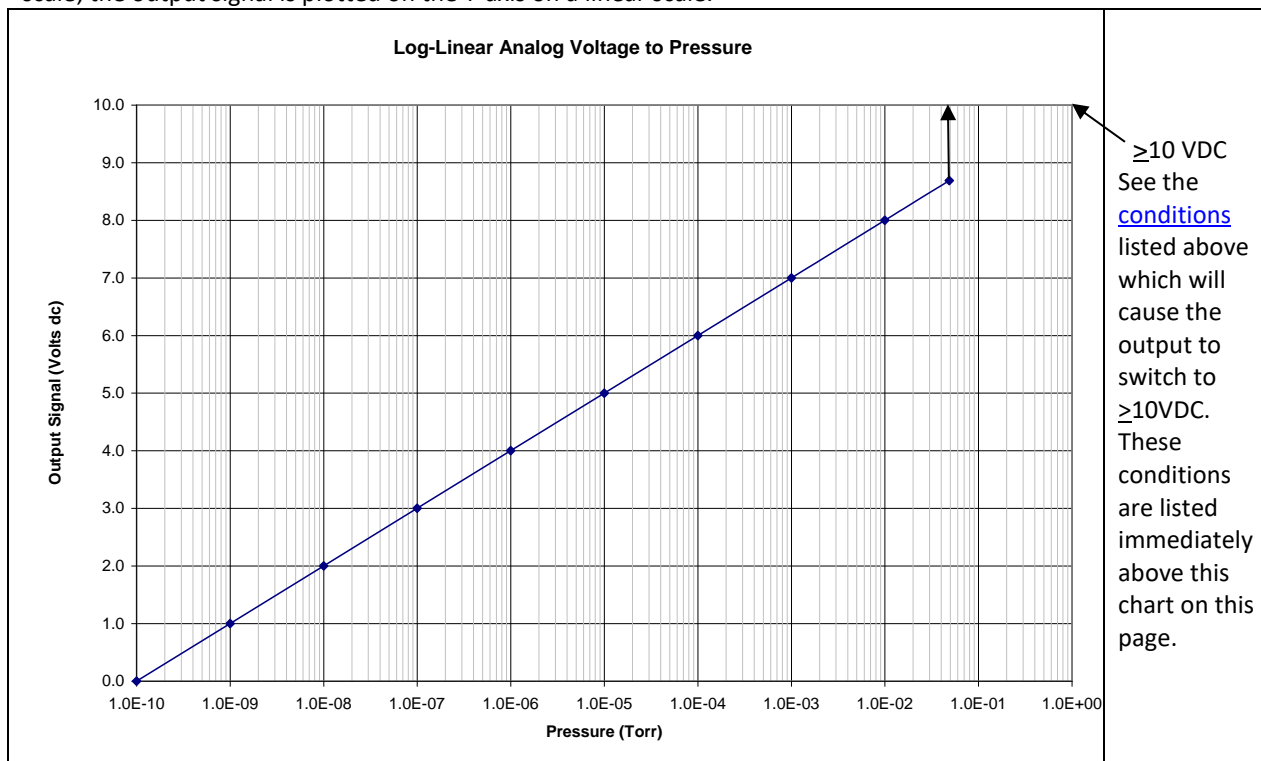

8 RS485 serial communications

8.1 Device Specific Serial Communication Info

The standard IGM401 model provides RS485 serial communications. The following information and the RS485 command protocol summary listed on the next page can be used to establish serial communications with the device.

1. Default settings are **19,200** baud rate, **8** data bits, **No Parity**, **1** stop bit [Factory default; 19,200, 8, N, 1].
2. The baud rate can be set to different values using the front panel soft-keys.
3. Minimum interval between commands sent out over the RS485 bus is 50 msec.
4. The stop bit is always 1.
5. All Responses are 13 characters long.
6. 'xx' is the address of the device (00 thru FF).
7. <CR> is a carriage return, a non-printable character. Do not enter <CR> from your keyboard. A carriage return, non-printable character may be entered as the Unicode C0 controls specified value: 0D hexadecimal (13 decimal). From your keyboard, a key entry sequence of CNTL-M may be used to obtain the required character for a carriage return when using certain terminal emulator programs.
8. ' ' represents a 'space' character. Press the space bar on your keyboard. Do not enter a ' _ ' (underscore) character.
9. The 'z' in the set or read trip point commands is a plus (+) or minus (-). The plus (+) is the 'turns on below' setpoint and the minus (-) is the 'turns off above' setpoint.
10. All commands sent to the module start with a '#' character, and all normal responses from the module start with a '*' character. Error responses start with a "?".
11. A valid address must be used [Factory default = 1]. The IGM401 will not respond to a command with an invalid address.
12. The command syntax examples used in the protocol summary table for ASCII are shown in scientific notation. However, floating point notation is acceptable as long as a leading digit is entered as '0.' or '1.', etc. There must be a digit to the left of the decimal point. For example, when constructing the syntax for the command to set the CGn zero value (e.g., #xxTZn_x.xxE-pp<CR> when using scientific notation), use either #xxTZn_0.00<CR>, or #xxTZn_0<CR>. A simple '0' is valid for the pressure entry.

8.2 RS485 Command Protocol Summary

COMMAND	BRIEF DESCRIPTION	COMMAND SYNTAX	RESPONSE
READ ION GAUGE PRESSURE	Read the current displayed pressure of the ion gauge in Torr	#xxRD<CR> (e.g., #01RD<CR>) where xx = the two digit address of the device (node)	*xx_y.yyEzzy<CR> where y.yy = mantissa, z = sign of the exponent, i.e., +/- and pp = the exponent. (e.g., *01_1.53E-06<CR>) When IG is off: *01_9.90E+09<CR>
SET ADDR OFFSET	Set the communications (RS485) address offset (upper nibble) ⁽¹⁾	#xxSAuu<CR> (e.g., #01SA10<CR>) where uu=00 or 10 or 20 or 30	*xx_PROGM_OK<CR>
TURN IG ON/OFF	Power up the filament and start reading pressure.	#xxIGy<CR> (e.g., #01IG1<CR>) y=1=Turn ON y=0 Turn OFF	*xx_PROGM_OK<CR> y=0=IG OFF (clears any IG errors)
TURN DEGAS ON/OFF	Start a degas cycle or turn off degas.	#xxDGy<CR> (e.g., #01DG1<CR>) Y=1= Turn ON y=0= Turn OFF	*xx_PROGM_OK<CR>
SET EMISSION CURRENT	Choose either 4mA or 100 µA emission current.	#xxSEy<CR> (e.g., #01SE1<CR>) y=1=4mA y=0=100µA	*xx_PROGM_OK<CR>
SET FILAMENT	Choose Filament 1 or 2.	#xxSFy<CR> (e.g., #01SF1<CR>) y=1 for F1 y=2 for F2	*xx_PROGM_OK<CR>
SET OVER PRESSURE SETPOINT	Set 100 µA overpressure turn-off point.	#xxSOy.yyE-yy<CR> (e.g., #01SO4.00E-02<CR>)	*xx_PROGM_OK<CR>
SET TRIP POINT FOR RELAY I	Set the 'turns on below' (+) pressure point for relay I and set the 'turns off above' (-) pressure point for relay I.	#xxSLzy.yyEzyy<CR> (e.g., #01SL+4.00E+02<CR>) (e.g., #01SL-5.00E+02<CR>) For the 'z' preceding the 'y.yy' value, a '+' = 'turns on below' the setpoint pressure and a '-' = 'turns off above' the setpoint pressure for RLY I	*xx_PROGM_OK<CR> If the 'turns off above' (-) pressure setpoint is less than the value of the 'turns on below' (+) setpoint, an error message of ?01 SYNTAX ER<CR> will result.
READ IG ON/OFF STATUS	Find out if filament is powered up and gauge is reading.	#xxIGS<CR> (e.g., #01IGS<CR>)	*xx_0_IG_OFF<CR> *xx_1_IG_ON_<CR>

COMMAND	BRIEF DESCRIPTION	COMMAND SYNTAX	RESPONSE
READ TRIP POINT for RLY I	Read the 'turns on below' pressure point for RLY I and read the 'turns off above' pressure point for RLY I.	#xxRLZ<CR> (e.g., #01RL+<CR>) (e.g., #01RL-<CR>)	*xx_y.yyEzzy<CR> (e.g., *01+2.60E-06<CR>) (e.g., *01-7.60E-06<CR>)
READ DEGAS STATUS	Find out if the module is currently degassing.	#xxDGS<CR> (e.g., #01DGS<CR>)	*xx_0_DG_OFF<CR> *xx_1_DG_ON_<CR>
READ EMISSION CURRENT STATUS	Find out emission current level.	#xxSES<CR> (e.g., #01SES<CR>)	*xx_0.1MA_EM<CR> *xx_4.0MA_EM<CR>
READ IG MODULE STATUS	Finds out the cause of the controller shutdown ⁽²⁾	#xxRS<CR> (e.g., #01RS<CR>)	*xx_00_ST_OK<CR> *xx_01_OVPRS<CR> *xx_02_EMISS<CR> *xx_08_POWER<CR> *xx_20_ION_C<CR> ⁽³⁾
READ SW VERSION	Read the part number and revision number (version) of the firmware.	#xxVER<CR> (e.g., #01VER<CR>)	*xx_mmmm-vv<CR> e.g., *01_001769-103<CR>
SET FACTORY DEFAULTS	Force unit to return ALL settings back to the way the factory programmed them before shipment. ⁽¹⁾	#xxFAC<CR> (e.g., #01FAC<CR>)	*xx_PROGM_OK<CR>
SET BAUD RATE	Set the communications baud rate for RS485. ⁽¹⁾	#xxSByyyyy<CR> (e.g., #01SB19200<CR>)	*xx_PROGM_OK<CR>
SET NO PARITY	Set the communications to NO parity, 8 bits for the RS485. ⁽¹⁾	#xxSPN<CR> (e.g., #01SPN<CR>)	*xx_PROGM_OK<CR>
SET ODD PARITY	Set the communications to ODD parity, 7 bits for the RS485. ⁽¹⁾	#xxSPO<CR> (e.g., #01SPO<CR>)	*xx_PROGM_OK<CR>
SET EVEN PARITY	Set the communications to EVEN parity, 7 bits for the RS485. ⁽¹⁾	#xxSPE<CR> (e.g., #01SPE<CR>)	*xx_PROGM_OK<CR>
UNLOCK COMM PROGRAMMING (UNL)	If the UNL command is enabled by the TLU command, the UNL command must be executed in sequence prior to the SB, SPN, SPO, and SPE commands. Not sending the UNL will yield a response of ?xx_COMM_ERR<CR>. If UNL is not enabled, then a response would be ?xx_SYNTAX_ER<CR>.	#xxUNL<CR> (e.g., #01UNL<CR>)	*xx_PROGM_OK<CR>

COMMAND	BRIEF DESCRIPTION	COMMAND SYNTAX	RESPONSE
TOGGLE UNL FUNCTION (TLU)	The TLU command will toggle the state of the UNL function. When the response is UL_ON, then UNL is required to execute SB, SPN, SPO, and SPE. When response is UL_OFF, then UNL is not required and sending a UNL will generate a ?xx_SYNTAX_ER<CR>.	#xxTLU<CR> (e.g., #01TLU<CR>)	*xx_1_UL_ON_<CR> *xx_0_UL_OFF<CR>
RESET	Reset the device as if power was cycled (Required to complete some of the commands.)	#xxRST<CR> (e.g., #01RST<CR>)	No response

⁽¹⁾ Commands marked with a ⁽¹⁾ under the “BRIEF DESCRIPTION” column will not take effect until after the RESET command is sent or power is cycled. This protocol was designed to be compatible with the Granville-Phillips® Series 354 Micro-Ion®.

⁽²⁾ After power is cycled, the first #xxRS<CR> query will return a *xx_08_POWER<CR>. A second #xxRS<CR> query will return *xx_00_ST_OK<CR>. Now, if, for example, power was cycled and an EMIS FAIL error occurred when a subsequent IG ON condition was attempted, the response to the #xxRS<CR> query will be the sum of the ‘08’ for Power and ‘02’ for EMIS FAIL in hexadecimal or ‘0A’. In other words, the response to the #xxRS<CR> command sent after the power cycle and emission failure events occurred will be *xx_0A_EMISS<CR>.

⁽³⁾ The ‘*xx_20_ION_C<CR>’ response to an Ion Current failure error is not a response available with G-P Micro-Ion® products.

NOTE:

Either floating point notation, or scientific notation may be used in the commands which require a pressure value entry; either may be used. When using float values, be sure to place a numeral in the placeholder immediately to the left of the decimal point.

Depending on the age of your device the following new additional commands showing the filament condition may not be available with your unit. If your device does not respond to the following commands it does not have these latest additions. The last four parameters shown below provide the same type of information when the setup and programming display screen is set to the RESEARCH mode.

COMMAND	BRIEF DESCRIPTION	COMMAND SYNTAX	RESPONSE
READ PRESSURE UNIT	Read pressure unit	#xxRU<CR> (eg: #01RU<CR>)	*xx_TORR____<CR> *xx_MBAR____<CR> *xx_PASCAL__<CR>
SET PRESSURE UNIT	Set Pressure unit for display and RD response	#xxSUx<CR> (eg: #01SUT<CR>)	*xx_PROGM_OK<CR> T = Torr, M = mBar, P = Pascal
READ IG ION CURRENT	Read the current IG ion current in amps	#xxRDIGC<CR> (eg: #01RDIGC<CR>)	*xx_y.yyEzzy<CR> (eg: *01_1.53E-06<CR>) When sensor is off: indicate offset voltage.
READ IG EMISSION CURRENT	Read the actual IG emission current being measured by the gauge in amps	#xxRDIGE<CR> (eg: #01RDIGE<CR>)	*xx_y.yyEzzy<CR> (eg: *01_1.00E-04<CR>) When sensor is off: 0.00E-00
READ IG FILAMENT VOLTAGE	Read the current IG filament voltage in volts	#xxRDIGV<CR> (eg: #01RDIGVCR>)	*xx_y.yyEzzy<CR> (eg: *01_1.20E-00<CR>) When sensor is off: 0.00E-00
READ IG FILAMENT CURRENT	Read the current IG filament current in amps	#xxRDIGA<CR> (eg: #01RDIGACR>)	*xx_y.yyEzzy<CR> (eg: *01_2.20E-00<CR>) When sensor is off: 0.00E-00

9 Service

9.1 Calibration

Every InstruTech module is calibrated prior to shipment using nitrogen. Care should be exercised when using gases other than nitrogen (N₂) / air (see [Section 6](#) titled “Using the gauge with different gases”).

9.2 Troubleshooting - Operation

<i>Indication</i>	<i>Possible Cause</i>	<i>Possible Solution</i>
Display is off / blank	No power The connector may not be wired correctly	Check cable connections and verify that power is being supplied Check cable connections and verify that power is being supplied
Readings appear very different from expected pressure	Sensor not in the proper location to measure system pressure The process gas is different from the gas (Nitrogen) used to calibrate the IGM401 Sensor has been dropped causing mechanical damage The gauge sensor tube is contaminated Leak in the vacuum system	Ensure the sensor is located in appropriate location Apply gas correction factor if applicable or select the appropriate gas from the IGM401 display menu Replace the ion gauge sensor tube Degas the sensor or replace the sensor Re-check for leak in the system; re-check that all metal seals are used when operating below 1.0×10^{-7} Torr
Ion gauge cannot be turned on	Pressure exceeds 1.00×10^{-3} Torr at 4 mA emission Pressure exceeds 5.0×10^{-2} Torr at 0.10 mA (100 μ A) emission Emission Control not functioning	Decrease pressure below required value Decrease pressure below required value Switch to the other filament replace ion gauge sensor tube due to possible filament failure or contamination
Research Screen shows filament Voltage is present but filament current stays at 0	Filament is open	Switch to the other filament, replace sensor or electronics
Research Screen shows filament voltage and filament current are present but gauge is shutting off	Filament is contaminated or burned out	Switch to the other filament or replace sensor
Unable to initiate degas	System pressure above 5.0×10^{-5} Torr	Decrease pressure below the required value
Voltage to filament too high	Filament contaminated or near end of its life	Switch to the other filament or replace sensor
Setpoint does not actuate	Incorrect setup	Check setpoint setup

9.3 Troubleshooting - Error Messages

<i>Indication</i>	<i>Possible Cause</i>	<i>Possible Solution</i>
OVERPRESSURE	The calculated pressure is greater than maximum setting for emission current. System pressure too high	Change to 100 μ A emission current which will operate at higher pressures or reduce pressure
ION CUR FAIL	The ion current (IC) is below the minimum parameter. Sensor contamination, possible coating on collector inhibiting ion collection Electrometer failure	Determine source of contamination Replace the ion gauge sensor tube Contact InstruTech
EMIS FAIL	The desired emission current (IE) could not be established. Gauge contamination, possible coating on filament or grid surfaces. End of filament life System pressure too high	Switch to 4 mA emission current and attempt repeated filament starts to clean filament Switch to second filament, degas Replace the ion gauge sensor tube Reduce pressure
LV Failure	The Filament voltage could not be established. Electronics Failure	Contact InstruTech
LV OVR PWR	The power applied to the filament is at maximum without establishing an emission current	Contact InstruTech
F1 or F2 OPEN	Filament 1 or 2 is open	Switch to the other filament or replace the ion gauge sensor transducer (IG4yx)
F1 or F2 OPEN	Faulty electronics	Replace electronics

Note:

Once the cause of the IG error has been determined and resolved the IG error must be cleared before the IG filament can be turned on again. The method by which the error is cleared is dependent on the IG CNTL submenu of the SETUP UNIT menu selected. The IG error can be cleared by one of the following three methods:

- 1) If Input control menu (IG CNTL) is set to DIGI (digital Input), then remove ground connection (PIN 2) from PIN 1 of the analog connector. Next, apply ground to Pin 1, i.e., reconnect pin 1 to pin 2 of the ANALOG connector to turn the IG filament on.
- 2) If Input control menu (IG CNTL) is set to RS485, then send an off command to clear the error. Next, send an on command to turn the IG filament on.
- 3) If Input control menu (IG CNTL) is set to FRONT PANEL, first access the CLR IG ERROR submenu of SETUP UNIT menu. Press Enter to clear the error and exit. Next, turn on the IG filament in the FP OPERATE submenu of the SETUP UNIT menu.

9.4 Troubleshooting - Filaments F1 or F2 open

If a filament is open, then trying to start the filament will result in error messages “F1 or F2 open” or similar displayed error messages. This error may be an indication of open filaments but in some cases it could also be an indication of faulty electronics.

To determine whether the problem is caused by either a failed filament or the electronics, refer to [section 9.8](#) and follow instructions to remove the ion gauge transducer from the control module. Measure the resistance (electrical continuity) of filaments 1 and 2 as shown below. A good, intact filament will indicate a resistance of 0.2 ohms on your ohmmeter.

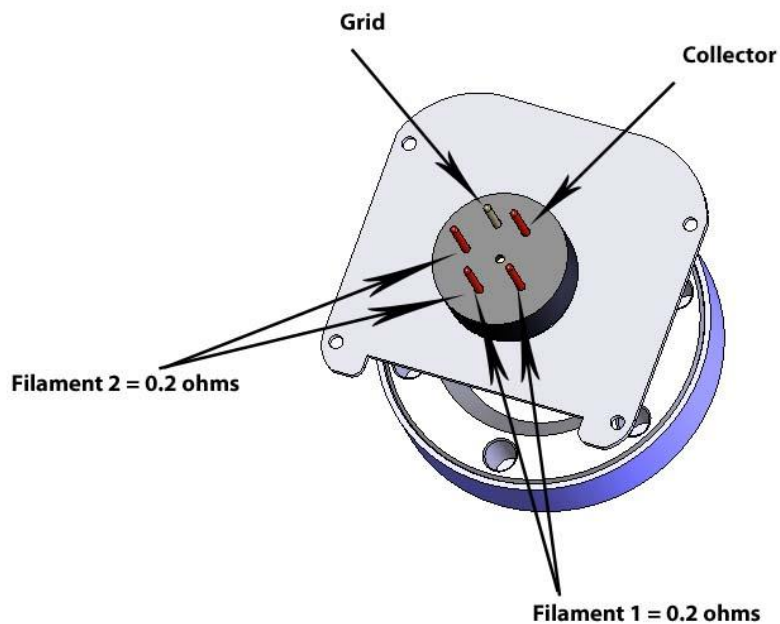

9.5 R & D (Research) Diagnostic Display

In addition to the normal pressure measurement screen the *IGM401* provides a diagnostic display screen that allows you to monitor the measurements of the critical electrical parameters used for measurement of very low pressures, i.e., high vacuum, made by the ionization gauge.

Over time, the hot cathode (filament) of the ionization gauge may degrade. The *IGM401* coated iridium filaments are made using yttrium oxide to lower the work function of the heated wire material and enable substantial emission of electrons from the hot cathode. These electrons are accelerated in an electric field toward the grid structure of the ionization gauge device. The electron emission is commonly referred to as the ‘Emission Current’. As the emission current electrons orbit within the electric field formed by the bias voltages applied to the grid, collector and filament electrodes, the molecules that the gas is comprised of will be ionized by these energetic electrons.

The positive ions that are created within the grid structure are captured in another electric potential field created by the grid structure (at +180 Vdc with respect to ground potential) and the collector wire (at zero volts, i.e., ground potential). In simple terms, the ions collected by the collector electrode (a small diameter wire within the grid electrode structure) are measured with an electrometer circuit connected to the collector. The amount of ion current measured is directly proportional to the density of the gas within the ion gauge transducer. This ion current is commonly referred to as the ‘Collector Current’.

From the collector current measured, which is directly proportional to the gas density inside the ion gauge transducer enclosure, the pressure inside the ion gauge transducer can be calculated.

The R&D display screen is a very useful diagnostic tool to troubleshoot issues with the sensor or the electronics. To access this screen, go to the SETUP DISP menu, select the MODE and then select RESEARCH.

This mode displays the measured pressure, emission current, ion current, filament voltage and filament current. In the following example, the measured pressure is 1.00E-9 Torr, (Pressure unit is based on selected units in SETUP UNIT menu). Emission current is 4.00E-3 amperes, Ion current is 4.00E-11 amperes, filament voltage is 1.5 Vdc and filament current is 1.9 amperes.

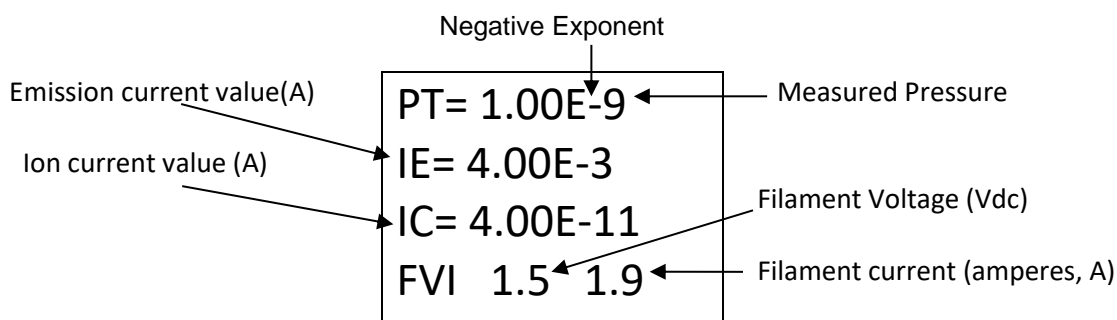

Example - R&D Display of Critical Hot-Cathode Ion Gauge Measurement Parameters

The Pressure, Ion Current (Collector Current) and Emission Current are indications that the ionization gauge transducer is operating and pressure (vacuum) is being measured. In the above example, most of the critical, measured quantities required for the calculation of measured pressure are displayed. The relationship of these parameters leads to the calculation of pressure given by $P = I_C \cdot (I_E \cdot S)^{-1}$ where I_C is the Ion Current, I_E is the Emission Current and S is the sensitivity of the specific ion gauge sensor.

The pressure indication may be checked by using the displayed values and calculating the pressure as indicated by the IGM401.

Other important information such as Filament Voltage and Filament Current are also given in the R&D display screen. These values vary widely dependent upon filament design type, material used for constructing the filament, filament condition and operating emission current. The product of the filament voltage and current is the power dissipation (V•A) required to maintain the set emission current. The interpretation of these displayed values is a qualitative measure. The values will change over time dependent upon the pressure, filament coating condition and possibly even surface properties of the grid electrode. It is a good practice to make note of these values at initial installation and from time-to-time during the operating lifetime of the ion gauge sensor.

A new IGM401 may operate at 100 μ A emission current with only 3 to 4 watts of power required (e.g., 1.5 V @ 2.0 A). By increasing the emission current to 4 mA, the power requirement may increase to 4 or 5 watts (e.g., 2.0 V @ 2 to 2.5 A). Again, the values mentioned here are representative; the actual values you may see for the IGM401 you are using will be different and will vary over time and from device to device. In general, keeping a record of the filament heating power (given by the Filament Voltage and Filament Current readings) will aid you in monitoring the condition of your gauge filaments over time and, perhaps, give you an indication of when to schedule replacement of either the device or the filament assembly.

In cases where the ion gauge sensor does not turn ON or does not stay in the ON condition after you have made sure that the pressure is below the maximum permissible pressure for the emission current setting you have chosen, you will be able to monitor the values displayed in the **R&D** screen and determine if the turn ON / stay ON trouble is related to filament condition. There are maximum operating levels for filament voltage and current; if either of these is exceeded the IGM401 control circuitry will sense the condition and force an OFF condition.

The **R & D (Research) Ion Gauge Diagnostic Display** is intended to assist you in using the information provided in this display as a means to ascertain if the ion gauge transducer is performing as expected under your vacuum chamber operating conditions. There are various causes of trouble that at times may make it difficult to use a single measurement parameter as an indicator of what the problem is. In general, if you have monitored and recorded the values displayed in the R & D (Research) screen over time, you may be able to detect a pattern or trend that, if correlated to a particular failure mode, may prove to be a valuable indication of probable cause.

The values of filament voltage and current presented below are approximate values that one may see in the Research screen. The representative, average values used in this table may vary depending on the condition of the filament and the vacuum chamber environment. For example, you may see a reading of 2.0 V at 100 μ A emission current with a corresponding filament drive current of 2.1 A. This doesn't mean that because the voltage is higher than the value listed (1.7 V) above that there is a problem with the IG. The readings taken should be viewed with the notion that there may be an indication of reaching end-of-useful filament lifetime if the power required to sustain emission current continues to increase over time.

Indication	Possible Cause	Possible Solution
Filament voltage values are present for several seconds immediately after turning IG ON, but then the values are zero	Filament is contaminated or filament has reached end-of-useful operating life for required emission current setting	Switch emission current setting from initial setting and re-start the IG; make several attempts to establish emission current at both 100 μ A and 4 mA. Switch to second filament or replace ion gauge sensor
All parameters in the R&D screen are zero after IG turn ON is attempted	Failed electronics	Replace the IGM401 electronics
IGM401 filament voltage is greater than 1.7 V and filament current is greater than 2.5 A with emission current = 100 μ A	Filament nearing end-of-useful-operating-life	Switch to second filament or replace ion gauge sensor
IGM401 filament voltage is greater than 2.3 V and filament current is greater than 2.7 A with emission current = 4 mA	Filament nearing end-of-useful-operating-life	IGM401 may be operated at either 100 μ A or 4 mA emission current setting. If trouble with maintaining 4 mA emission current (I_e) persists, switch to 100 μ A emission current.

9.6 Maintenance

In general, maintenance is not required for your InstruTech module. Periodic performance checks may be done by comparing the gauge to a known reference standard. When using the transducer in gases containing contaminants or materials that react with the filaments of the hot cathode ion gauge, periodic degas and switching to the alternate filament from time-to-time is recommended for longest useable transducer lifetime. When the hot cathode (filament) of the ionization gauge transducer is at or near end-of-life, transducer (sensor) replacement is recommended.

9.7 Contamination

The most common cause of all vacuum gauge failures is contamination of the sensor. Noisy or erratic readings, and total gauge failure are all possible indications of gauge contamination.

Contamination can be generally characterized as either a reaction of process gases with sensor elements, or an accumulation of material on the sensor elements. Sensors that fail due to chemical reaction are generally not repairable. Sensors that fail due to condensation, coatings, or particles may possibly be restored by performing the degas function.

A) Reactive Gases

If process gases react with the materials of construction of the sensor, the result is corrosion and disintegration of the sensor over time. For general vacuum applications, dual yttria coated filaments are offered for use with air and inert gases such as N₂, argon, etc. Optional dual tungsten filaments are available for use with gases not compatible with yttria coated filaments.

B) Oil, Condensation, Coatings, and Particles

If the failure is due to an accumulation of material in the gauge, you may be able to rid the gauge sensor of adsorbed gas using the degas function of the device.

Oils and hydrocarbons: Exposure of the gauge internal surfaces to oils and hydrocarbons can result in sensor contamination. Some of these types of contamination may be removed by degas. Furthermore, if there is the possibility of oil back streaming from wet vacuum pumps, it is recommended that a filter or trap be installed to prevent contamination of components of your vacuum system.

In some vacuum processes, desorbed and sputtered materials from the process may enter vacuum components connected to the process vacuum chamber by line-of-sight transport especially under high vacuum conditions, i.e., in the molecular flow regime. To prevent materials that may be transported via line-of-sight momentum from entering your vacuum gauge or other components, it is advisable to install some form of apparatus that will block the line-of-sight. In some cases a simple 90° elbow may help prevent or reduce the transport of particles from entering your vacuum gauge.

In the event of gauge contamination you can attempt to degas the sensor. If degas fails to resolve the issue, switch to second filament or replace the sensor as described in the next section.

9.8 Sensor Replacement

The IGM401 ion gauge module is factory calibrated for the specific ion gauge transducer (sensor) installed in it. If both filaments fail for any reason, the sensor can be replaced with a new one. The sensitivity of the new sensor must be re-programmed in the module electronics. Follow all instructions below in order to replace the sensor in the field. If you prefer, you can contact the factory for return authorization and the replacement of the sensor will be done at the factory.

To replace the sensor use the following procedure:

1. Turn off power to the IGM401.
2. Disconnect the cable from the IGM401.
3. Remove the IGM401 from the vacuum system.
4. Use a 3/32 in. size Hex key to remove the #4-40 socket head cap screws (SHCS) as shown below.
5. Detach the metal enclosure and the electronics from the sensor. Gently pull the electronics enclosure away from the sensor using a gentle rocking motion.
6. Replace sensor. Reinstall the screws (4 ea.)
7. Reprogram new sensor sensitivity. The sensitivity is a value designated by the letter "S" and marked on the sensor End Plate.

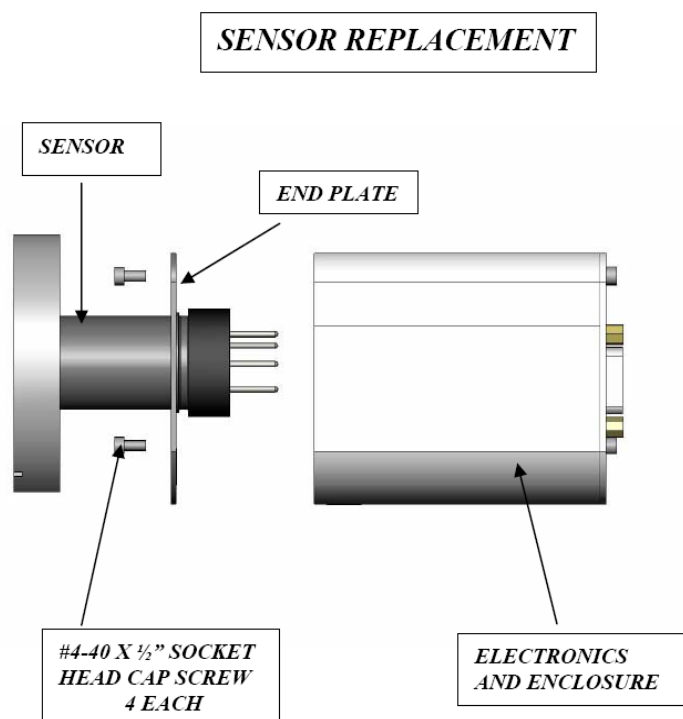

10 Factory Service and Support

If you need help setting up, operating, troubleshooting, or obtaining a return materials authorization number (RMA number) to return the module for diagnosis, please contact us during normal business hours (8:00am to 5:00pm Mountain time) Monday through Friday, at 303-651-0551. Or e-mail us at support@instrutechinc.com.

For the safety of our employees, you must download a material disclosure form from our website at www.instrutechinc.com. Please use this form to provide a history of the gauge detailing what gases have been used. We cannot work on gauges that have been exposed to hazardous materials.

11 Warranty

SELLER warrants that its products are free of defects in workmanship and material and fit for the uses set forth in SELLER's catalog or product specifications, under the normal use and service for which they are intended.

The entire warranty obligation of SELLER is for the repair or replacement, at SELLER's option, of products or parts (examination of which shall disclose to SELLER's satisfaction that it is defective) returned, to SELLER's plant, properly identified within eighteen (18) months after the date of shipment from InstruTech Plant. BUYER must obtain the approval of SELLER and a return authorization number prior to shipment.

Alteration or removal of serial numbers or other identification marks renders this warranty void. The warranty does not apply to products or components which have been abused, altered, operated outside of the environmental specifications of the product, improperly handled or installed, or units which have not been operated in accordance with SELLER's instructions. Furthermore the warranty does not apply to products that have been contaminated, or when the product or part is damaged during the warranty period due to causes other than ordinary wear and tear to the product including, but not limited to, accidents, transportation, neglect, misuse, use of the product for any purpose other than that for which it was designed.

THIS WARRANTY IS EXCLUSIVE AND IN LIEU OF ALL OTHER WARRANTIES, EXPRESS OR IMPLIED, INCLUDING ANY IMPLIED WARRANTY OF MERCHANTABILITY OR FITNESS FOR A PARTICULAR PURPOSE. THIS WARRANTY EXTENDS ONLY IN FAVOR OF THE ORIGINAL BUYER. THE BUYER'S SOLE REMEDY SHALL BE THE REPAIR OR REPLACEMENT, AS IS EXPRESSLY PROVIDED HEREIN, OF ANY WARRANTED DEFECTIVE PRODUCT OR PART, AND UNDER NO CIRCUMSTANCE SHALL SELLER BE LIABLE TO BUYER OR ANYONE ELSE FOR ANY CONSEQUENTIAL DAMAGES TO PERSONS OR PROPERTY, FOR INCIDENTAL DAMAGES OR LOSS OF TIME, FOR ANTICIPATED OR LOST PROFITS, OR ANY OTHER LOSS INCURRED BY THE BUYER RELATED TO THE PRODUCT COVERED BY THIS WARRANTY. THIS EXCLUSIVE REMEDY SHALL NOT BE DEEMED TO HAVE FAILED OF ITS ESSENTIAL PURPOSE SO LONG AS SELLER IS WILLING AND ABLE TO REPAIR OR REPLACE DEFECTIVE PARTS IN THE PRESCRIBED MANNER. THIS LIMITED WARRANTY MAY NOT BE MODIFIED BY SELLER UNLESS SUCH MODIFICATION OR WAIVER IS IN WRITING, EXECUTED BY AN AUTHORIZED OFFICER OF SELLER.



InstruTech[®]

1475 S. Fordham St.
Longmont, CO 80503
USA

Phone +1-303-651-0551

Fax +1-303-678-1754

E-mail info@instrutechinc.com

www.instrutechinc.com