**FUJIFILM
Dimatix
Materials
Printer**



**FUJIFILM Dimatix Materials Printer
DMP-2800 Series
User Manual**





1.0 About this Manual

Throughout this manual a variety of conventions are used to highlight essential information that is important for the overall safety and understanding of issues in using this product. These include:

1.1 Warnings

WARNING



This symbol identifies information about procedures, practices or conditions that can result in damage to the product, economic loss, personal injury, or death.

(Dieses Symbol kennzeichnet Hinweise zu Handlungsweisen, Methoden oder Zuständen die zu Schäden am Produkt, wirtschaftlichem Verlußt, Personenschäden oder zum Tode führen können.)

1.2 Cautions

CAUTION



This symbol identifies information about practices or circumstances that may lead to damage to the product or other economic loss.

(Dieses Symbol kennzeichnet Hinweise zu Handlungsweisen oder Umstände die zu Schäden am Produkt oder anderen wirtschaftlichen Schäden führen können.)

1.3 ESD Advisory ESD = Electrostatic Sensitive Device (*EGB = elektrostatisch gefährdetes Bauteil*)



This symbol identifies where there may be risk of damage to the product due to Electrostatic Discharge.

(Dieses Symbol kennzeichnet Punkte an denen das Produkt durch elektrostatische Entladung beschädigt werden könnte.)



1.4 Wheelie Bin Symbol



This symbol identifies parts that should be reclaimed as part of the Waste Electrical and Electronic Equipment (WEEE) Directive.

1.5 Important

IMPORTANT

This symbol identifies information that is essential to the understanding and correct use of this product.

(Dieses Symbol kennzeichnet, für das Verständnis und den richtigen Umgang mit dem Gerät, wesentliche Hinweise.)

1.6 Notes

Note: Used for emphasizing additional information that aids in the understanding and use of the product.



2.0 Important Safety Information (Wichtige Sicherheitshinweise)

2.1 Safety (Sicherheit)

WARNING

Only qualified, service-trained personnel who are aware of the hazards involved should perform calibration, maintenance, or repair of the product. Only these qualified personnel should remove the covers from the product.

(Kalibrierungen, Wartungen oder Reparaturen am Produkt sollten nur von qualifiziertem Servicepersonal, das sich den bestehenden Gefahren bewusst ist, vorgenommen werden. Nur qualifiziertes Servicepersonal sollte die Abdeckungen am Produkt entfernen.)

WARNING

For continued protection against fire, replace the line fuses only with fuses of the specified type and rating.

(Ersetzen Sie die Eingangssicherung nur mit Sicherungen des spezifizierten Typs und der spezifizierten Leistung, um einen sicheren Betrieb zu gewährleisten und Bränden vorzubeugen.)

WARNING

Modification or misuse of the product or components can cause harm to the user and will void any warranty.

(Veränderungen oder Missbrauch des Produkts, oder Veränderungen oder Missbrauch von Komponenten können den Benutzer oder Dritte schädigen und führen zum Garantieverlust.)



WARNING



The product must be connected to a protective earth conductor via the three-wire power cable. The power plug shall be inserted only into a grounded outlet. Do not defeat the protective action by using an extension cord without a grounded conductor.

(Das Produkt muß durch den Betrieb mit einem dreiadrigen Stromkabel geerdet werden. Der Stecker darf nur in eine geerdete Steckdose gesteckt werden. Benutzen sie nur dreiadrige Verlängerungskabel mit Erdung.)

WARNING



For Dimatix Materials Printer (DMP-2800) serial numbers less than 2831-0646-XXXX-XXXXXXXXXX: Fluid used in this product must have a fire point greater than 125 °C.

(Beachten sie bei Dimatix Material Druckern (DMP-2800) mit einer Seriennummer kleiner als 2831-0646-XXXX-XXXXXXXXXX: Fluide die in diesem Produkt benutzt werden müssen einen Flammpunkt grösser als 125 °C aufweisen.)

WARNING



Do not overfill the ink cartridge. Its maximum capacity is 1.5 milliliters.

(Überfüllen sie die Druckerpatrone nicht. Das maximale Fassungsvermögen der Druckerpatrone beträgt 1,5 Milliliter.)



WARNING

Do not operate the product in an explosive atmosphere. Do not operate the product in the presence of inflammable gases or fumes. Operation of any electrical instrument in such an environment clearly constitutes a safety hazard.

(Benutzen sie das Gerät nicht in explosiver Atmosphäre. Benutzen sie das Gerät nicht in der Nähe von entflammabaren Gasen oder Dämpfen. Der Einsatz jeglicher elektronischer Geräte in einer solchen Umgebung stellt eine eindeutige Sicherheitsgefährdung dar.)

WARNING

Care must be used when jetting multiple fluids. It may be possible for reactions to occur in the absorbent pads where multiple and or incompatible fluids may come in contact with each other.

(Vorsicht ist beim Umgang und Druck mehrerer verschiedener Flüssigkeiten geboten. Es ist möglich, dass Reaktionen in den Absorberkissen stattfinden, wenn inkompatible Flüssigkeiten miteinander in Kontakt geraten können.)

WARNING

The platen can reach temperatures of 60 °C, which is hot to the touch. It can melt some materials if placed on it while hot, and it can cause volatile materials to evaporate faster if placed on the platen when hot.

(Die Substratplatte kann Temperaturen von bis zu 60 °C erreichen. Dies ist zu heiss, um sie gefahrlos zu berühren. Diese Temperatur kann Materialien zum schmelzen bringen, wenn diese auf die Platte gestellt werden. Ausserdem verdampfen flüchtige Materialien schneller wenn sie auf die heisse Platte gestellt werden.)



WARNING



The cartridge can reach temperatures of 70 °C, which is hot to the touch, and it can cause volatile materials to boil off faster. Care must be taken that the cartridge settings are appropriate when installing a cartridge with volatile fluids.

(Das Cartridge kann Temperaturen von bis zu 70 °C erreichen. Dies ist zu heiss, um es zu berühren. Ausserdem verdampfen flüchtige Materialien schneller wenn sie das heisse Cartridge berühren. Die Cartridge Einstellungen müssen sehr sorgfältig gewählt werden, wenn mit leicht flüchtigen Materialien im Cartridge gearbeitet wird.)

2.2 Important (Wichtig)

IMPORTANT

All moving parts are interlocked to the printer lid. The machine will stop if the lid is lifted during operation.

(Alle beweglichen Teile sind mit der Drucker-Klappe gekoppelt. Die Maschine bleibt stehen wenn die Klappe im Betrieb geöffnet wird.)

IMPORTANT

Replaceable pads capture and hold virtually all ink jetted into them. In many cases this may then be considered “solid waste” rather than “liquid waste.” Please dispose of properly.

(Die austauschbaren Absorberkissen können fast alle Tinten aufnehmen. In vielen Fällen gilt dies eher als „Fester Abfall“ und nicht als „Flüssiger Abfall“, bitte entsorgen sie diesen fachgerecht.)

**IMPORTANT**

This product complies with INSTALLATION CATEGORY II and POLLUTION DEGREE 2 in IEC61010-1. This product is an INDOOR USE product.

(Dieses Produkt erfüllt die Forderungen der „Installation Category II“ und „Pollution Degree 2“ nach IEC61010-1. Dieses Produkt ist ein Produkt für den Gebrauch in trockenen Räumen.)

IMPORTANT

The LEDs within this product are Class 1 in accordance with IEC60825-1, CLASS 1 LED PRODUCT.

(Die LEDs in diesem Produkt entsprechen Class 1 nach IEC60825-1, Class 1 LED Product.)



Do not dispose this product as unsorted municipal waste. Collection of such waste separately for special treatment is necessary.

(Entsorgen sie dieses Produkt nicht als unsortierten Hausmüll. Eine fachgerechte Entsorgung ist nötig.)

Note: This equipment has been tested and complies with the limits for a Class A digital device, pursuant to part 15 of the FCC Rules. These limits are designed to provide reasonable protection against harmful interference when the equipment is operated in a commercial environment. This equipment generates, uses, and can radiate radio frequency energy and, if not installed and used in accordance with the instruction manual, may cause harmful interference to radio communications. Operation of this equipment in a residential area is likely to cause harmful interference in which case the user will be required to correct the interference at one's own expense.

Note: This product complies with the radio interference requirements of the European Union.



FUJIFILM Dimatix Materials Printer

About this Manual	ii
Warnings	ii
Cautions	ii
ESD Advisory ESD = Electrostatic Sensitive Device (EGB = elektrostatisch gefährdetes Bauteil)	ii
Wheelie Bin Symbol	iii
Important	iii
Notes	iii
Important Safety Information (Wichtige Sicherheitshinweise)	iv
Safety (Sicherheit)	iv
Important (Wichtig)	vii

Chapter 1 – Introduction

System Accessories	2
System Requirements	2
System Identification	3

Chapter 2 – Set-Up and Installation

Unpacking	5
DMP	5
PC	7
PC Start up	9
Starting Your DMP	9
Dimatix Drop Manager	9

Chapter 3 – Initial Start-Up Operation

Install Cartridge	11
Select Pattern	14
Load/Unload Substrate	15
Print Set-Up	17



Nozzle Test Pattern	18
---------------------------	----

Chapter 4 – Screen Descriptions

Main Screen	19
File Menu	20
Tools Menu	20
Help menu	21
Cartridge Settings	22
Waveform Tab	23
Cartridge Tab	25
Cleaning Cycles Tab	26
Cleaning Cycle Editor	27
Waveform Editor	30
Individual Segment Controls	31
Overall Waveform Controls	31
Non-Jetting Waveform	32
Jetting Waveform vs. Non-Jetting Waveform	32
Replacing Cleaning Pad	32

Chapter 5 – Pattern Printing

Select Pattern	38
Predefined Standard Patterns	39
Create Your Own Pattern	39
Substrate	40
Pattern Block Array	42
Drop Position Array	43
Draw feature	43
Drop Spacing	46
Bitmap File Printing	47
Substrate Tab	48
Placement	50
Tiling	51
Reference Point	51
Print Preview	54
Cartridge Mounting Angle	57

Chapter 6 – Drop Watcher

Drop Watcher	61
--------------------	----



Jetting Nozzle Box 62
 Calibrate Nozzle View 63
 Cleaning Box 65
 Motion Control Box 65
 Drop Watcher Pad. 66
 Viewing Modes. 66
 Tools Tab 73

Chapter 7 – Fiducial Camera

Features. 81
 Alignment Procedures. 84
 Setting the Print Origin. 85
 Setting the Reference Point. 86
 Tools Menu in the Fiducial Camera Window 87
 Options menu in the Fiducial Camera Window 103

Chapter 8 – Fluid Requirements

Dimatix Model Fluid 105
 Drop Formation. 106
 Performance 107
 Drop Velocity vs. Frequency 108
 Drop Velocity vs. Voltage with different Viscosities. 108
 Voltage vs. Drop Mass 109

Chapter 9 – Waveform Basics

Waveform Editor Window Explanation 112

Chapter 10 – Cartridge

Fluid Module Filling. 118
 Fill Syringe 118
 Assembly 120
 Attach Fluid Module to Jetting Module 120
 Cartridge Maintenance 121
 Cleaning Function Definitions 122
 Failure Modes, Prevention and Recovery. 123



Chapter 11 – Print Quality Troubleshooting

Misdirected Nozzles	125
Corrective actions:.....	127
Non-Jetting Nozzles	127
Corrective actions:.....	128
Non-Matched Velocities	129
Corrective action:	130
Cartridge Alignment & Drop Offset	130
Corrective action:	132
Things to remember	133
System Faults	133
Faults.....	133
System Diagnostics	135
Preventative Maintenance	139
Reference Information.....	140

Chapter 12 – Remote Control

Remote Control.....	141
---------------------	-----

Appendix A – Specifications

System Description	145
Mechanical System	146
Cartridge	146
Control PC and Application Software.....	146
Replaceable Items	147
Options	147

Appendix B – Returning a DMP to Dimatix

Return Authorization	149
DMP-2800 Cleaning Procedures	150
Packing up the DMP	150

Appendix C – Technical Support

Online Tech Support	151
---------------------------	-----

Index	153
--------------------	-----



Introduction

The Dimatix Materials Printer (DMP) is a laboratory and limited production tool that enables researchers, scientists, and engineers to evaluate the use of ink jetting technology for new manufacturing and analytical processes. It is designed to be convenient and easy to use to carry out “proof of concept” and development work using ink jet technology. It does have extensive capabilities to allow increased experimental sophistication to optimize process parameters for the user’s applications as the user gains familiarity with the system.

- Sheet substrate scanning ink jet deposition system with drop observation, spot location, and variable printing resolution
- User-fillable piezo-based jetting cartridges:
 - Fluid module with syringe filling system
 - 16 nozzles at 254 μm spacing
- PC-controlled operation, including visual monitoring of ink jetting and printed pattern inspection



1.0 System Accessories

- Personal Computer (supplied)
 - 2.8 GHz CPU minimum
 - One USB 2.0 ports on computer (shows up as “Standard Enhanced PCI to USB Host Controller” in device manager).
 - 1920 x 1200 screen resolution
 - 2 GB DRAM minimum
 - At least 200 MB free disk space
 - Windows 7 operating system
- Starter Kit – consists of (1) DMC-11610 cartridge, (1) 30 ml bottle of model fluid, (1) fill tip, (1) cleaning pad, (1) drop watcher pad, (1) filter and (1) syringe
- Syringes
- Filters
- Fill tips
- Drop watcher pads
- Cleaning pads
- Substrate location and positioning system (fiducial camera system) – Optional

2.0 System Requirements

- Power: 100-120 / 200-240 VAC 50/60Hz 375W maximum
- Environment: It is recommended that the DMP be used in a reasonably controlled temperature and humidity environment to aid in uniform test results. Atmospheric conditions can affect the materials used in jetting trials.
 - Operating:
 - Temperature range 15 to 40°C
 - Humidity range 5-95% RH, non-condensing



3.0 System Identification

The following diagram shows the major components of the Dimatix Materials Printer.

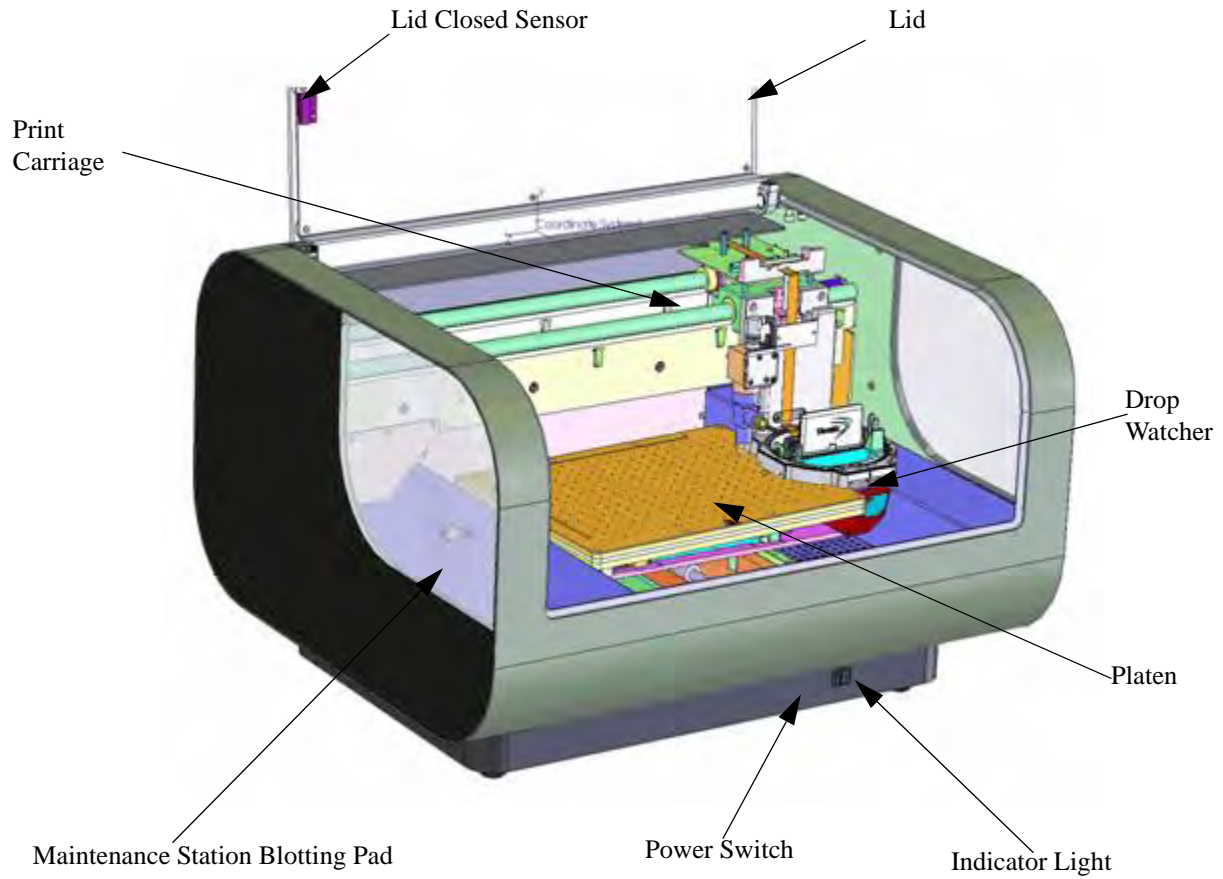

Figure 1 - 1 DMP 2800



The following diagram shows the major components of the DMP Printer Carriage.

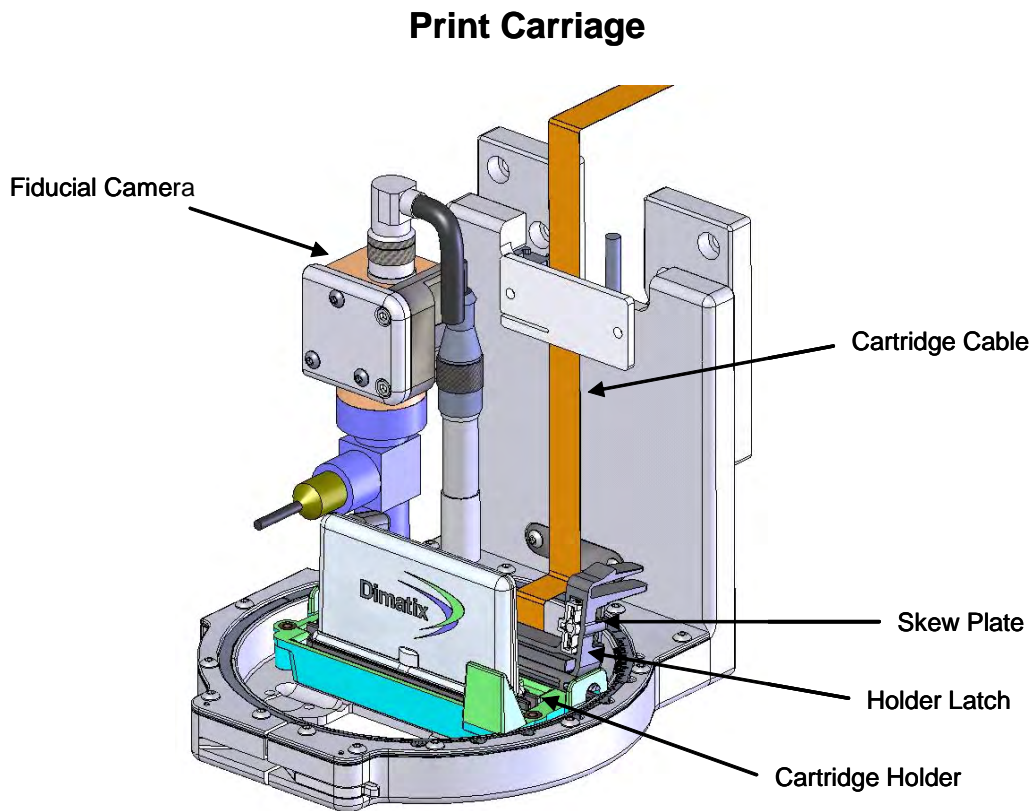

Figure 1 - 2 Print Carriage



Set-Up and Installation

1.0 Unpacking

1.1 DMP

The DMP is shipped in a wooden crate and weighs approximately 45 kg (100 lbs). At a minimum two people are required to lift it out of the crate and place it onto a surface sturdy enough to support it without excessive vibrations or oscillations. *Be careful not to put fingers into fan covers on the DMP bottom when lifting.*

1. Remove the following items from the box:

- Starter Kit
- Cartridges
- User Manual
- Cables



Figure 2 - 1 DMP items in box

2. Verify contents with checklist
3. Place DMP on an appropriate surface.



Note: Consider the air flow pattern for proper ventilation.

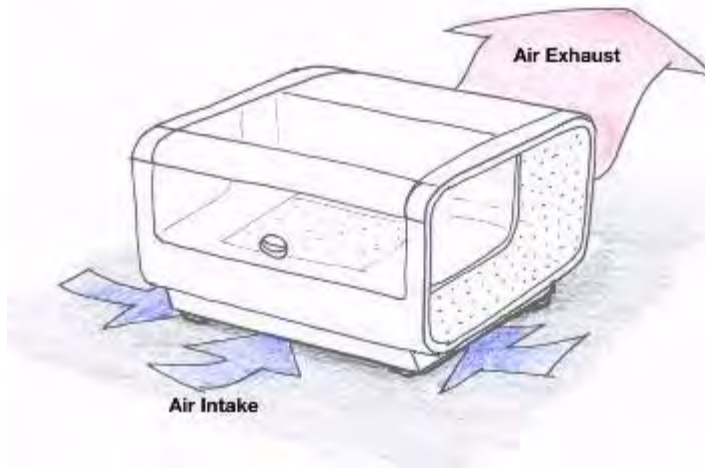

Figure 2 - 2 DMP air flow

4. Remove shrink wrap from DMP
5. Free items that have been secured for shipping

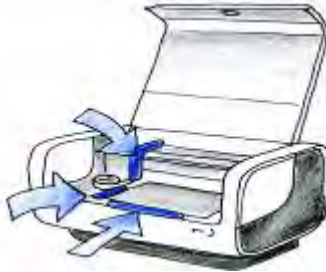

Figure 2 - 3 DMP Packing material locations

- a. Remove packing material from under carriage assembly
- b. Remove packing material from front and side of platen



1.2 PC

The PC system is shipped in its original boxes.

1. Remove them from their boxes and set them next to the DMP

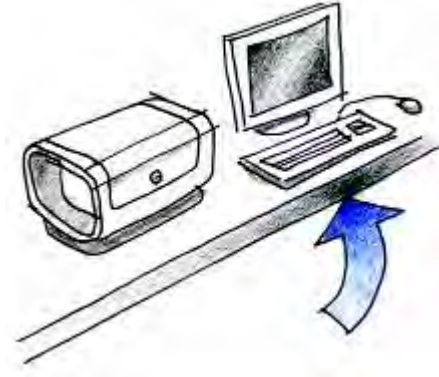

Figure 2 - 4 PC placed next to DMP

2. Check back of the DMP for USB, S-video, and power connections. Identify appropriate cables.



3. Connect all cables
 - a. Power cables to DMP, PC and monitor.
 - b. USB cable from PC to DMP.

CAUTION

Do not connect DMP to PC through a USB hub.
Do not use USB cables longer than 2 meters.



-
- c. S-video cable from DMP to PC.
 - d. Monitor video cable to PC.

CAUTION

Do not use video cables longer than 2 meters.



-
- e. Keyboard and mouse cables.

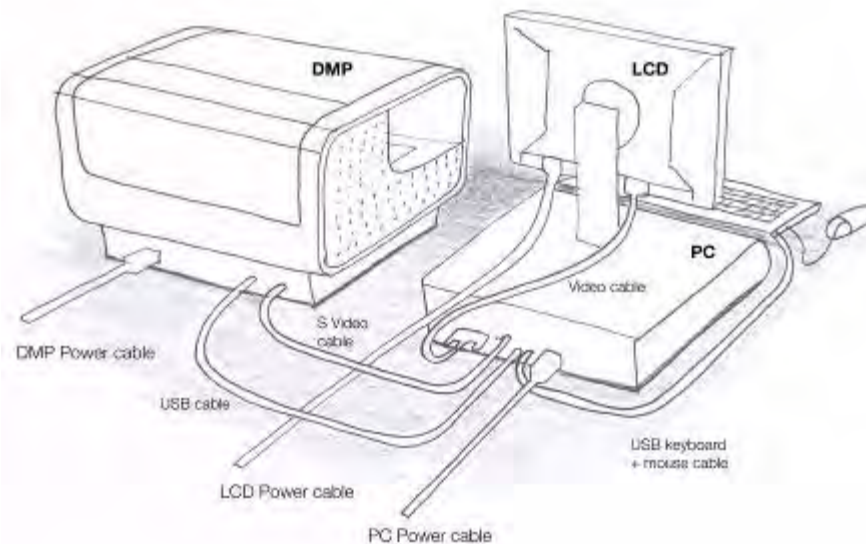

Figure 2 - 5 DMP and PC cabling



2.0 PC Start up

1. Turn on power to PC
2. Allow PC to go through complete start up

CAUTION

Do not change the country settings or the regional settings in the Windows 7 Operating System. The software will not operate properly.

3.0 Starting Your DMP

1. Make sure DMP lid is closed and all shipping foam is removed
2. Turn on power to DMP
 - a. The light next to the power switch should go on.



Figure 2 - 6 DMP Indicator light

- b. Wait at least 5 seconds

4.0 Dimatix Drop Manager

1. The **DMP 2800** icon is on the PC desktop.
2. Select the **DMP 2800** icon on the screen.



Dimatix Drop Manager

Figure 2 - 7 Drop Manager icon on PC screen



3. Double click to initiate the Dimatix Drop Manager application.
4. After initiating the program, click **OK** to allow the DMP to run through its initialization sequence.

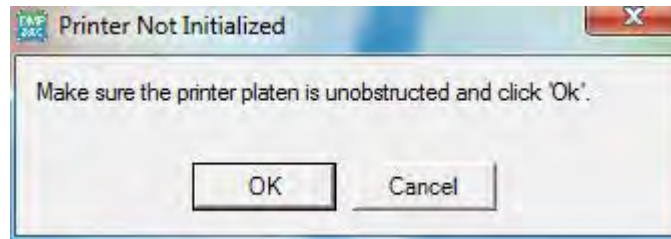

Figure 2 - 8 Unobstructed platen dialogue



Initial Start-Up Operation

1.0 Install Cartridge

The following steps tell you how to install the Dimatix Model Fluid Cartridge.

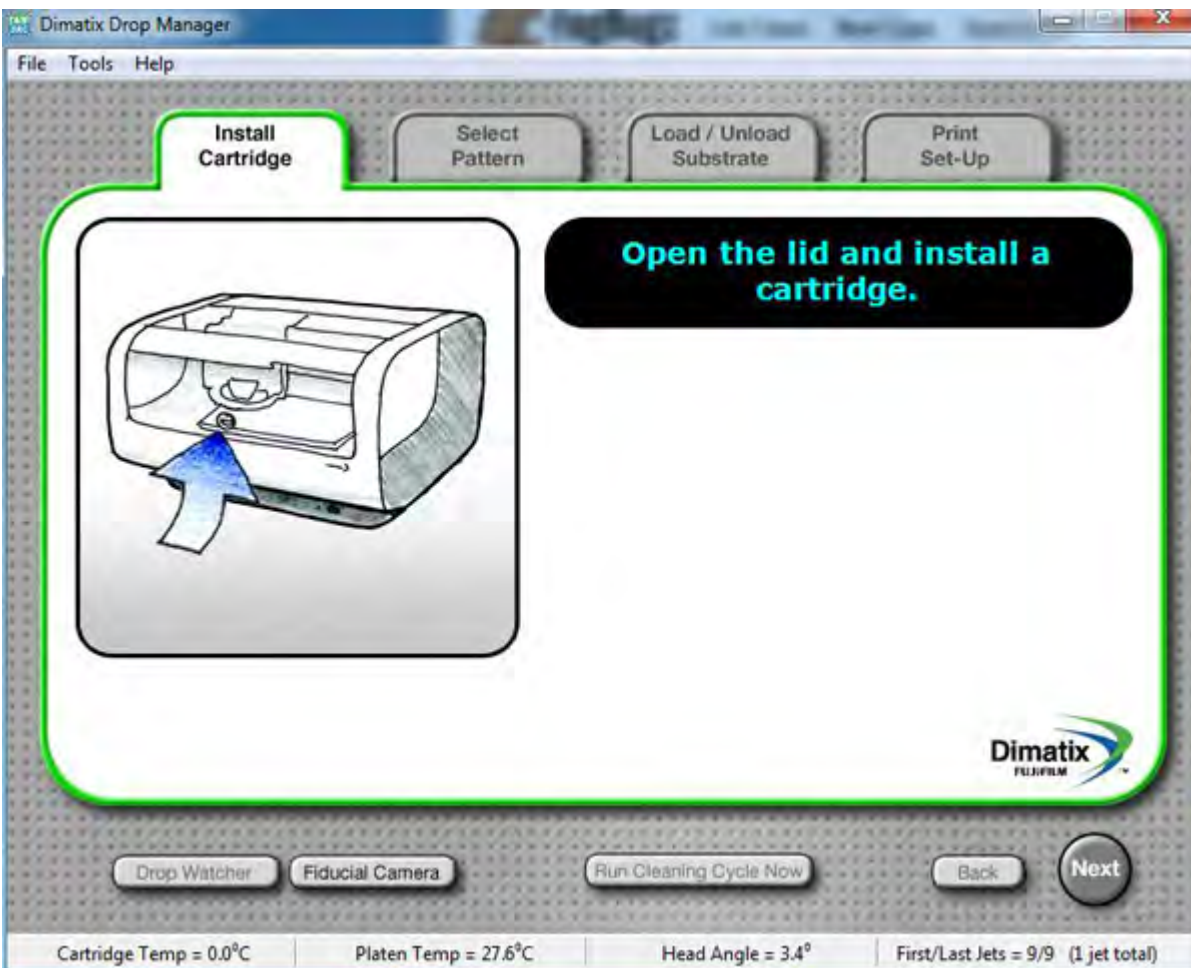

Figure 3 - 1 Install cartridge - Open Lid

1. Prepare the Dimatix Model Fluid **Cartridge** from the Starter Kit. *See Cartridge Filling instructions in Chapter 10.*



2. Lift the DMP lid until it is fully open.

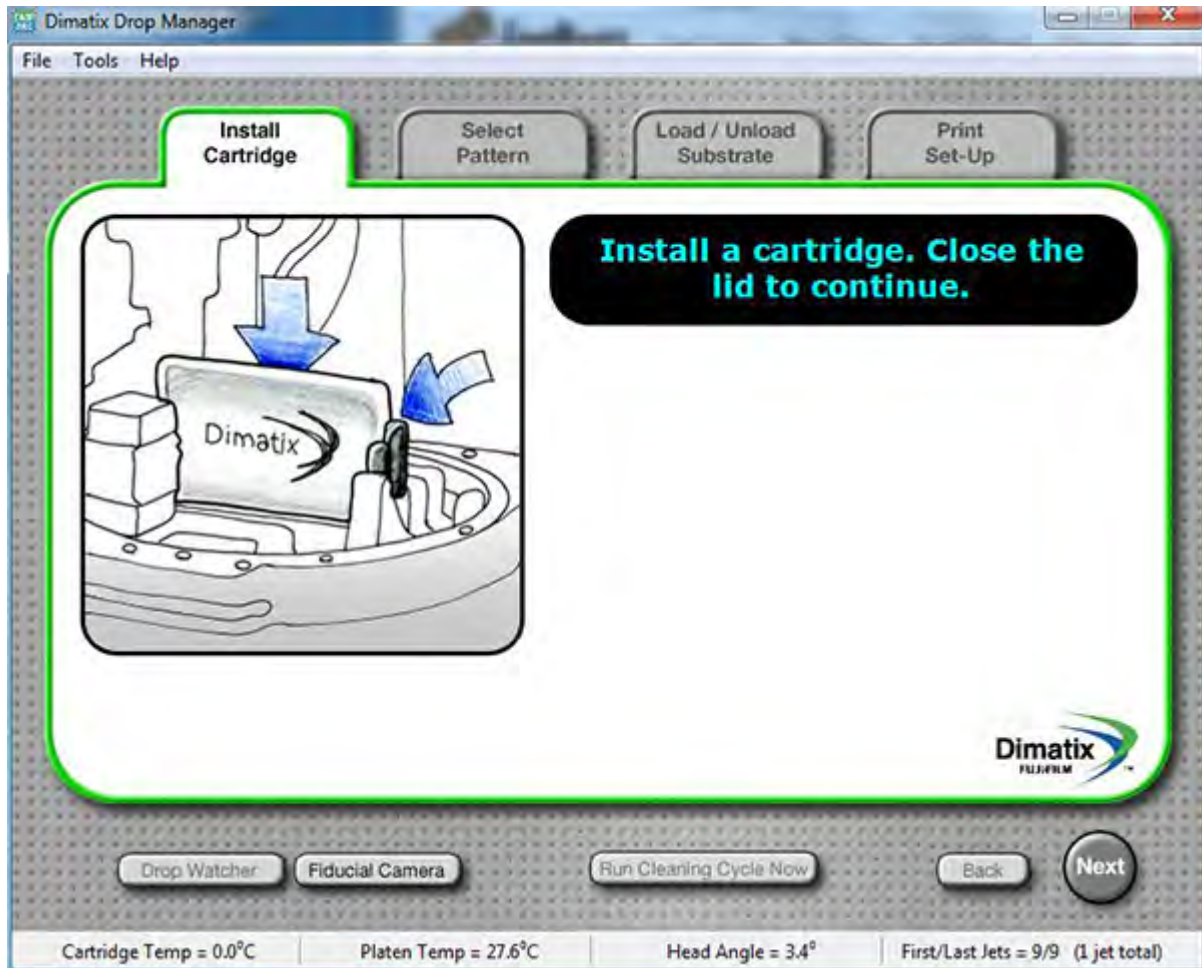

Figure 3 - 2 Install Cartridge

3. Insert the cartridge into the cartridge holder on the carriage with the electrical connection pads towards the back of the machine matching the connector of the holder. There is only one way for it to fit. Push it down firmly so that it “clicks” into place.
4. Pull the cartridge holder latch forward and down until you hear it click and locks into place. Check to see that the cartridge is sitting flat in the holder.

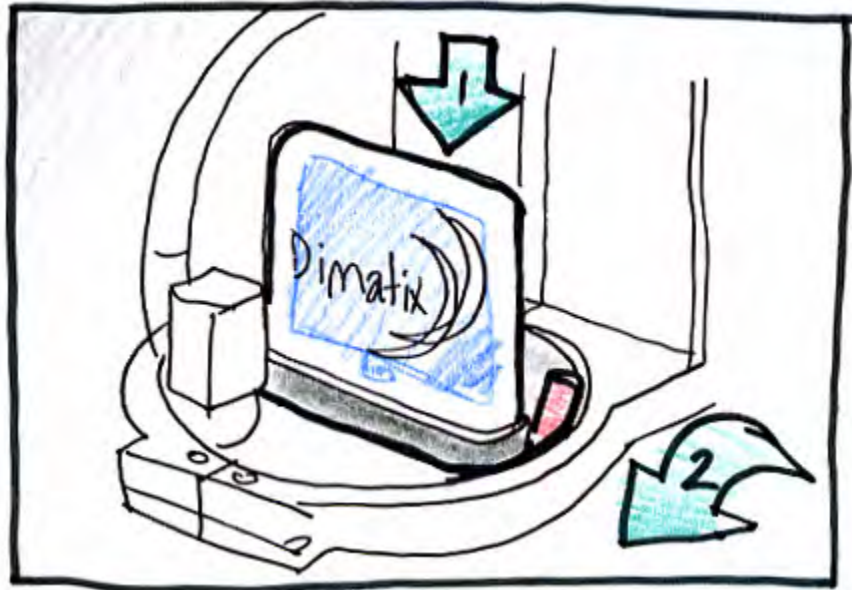

Figure 3 - 3 Installing the cartridge

5. After the cartridge is installed, close the lid. You should hear a pump turn on to control the meniscus pressure.
6. The following window displays.

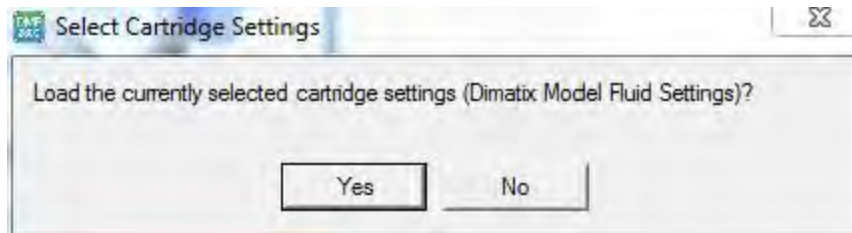

Figure 3 - 4 Confirm load cartridge settings window

7. Click **Yes** to load the settings for Dimatix Model Fluid.
8. After clicking **Yes**, the screen advances to the **Select Pattern Screen**.



2.0 Select Pattern

The **Select Pattern** window lets you select a pattern for printing.

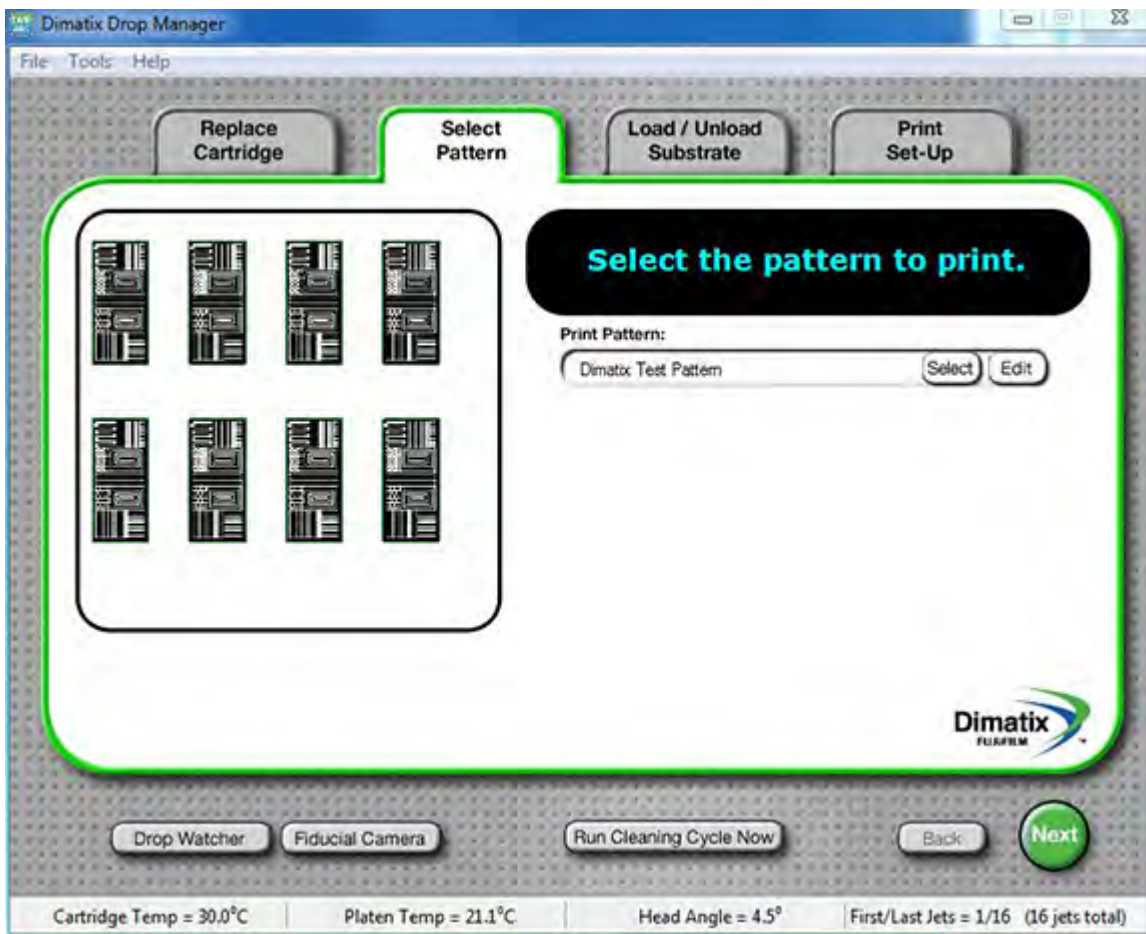

Figure 3 - 5 Select Pattern screen

1. The Dimatix test pattern is auto-selected. This is a general use pattern which lets you see that the system is operating correctly.
2. Click on the **Next** button to proceed.
3. This takes you to the **Load/Unload Substrate** screen.



3.0 Load/Unload Substrate

The **Load/Unload Substrate** tab is where you set the platen temperature and vacuum. It is also where you must enter the thickness for the intended substrate.

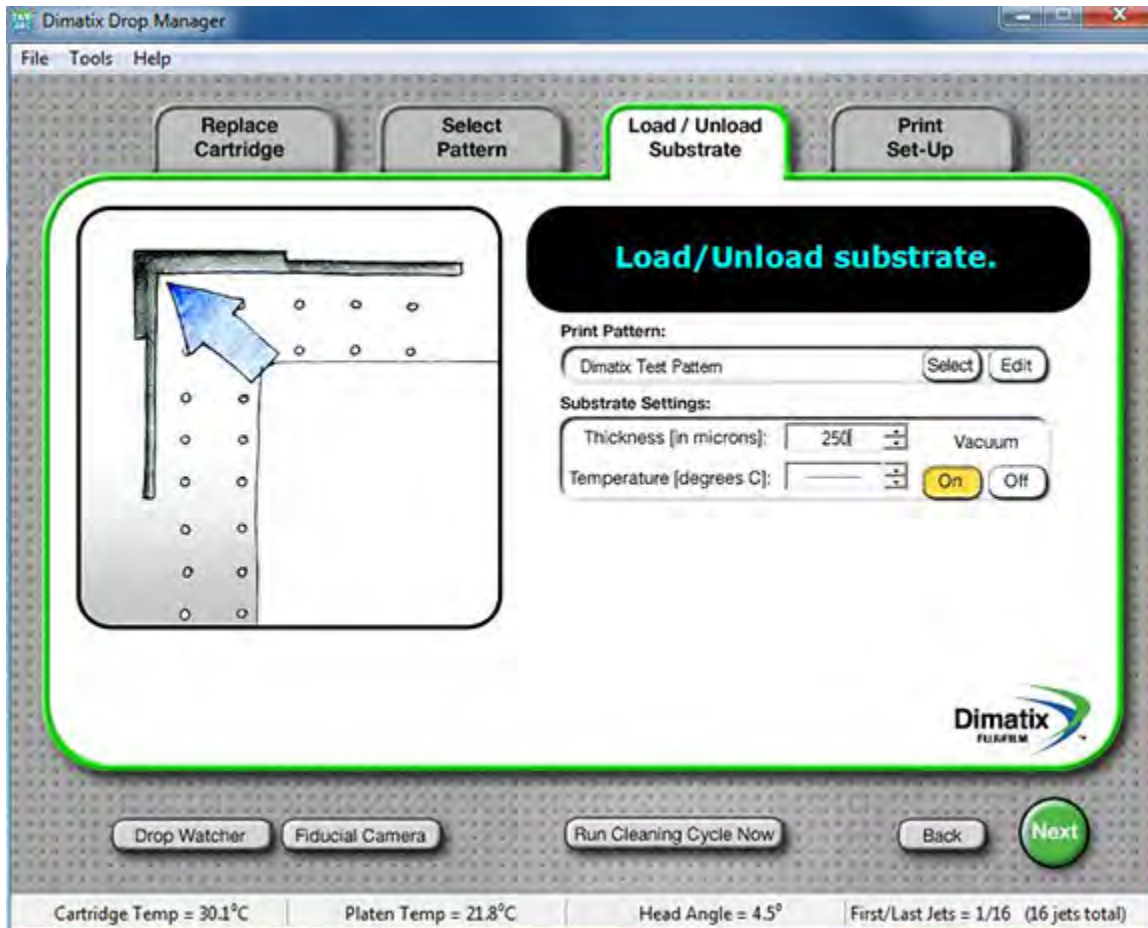

Figure 3 - 6 Load/Unload Substrate screen

1. To start, use the enclosed piece of glossy ink jet paper to run the test pattern. This paper is about 250 micrometers thick. Enter **250** (μm) in the box either by using the up or down arrows on the box or placing the cursor in the box and typing in the number. The system automatically adjusts the height of the cartridge to about 1.0 mm above the substrate.

WARNING



Make sure that you always enter the correct thickness. Entering a number that is smaller than the actual thickness can make the carriage crash into or drag across the substrate causing damage to the substrate and/or the machine.



2. Open the lid and place the substrate on the platen. Register it to the marks in the back left corner of the platen which is a general substrate registration position. This is important to note since it is the approximate location from which the patterns to be jetted are referenced initially.
3. After placing the substrate on the platen, turn on the platen vacuum by selecting the **Vacuum On** button. If your substrate is not very flat, stiff, or smaller than the platen you may need to cover some of the open vacuum holes with mylar, adhesive tape, or other material to direct more vacuum to your substrate.
4. If you want to heat the platen, you can enter the temperature in the box by typing or using the arrows. The system does not print until the platen reaches the desired temperature. This may take up to 20 minutes for a setting of 60°C. To run the platen at ambient temperature, click on the down arrow on the box until you get to a *line* in the box which represents a setting of “no-temperature.”
5. Click on the **Next** button to go to the **Print Set-Up** tab.



4.0 Print Set-Up

The **Print Set-Up** screen summarizes the previously made selections. This screen displays the **Print Pattern**, the **Substrate Settings**, and the **Cartridge Settings**.

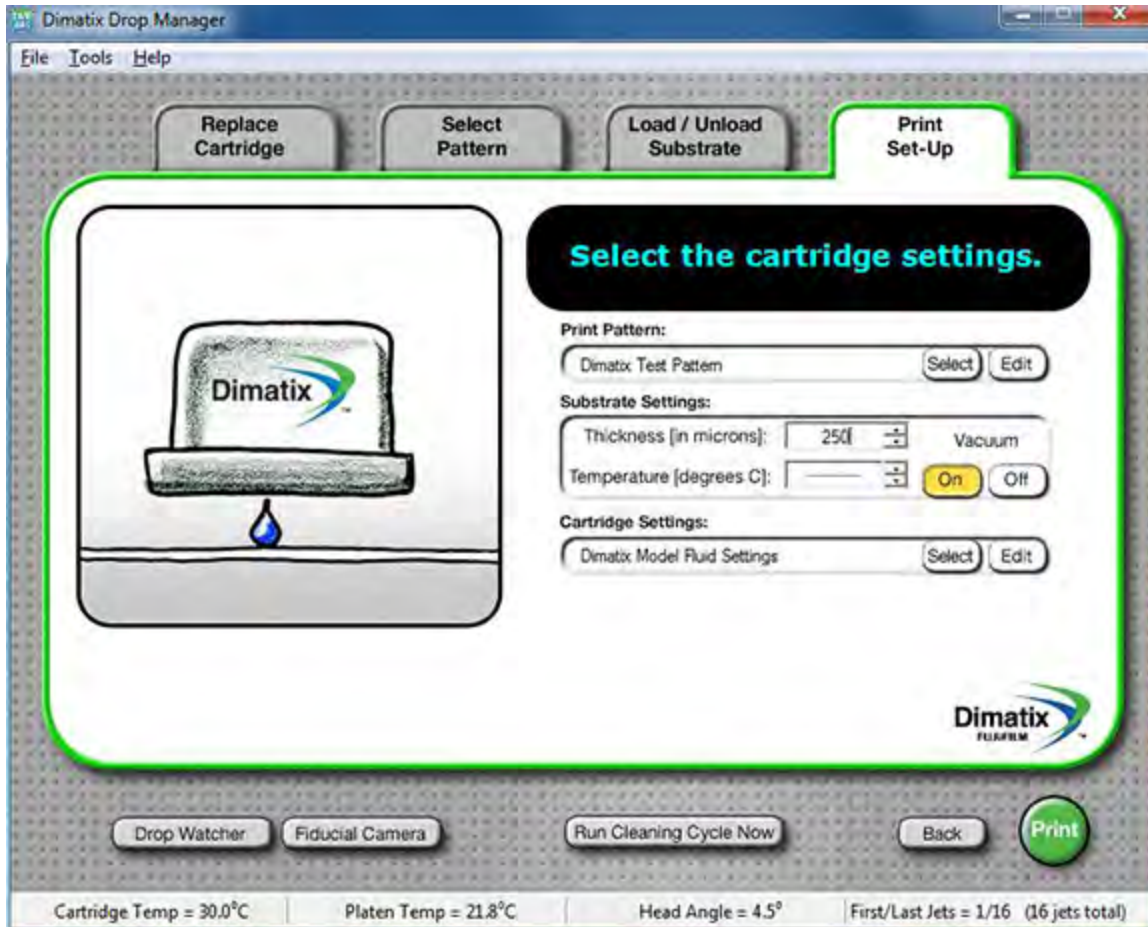

Figure 3 - 7 Print Set-Up screen

Now you are finally ready to start jetting. The pattern has been selected, the Substrate Settings have been entered, and the Cartridge Settings have been entered.



1. Click on the **Print** button and the **Print Preview** window opens. This window shows where the print origin is on the platen, where the image to be printed is and the number of nozzles used to print.

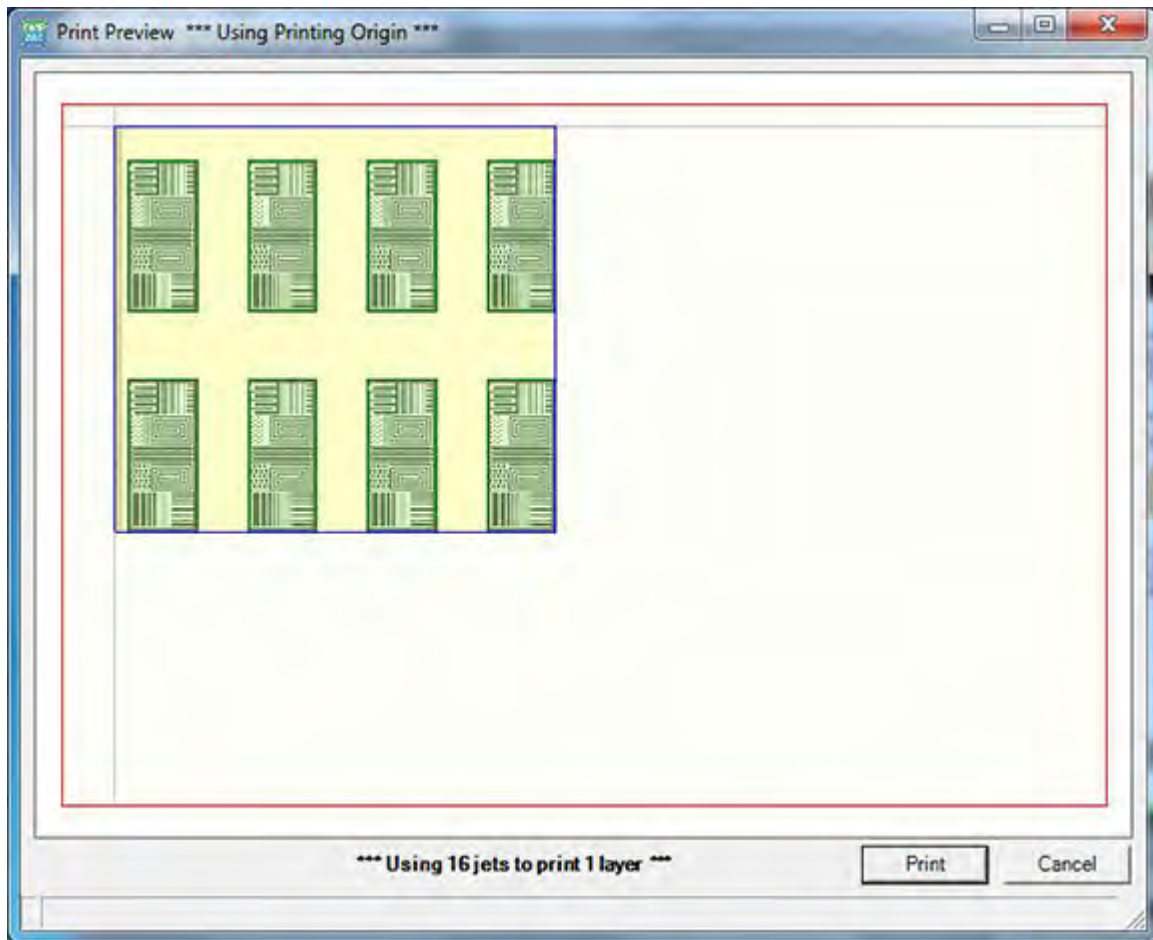

Figure 3 - 8 Print Preview screen

2. Click on the **Print** button to print the pattern. Your DMP jets the test pattern.

4.1 Nozzle Test Pattern

A 16 line test pattern can be run to see the performance of each nozzle individually. This is done from the **Print Set-Up** screen.

1. Set the Cartridge to 90 degrees.
2. Hold down the **Ctrl** key on the keyboard while clicking on the **Print** button at the bottom right of the screen.

You have successfully completed a print sequence.



Screen Descriptions

1.0 Main Screen

The Main Menu screen has three pull-down menus: **File**, **Tools**, and **Help**.

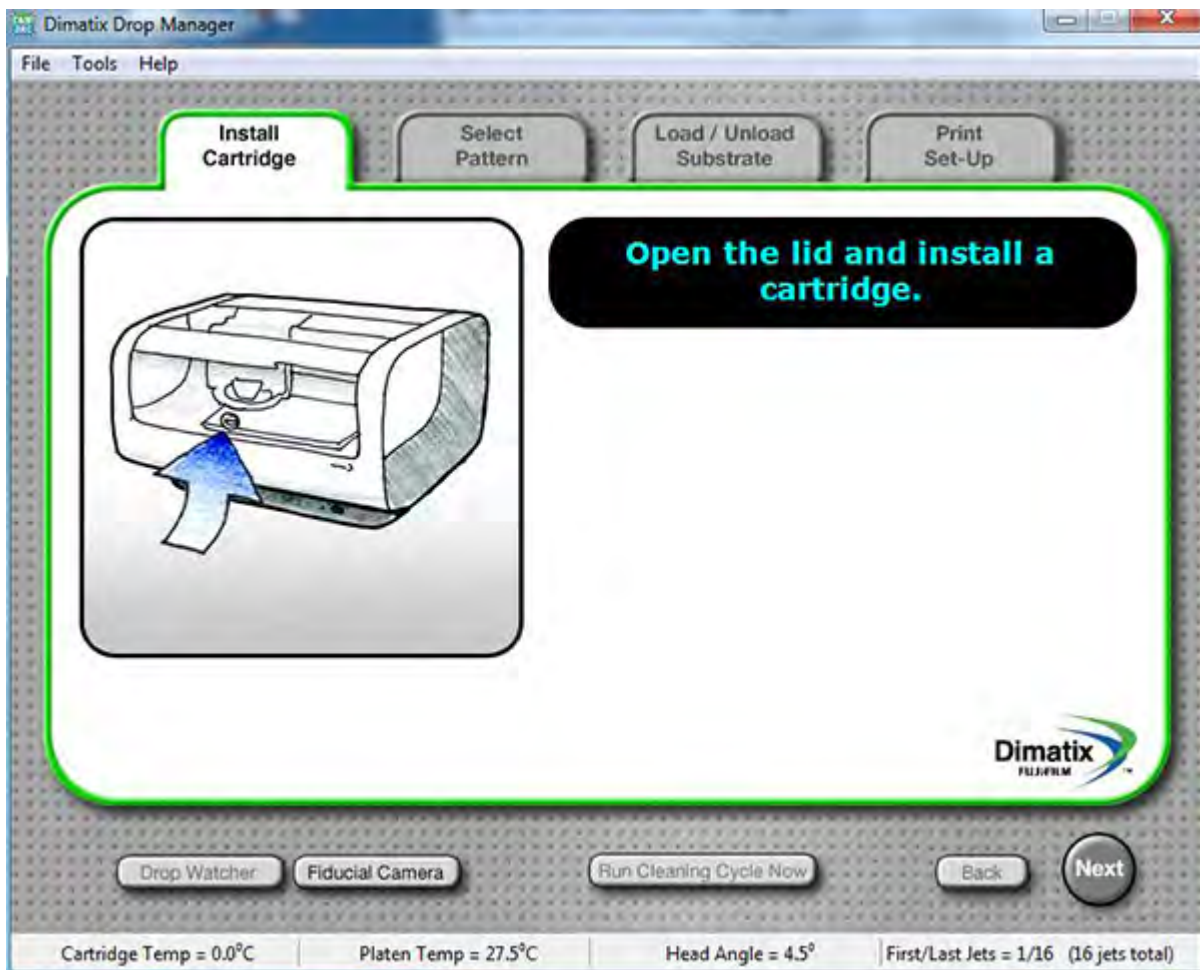

Figure 4 - 1 Main screen



1.1 File Menu

There are two options from the File menu.

- **Printer preview enabled** – this item allows you to turn the **Print Preview** screen on or off prior to starting a print job.
- **Print Info. Logging enabled** – this switch enables the printer to write information about print jobs and the print parameters to a log file in the Print Logs folder. This folder is found in the directory:

C:\Users\Public\Public Documents\DimatixDropManager\PrintLogs

if you did not change the path during software setup.

1.2 Tools Menu

The following options are available from the Tools drop down menu:

- **Cleaning Cycle Editor** – for creating a sequence of operations to save as a cleaning cycle file.
- **Pattern Editor** – allows creation or modification of a drop pattern for printing.
- **Pattern Editor (Bitmap images)** – imports .bmp files into the DMP software.
- **Waveform Editor** – controls the shape of the pulse to the nozzle.
- **Replace Cleaning Pad** – initiates the process for the periodic change of the cleaning pad.
- **Configure UV Lamp** – controls UV lamp settings. The following screen is displayed when you select this option.

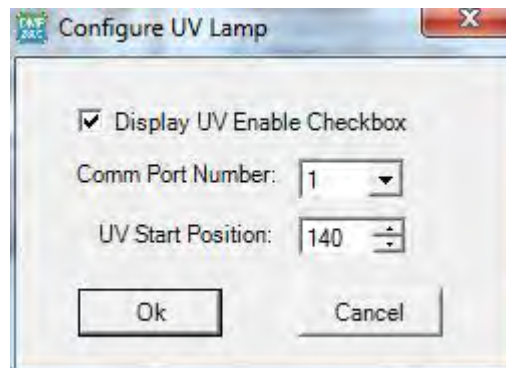

Figure 4 - 2 The Configure UV Lamp screen



- **Display UV Enable Check box** – lets you enable and disable the display of the UV option on the DDM main screen.
- **Comm Port Number** – refers to the communication port that the computer uses to talk to the UV lamp.
- **UV Start Position** – Lets you set an offset value to the position where the lamp turns on during a carriage pass. 140 is the standard value and starts the lamp just at the left corner of the platen. The maximum value is 180.

Note: The UV lamp is optional equipment for the DMP2800. Please contact FUJIFILM Dimatix customer support at cs@dimatix.com for details.

Some of these options are also available from the **Tools** menus of other screens. For further explanations of these options see the appropriate sections of this manual. Consult the Table of Contents or the Index for the appropriate sections.

1.3 Help menu

- **Printer Information** – This option provides information regarding the FPGA and Firmware version on the DMP and its serial number.

Note: The information in the following image is for example purposes only and may not match the information for your DMP.

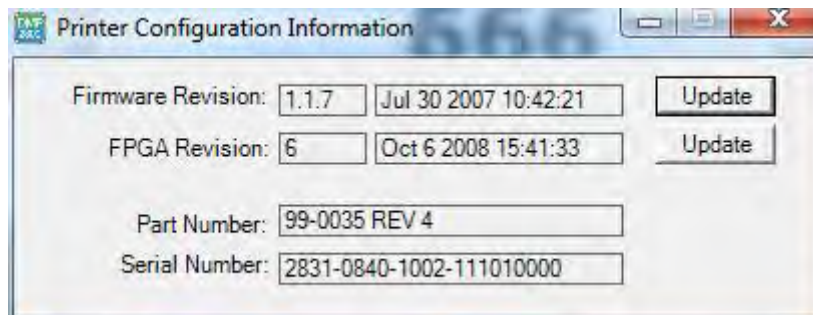

Figure 4 - 3 Printer Configuration screen



- **About** – The following screen provides information about the Dimatix Drop Manager (DDM) software version. To exit press the **OK** button in the lower left.



Figure 4 - 4 DMP About screen

- **Remote Control** – Activate this option in order to enable a remote control session with FUJIFILM Dimatix customer support.

Note: You also need to schedule a remote control session with FUJIFILM Dimatix customer support via telephone =1 (408) 565-7474 or via email cs@dimatix.com for the remote control session to be initiated.
- **System Diagnostics** – This item opens a window that helps you trouble shoot different errors that might occur during operation of the printer, as described in the *System Diagnostic* section later in this manual.

An additional program feature is a link to the FUJIFILM Dimatix Web site. If your PC is connected to the internet, click on the Dimatix logo on the bottom right of the various DDM screens to automatically connect to the web site.



2.0 Cartridge Settings

In the start up procedure we showed you how to select a file with a preset cartridge setting that had been predetermined for the test fluid by FUJIFILM Dimatix. Now we will get into the details of the settings and the editor screens.

Click on the **Edit** button in the **Cartridge Settings** box to display the following screen.

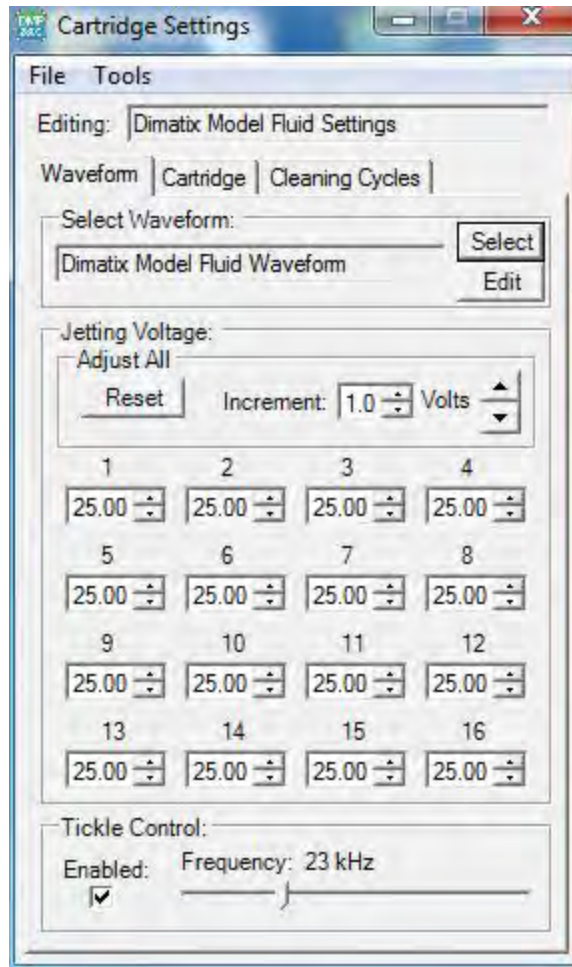

Figure 4 - 5 Cartridge Settings screen

In the above window you can load a previously created cartridge setting file from the **File** menu. You can also save your cartridge setting files.

2.1 Waveform Tab

From the **Waveform** tab the voltage of each nozzle can be individually adjusted by typing a number in the individual nozzle box or by clicking on the up or down arrow in the nozzle box. You may want to do this to adjust drop velocities of individual nozzles, since velocity



is a function of voltage (see Figure 8-5). You can also change all of them simultaneously with the **Adjust All** arrows. (See *Waveform Editor for effects of voltage on jetting*). The **Increment** number is the amount the voltage will change with one click on the up or down arrow buttons. The **Waveform** tab displays the active waveform. You can load previously saved waveforms using the **Select** button or you can edit the active waveform using the **Edit** button.

Note: Once you have established the settings for a particular fluid, you may have to adjust the voltages for a new cartridge to match the drop velocity of a previous cartridge. See **Drop Watcher** for instructions on setting drop velocity.

Note: Tickle Control can only be accessed by opening the cartridge settings of the Print Set-Up screen in the **DDM** main window. Opening the cartridge setting via the **Drop Watcher** does not allow you to change tickle control as it is displayed in gray.

The **Tickle Control** enables and controls the low amplitude pulse that is given to the nozzle periodically simply to move the meniscus slightly but not eject a drop. For certain jetting materials this prevents the nozzle from “skinning over” due to fluid evaporation. The “tickle” function is completely adjustable and, is very important for some fluids and not required for others. Test this function with your fluid before setting it as a default.

The low amplitude pulse that tickle control sends to the nozzle can be modified in the **Waveform Editor** window as the non-jetting waveform. The frequency set in tickle control is always active when the printer is not printing. This includes the times during which the carriage is above the maintenance pad, on its way to the selected print area, or on its way back from one print pass to start the next pass. However, during printing, the tickle frequency is the same as the jetting frequency set with the waveform editor. So during one print job, the printer repeatedly switches between the two pulses.



2.2 Cartridge Tab

If you click on the **Cartridge** tab in the **Cartridge Settings** window, the following screen displays.

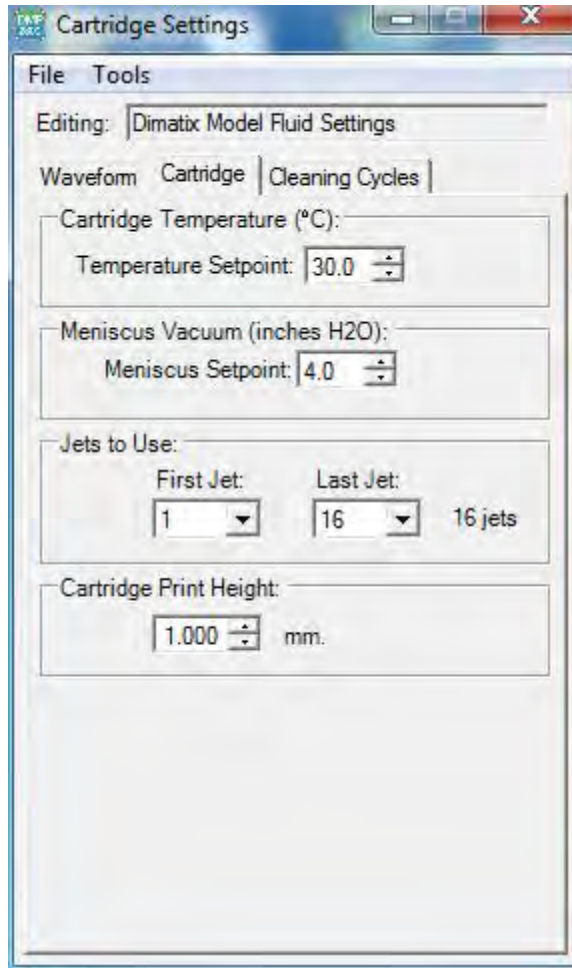

Figure 4 - 6 Cartridge Settings – Cartridge Tab

This screen lets you set the **Cartridge Temperature**. This is usually used when the fluid is too viscous to jet and you need to lower the viscosity by raising the temperature to get the desired jetting performance.

Also on this window is the setting for **Meniscus Vacuum**. Ink jetting devices operate under negative pressure to keep the meniscus at the edge of the nozzle. You may need to adjust this depending on the viscosity and surface tension of your fluid. Four inches of water is a typical value. Having the correct meniscus vacuum level usually affects the high frequency performance of the fluid you are jetting.

The **Jets to Use** function allows you to select the range of nozzles you wish to use to jet your pattern, if you want to use fewer than all sixteen. The software automatically



compensates for the number of nozzles used but the nozzles selected can only be one series of adjacent nozzles.

The **Cartridge Print Height** sets the distance of the printhead above the substrate. It can be adjusted from .250 mm to 1.50 mm.

Note: Take care to set the **Substrate Thickness** and **Cartridge Print Height** accurately to avoid hitting the substrate during printer operation.

2.3 Cleaning Cycles Tab

The **Cleaning Cycles** tab lets you control how the print cartridge is cleaned before, during, and after printing. Some fluids do not need periodic maintenance, while others need a high amount of maintenance to keep nozzles clear and functioning properly.

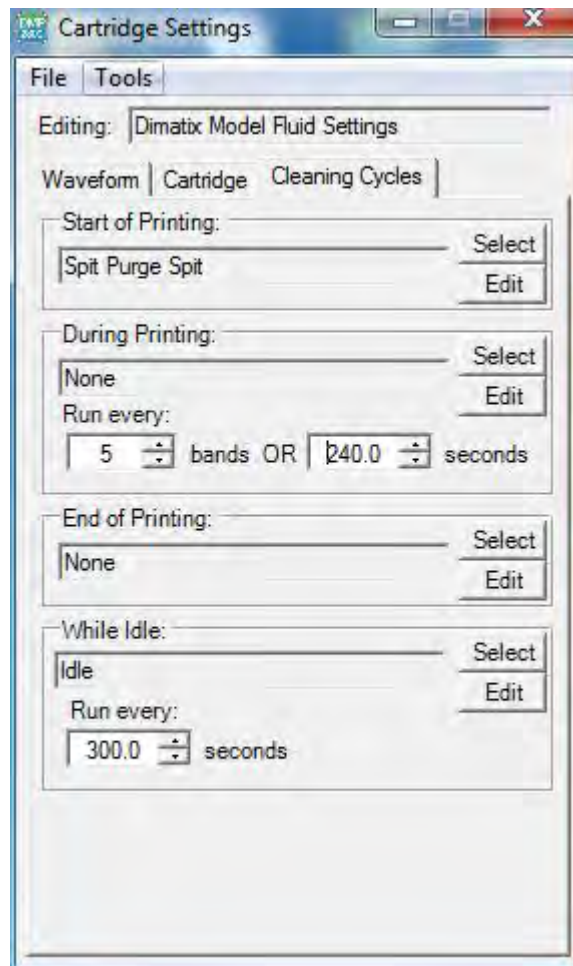

Figure 4 - 7 Cartridge Settings – Cleaning Cycles tab



- **Select** button – lets you select an existing cycle in the cleaning cycle folder.
- **Edit** button – lets you edit that cycle with the editor window.
- **Start of Printing** – refers to the cleaning you want to do at the beginning of the print. Select a cycle you wish to run to enter one in that box or you can edit an existing file with the **Edit** button.
- **During Printing** – refers to the cleaning cycle you want to run while printing your pattern. This can be set to run every so many number of **Bands** (*one cycle of the carriage across the platen and back is a band*) or every so many **Seconds** of printing time. Select a cycle you wish to run by clicking on **Select** and choose one from the folder or you can edit an existing one with the **Edit** button. Whichever is more frequent between **Run every x Bands OR Seconds** (depending on printing speed) is the cycle that is used **During Printing**.
- **End of Printing** – refers to the cleaning you would like to do at the end of your printing. Select a cycle you wish to run to enter one in that box or you can edit with the **Edit** button.
- **While Idle** – refers to any cleaning you would like to do while the system is not printing but is on and you have a cartridge installed. Select a cycle you wish to run to enter one in that box or you can edit with the **Edit** button.
- **None** – is a preexisting empty cleaning cycle that you can use in order for the printer to not do any cleaning during that time.
- **0** – can be entered where numbers are required to indicate not to run that cycle.

3.0 Cleaning Cycle Editor

The **Cleaning Cycle Editor** is run

- by clicking the **Edit** button next to any of the cleaning cycles or
- by selecting **Cleaning Cycle Editor** from the **Tools** menu in the **Cartridge Settings** window or the DDM Main screen or
- by selecting the **Cleaning** group in the **Drop Watcher** window.



From this editor you can create sequences of operations that can be saved as a cleaning cycle file. Refer to the **Cartridge Maintenance** section in the back of the manual for more details. The default cleaning cycle, **Spit Purge Spit**, is shown below.

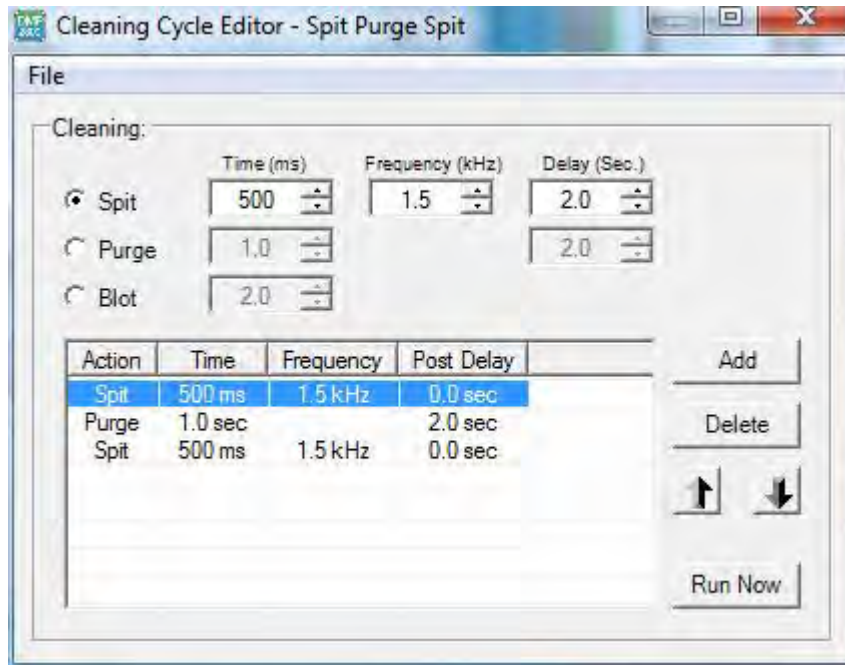

Figure 4 - 8 Cleaning Cycle Editor screen

- **Spit** – refers to jetting the nozzles for the designated time at the given frequency.
- **Purge** – refers to pushing fluid out through the jetting device with pressure (system is preset to 5psi). This process is usually used to get air out of the jetting device.
- **Blot** – refers to the cartridge simply coming down and making contact with the cleaning pad for the designated time. As the nozzle plate is recessed into the cartridge it does not touch the cleaning pad. The cleaning pad gets close enough to absorb fluid residue on the nozzle plate.

Note: It is important to make sure that the cleaning pad is not saturated or clogged to ensure good removal of the fluid from the nozzles after purging or spitting.

- **Delay** time – is the time after the cleaning before going to the next step in the cycle.

A cleaning cycle can be very simple, such as a “2 second blot” or they can consist of several combinations of actions (spitting, purging, and blotting) with varying times.

Here is how to create a cleaning cycle:

1. Click on the **Spit**, **Purge**, or **Blot**.



2. Then enter a number or use the arrows for the **Time**, **Frequency** or **Post Delay** that you want.
3. Click the **Add** button to enter it into the table and incorporate it into the cycle.
4. If you want another action to occur next, simply repeat the process.
5. If you want to delete a step, highlight it in the table by clicking on it, then click the **Delete** button.
6. When you have built your cleaning cycle, **Save** it with a name that describes what it does using the **Save As** from the **File** menu.

If desired you can run the cleaning cycle you just created by clicking on the **Run Now** button in the **DDM** main window.



4.0 Waveform Editor

The waveform editor is where you make changes to the waveform by adding or deleting segments, make changes to the segments, or rescale a waveform.

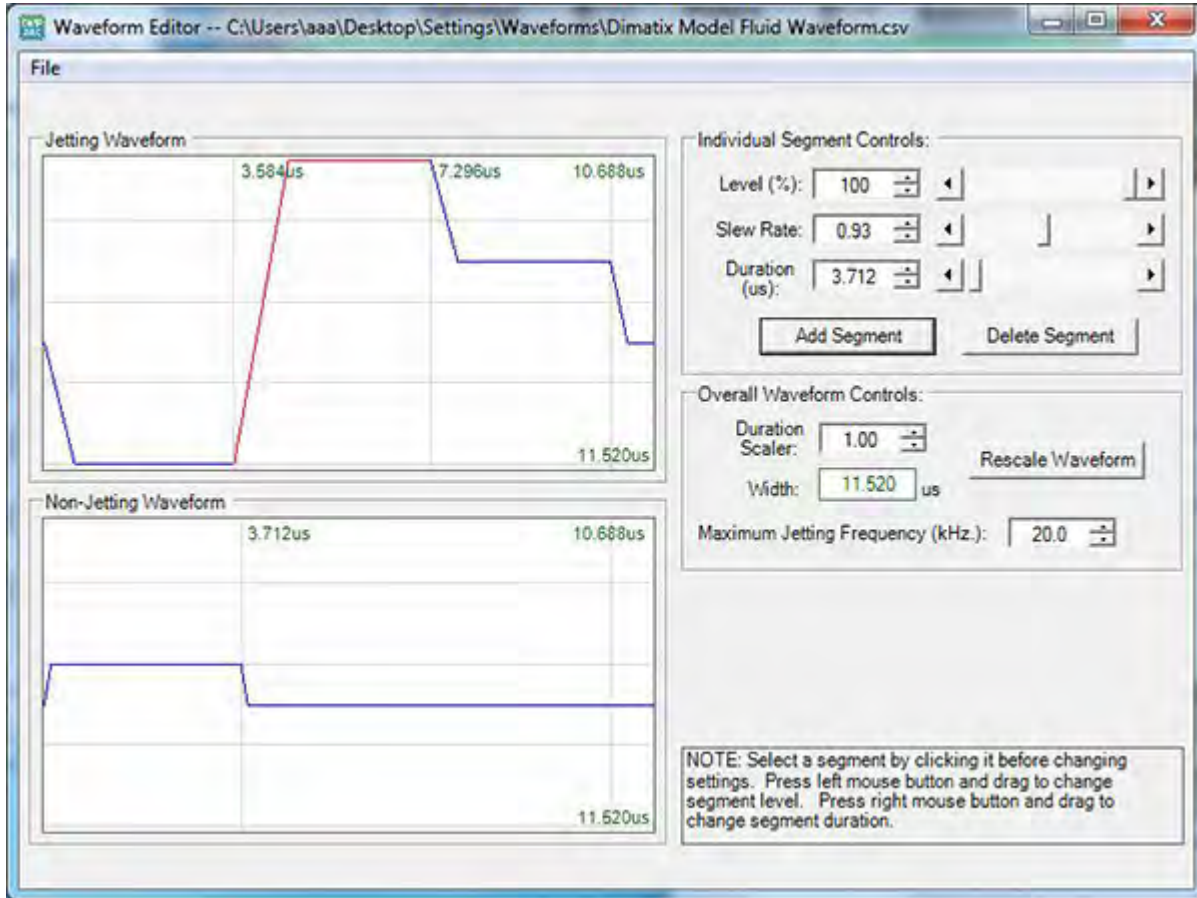

Figure 4 - 9 Waveform Editor screen

This is the control screen for the electrical signal that triggers the drop ejection. This signal is shown in the **Jetting Waveform** section. The signal consists of multiple segments (four in the above example). To adjust a segment, simply point your with your mouse and click on it. The selected segment changes from blue to red.

The *Waveform Basics* chapter, later in this manual, describes how changing the waveform affects drop ejection. There is an application note available through the Tech Support link at the bottom of the FUJIFILM Dimatix home page that elaborates on this topic.



4.1 Individual Segment Controls

In this group you have several parameters at your control. If you want to modify a segment, click on that segment in the graph with the mouse to highlight it. Now modify the parameters for it by typing in a number, using the up/down arrows or slider bar.

Level – This is the percent of the amplitude relative to the value specified in the **Cartridge Settings Waveform** screen.

Slew Rate – This is the slope of the line in the waveform during voltage ramps.

Duration – This is the length (in time) of the segment.

You can add waveform segments to optimize drop ejection. Click on the segment that you want to place a new segment in front of and click the **Add** button. You can now modify that segment as you would the others. You can delete a segment simply by clicking on it and selecting the **Delete** button.

Note: The duration and the level of a segment can also be modified by holding down the mouse button and moving the mouse. Hold down the **left** mouse button and move the mouse up or down to modify the level of a segment. Hold down the **right** mouse button and move the mouse left or right to adjust the duration of a segment. These instructions are in the box to the right of the graph.

4.2 Overall Waveform Controls

Duration Scaler – This feature allows the user to easily scale the entire waveform pulse width at once. This is useful when you are using fluids with different densities. Fluids with higher densities generally need longer pulses. Enter a number in the box then click the **Rescale Waveform** button. The entire waveform's width changes by multiplying its current width by the **Rescale** number. For example, if you enter 1.1 in the **Duration Scaler** box, it adjusts each waveform segment's length proportionally to multiply the waveform's overall width by 1.1, which is a 10% increase.

Width – This box displays the overall pulse time width for the entire waveform.

Maximum Jetting Frequency – The maximum jetting frequency is established by the user during initial fluid characterization using the drop watcher system. During initial characterization the maximum frequency of 80 kHz should be entered into the waveform file being loaded. This value dictates the scale for the **Jetting Frequency Maximum** in the **Drop Watcher** window. After the user has established the maximum sustainable jetting frequency in the drop watcher **it is essential** to ensure the maximum jetting frequency



setting in the waveform file does not exceed the frequency used to optimize jetting in the drop watcher.

CAUTION

If you fail to limit this frequency setting to the maximum frequency used during drop watcher evaluation you can create a situation where the system uses one frequency for drop watching and another for printing. This invalidates the correlations between visual observations in the drop watcher and actual printing performance!

4.3 Non-Jetting Waveform

The **Non-Jetting Waveform** can be modified just like the jetting waveform. The instructions are in the box to the right of the graph.

4.4 Jetting Waveform vs. Non-Jetting Waveform

When the printhead travels over the print area, the software automatically tells it which nozzles to jet and which are idle. The idle nozzles get the amplitude signal displayed in the **Non-Jetting Waveform chart**. The jetting nozzles get addressed with the **Jetting Waveform**.

The **Non-Jetting Waveform** is also the pulse signal that the **Tickle Control** sends to the printhead during non-printing times. Such as when the carriage is above the maintenance pad, or when it is moving to the defined print area or moving between two print passes. Raising the amplitude of the non-jetting waveform above the default zero condition can help some fluids to start-up more reliably.

5.0 Replacing Cleaning Pad

Located in the **Tools** pull down menu on the DDM main screen is a feature called **Replace Cleaning Pad**. You will want to replace the cleaning pad with a new one when it gets filled with fluid or clogged by fluid residue and does not effectively blot the nozzle surface of the cartridge, or you are changing cartridge fluids and don't want cross contamination from contacting the previous material on the cleaning pad.



To replace the cleaning pad select **Replace Cleaning Pad** from the **Tools** menu. The cartridge moves to allow access to the pad.

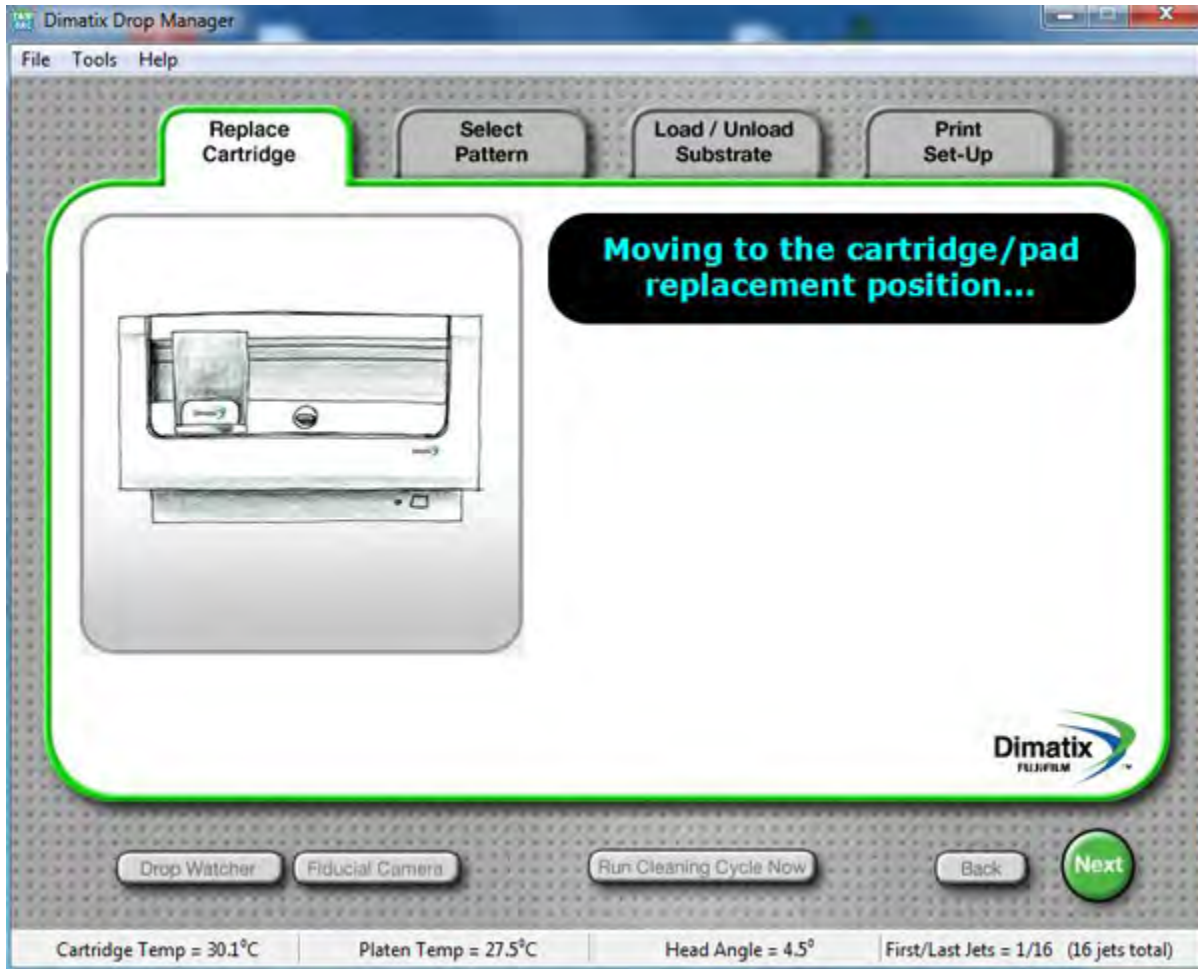

Figure 4 - 10 DDM – Moving the Cartridge screen

DO NOT open the printer lid until told to do so.

IMPORTANT

Opening the lid while the printer is in motion necessitates a re-initialization of the printer.

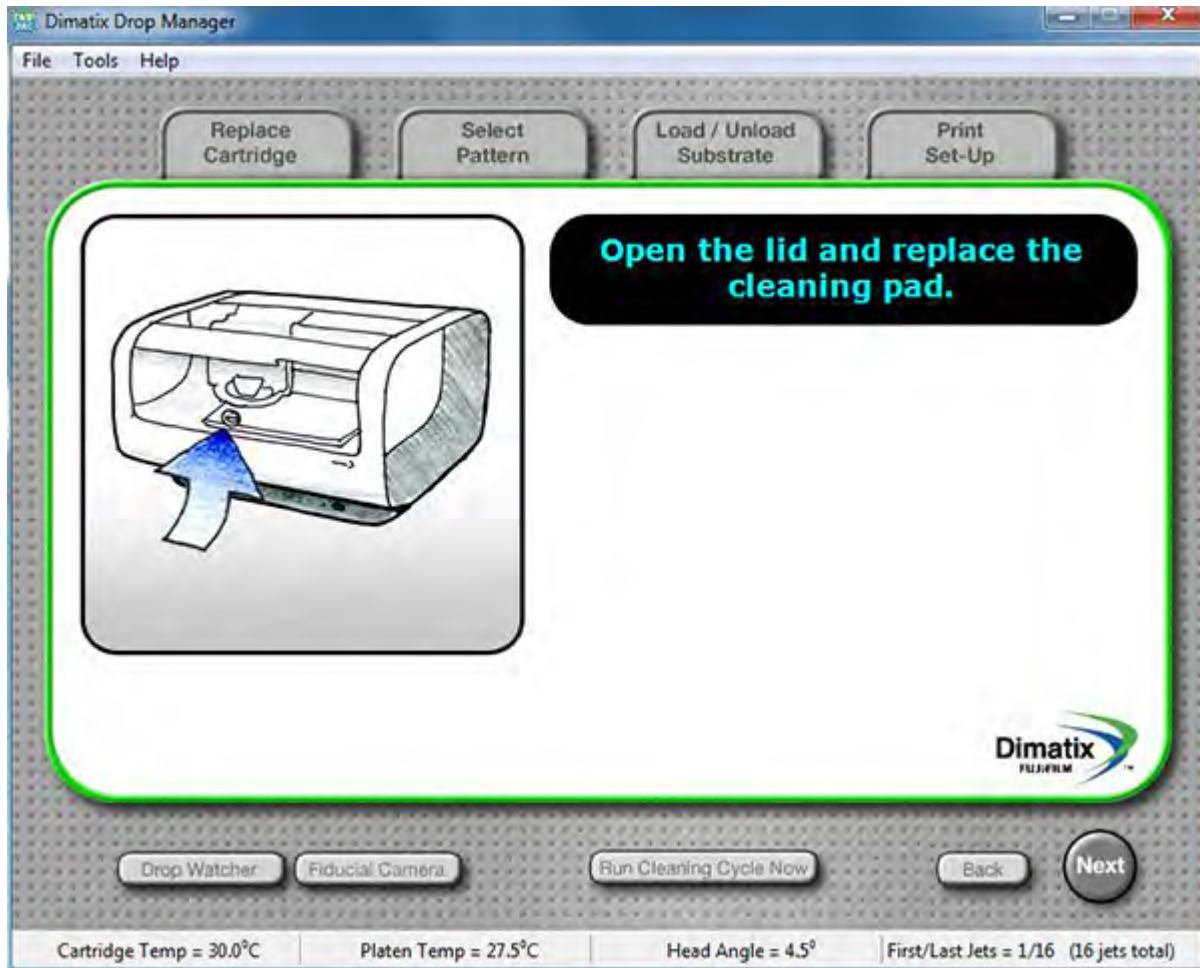

Figure 4 - 11 DDM – Open the lid screen

Open the lid and replace the pad.

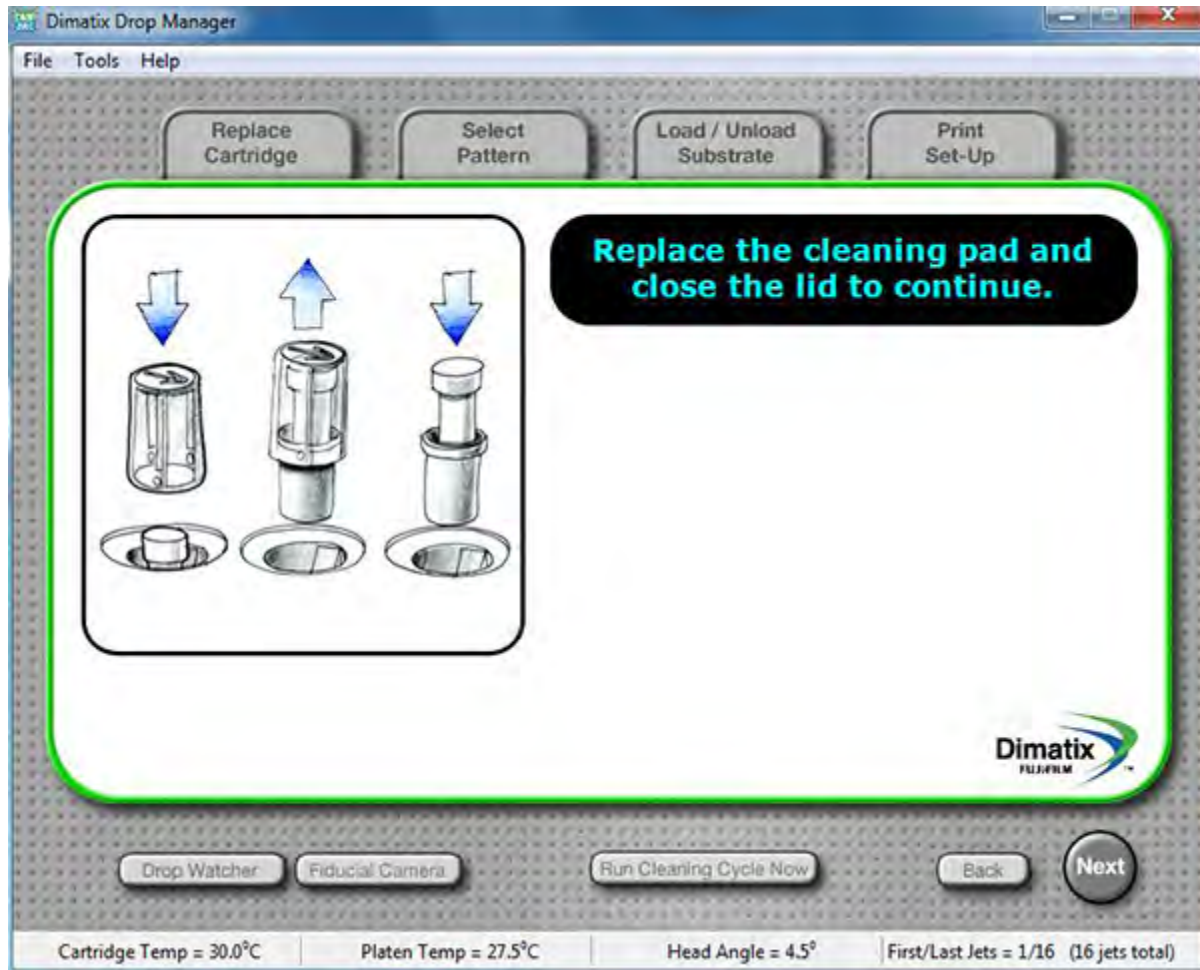

Figure 4 - 12 DDM – replace cleaning pad screen

Replace the pad by:

1. Taking the top clear cap of a new Cleaning Pad assembly and push it down on the old pad until you hear a click and then simply pull it out.



2. Insert the new pad and holder by pushing the pad and holder down into the spot where the old one was until you hear a click.

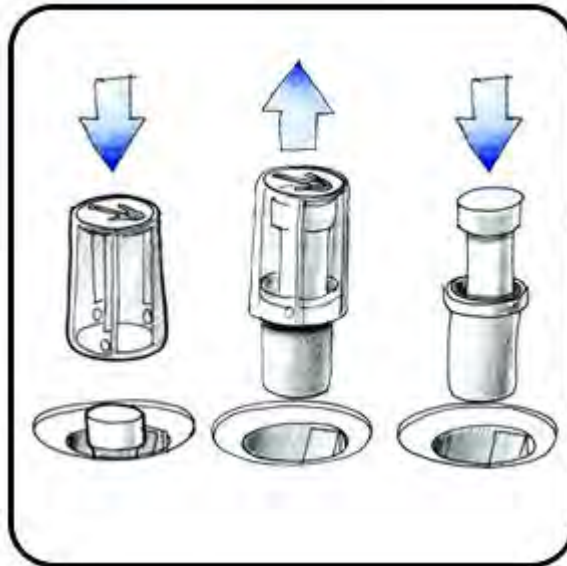
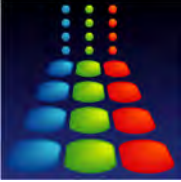

Figure 4 - 13 Cleaning Pad replacement

IMPORTANT

Be careful not to remove the cleaning pad by itself. This can damage the springs holding the receptacle which will then not position it correctly. Do not touch the top of the new maintenance pad with your fingers.

When the lid is closed the carriage moves back to the cleaning station.



Pattern Printing

If you are printing a pattern on a substrate that you will either remove or reposition, or you want to change cartridges in between printing two layers, be sure to set the print origin before printing the first pattern. This is done using the Fiducial Camera. If you change cartridges, you also have to perform a drop offset adjustment.



1.0 Select Pattern

The following screen allows you to pick a print pattern file that has already been created, or to create a new one.

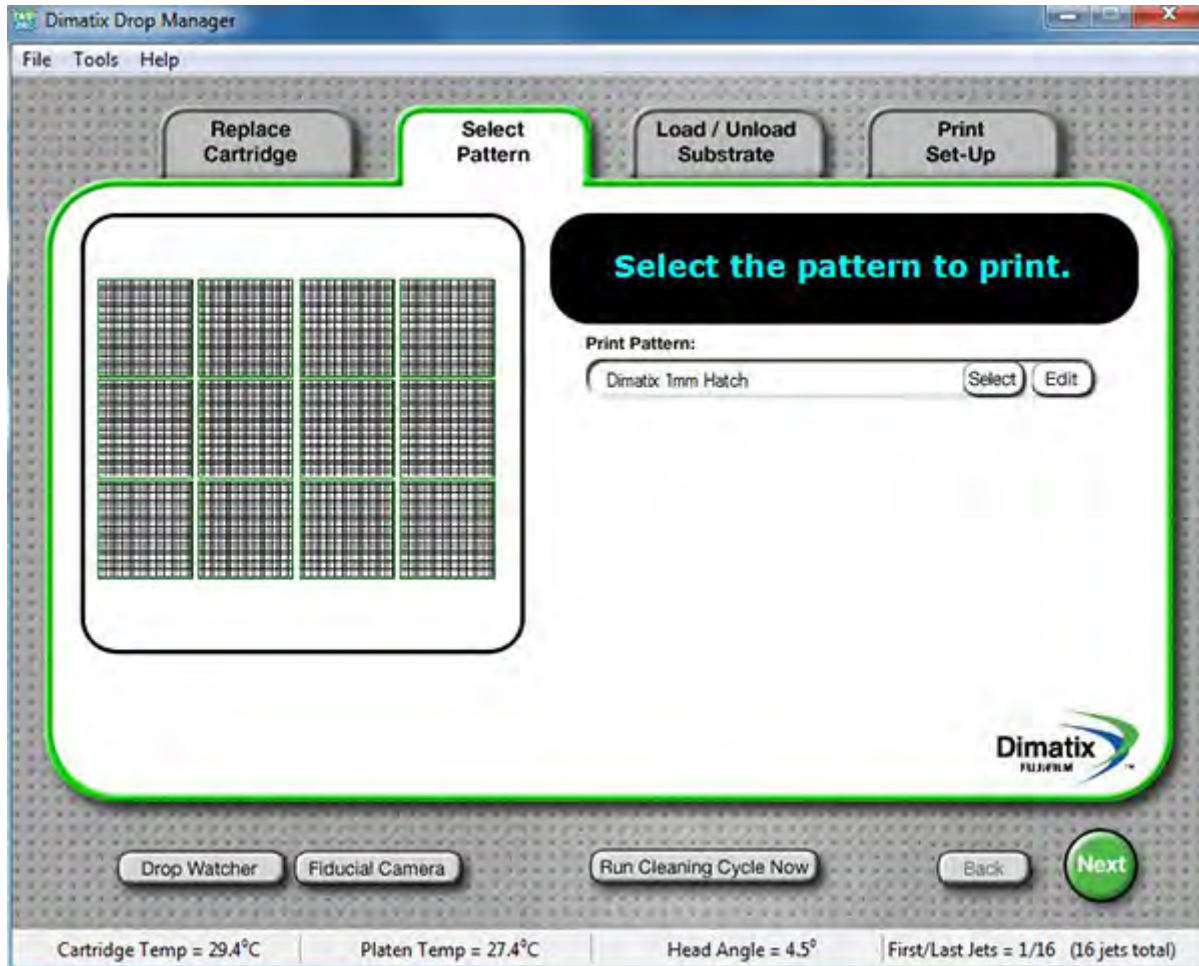

Figure 5 - 1 Select Pattern screen

From the **Select** button in the **Print Pattern** box you saw earlier that there are several predefined standard pattern files.



1.1 Predefined Standard Patterns

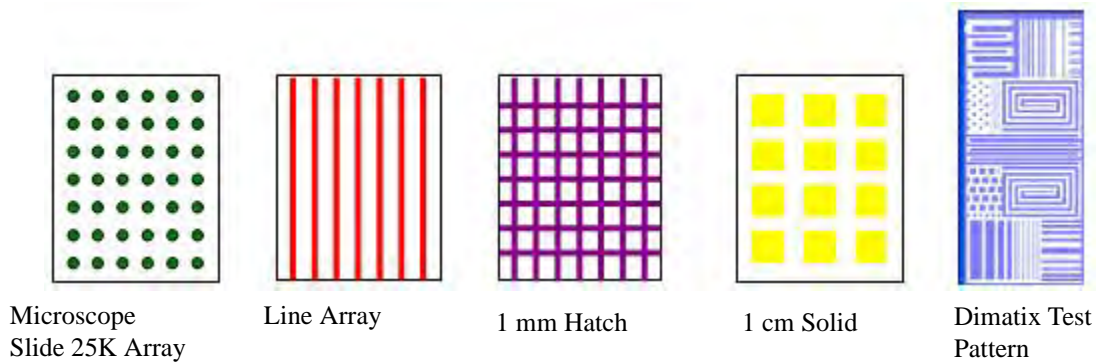

Figure 5 - 2 Predefined test patterns

2.0 Create Your Own Pattern

The **Pattern Editor** lets you create or modify patterns of drops for printing, and easily repeat them over the entire substrate if needed. The basic pattern, at the lowest level, (**Pattern Array**) is a collection of rectangles that are called pattern **Drop Position Arrays**. Each of these rectangles may be small enough to represent a single drop, or thin enough to represent a line of drops, or large enough to represent a fully filled-in rectangular area.

In all cases, X increases to the right, and Y increases toward the front of the printer. All dimension parameters are in millimeters except for the **Drop Spacing**, which is in micrometers. All dimensions entered into the pattern generator are rounded onto the Drop Spacing.



By selecting the **Edit** button on the **Select Pattern** screen the following screen appears:

Pattern Editor - Dimatix 1mm Hatch.ptn

File

Substrate

Dimensions	Leader Bar	Drop Spacing	Layers
X Width (mm) 107.020	Width (mm) 2.000	um (1270 DPI) 20	Count 1
Y Height (mm) 78.020	Gap (mm) 2.000		Interlayer Delay (sec.) 0
	<input checked="" type="checkbox"/> Enable		

Pattern Array

X Start (mm) 4.000	X Width (mm) 25.000	X Pitch (mm) 26.000	X Count 4
Y Start (mm) 1.000	Y Height (mm) 25.000	Y Pitch (mm) 26.000	Y Count 3

Drop Position Array

X Start (mm) 0.000	X Width (mm) 1.000	X Count 51	Increment Value 0.020	Preview Drops Add Delete
Y Start (mm) 0.000	Y Height (mm) 1.000	Y Count 51	Drop Area Count 2601	

X Start	Y Start	X Width	Y Height	X Count	Y Count
0.100	0.100	24.200	0.120	1211	7
0.200	0.000	0.120	25.000	7	1251
0.100	1.100	24.200	0.120	1211	7
0.100	2.100	24.200	0.120	1211	7
0.100	3.100	24.200	0.120	1211	7
0.100	4.100	24.200	0.120	1211	7
0.100	5.100	24.200	0.120	1211	7
0.100	6.100	24.200	0.120	1211	7
0.100	7.100	24.200	0.120	1211	7
0.100	8.100	24.200	0.120	1211	7
0.100	9.100	24.200	0.120	1211	7
0.100	10.100	24.200	0.120	1211	7
0.100	11.100	24.200	0.120	1211	7
0.100	12.100	24.200	0.120	1211	7

Figure 5 - 3 Pattern Editor screen

2.1 Substrate

The **Dimensions** is the total area to print. Generally most people jet on only a single substrate. But you could place several smaller substrates on the platen and jet on all of them at once. Verify that the total area is not larger than your substrate.

The **Leader Bar** is a vertical bar that can be jetted to the left of your pattern by checking the **Enable** box. This is a commonly used procedure in ink jet printing to pre-



jet nozzles to keep them active and their drop velocity uniform to improve pattern quality. The **Width** of it and the **Gap** of the leader bar can be entered in the boxes.

Note: Your pattern is automatically shifted to the right when you create a leader bar by the amount of gap and width. It is not automatically returned to its original position if you later decide to disable the leader bar.

The **Drop Spacing** is the center to center distance from one drop to the next in X and Y position to create the pattern. Although this value can be adjusted in 1 μm increments it is always rounded to the next 5 μm increment as soon as you start printing this pattern file. The X spacing is controlled by the x axis encoder, while the y axis is controlled by the cartridge angle.

Note: For the first print outs of Dimatix Model Fluid on ink jet paper a drop spacing of about 20 μm usually gives good printing results.

The **Layers** box feature allows you to reprint the same pattern over itself automatically. The **Count** number is the number of times you want to print the pattern and the **Interlayer Delay** is the delay time between each layer, additional to the amount of time spent doing any before print or after print maintenance on the cartridge.

If you click on the **Preview Drops** button, a window pops up showing the area you have designated. The total area of the window represents the platen. If the substrate area you entered is smaller than the platen it shows as a beige shape inside the white area.



Your **Pattern Array** area is delineated within the substrate area outlined.

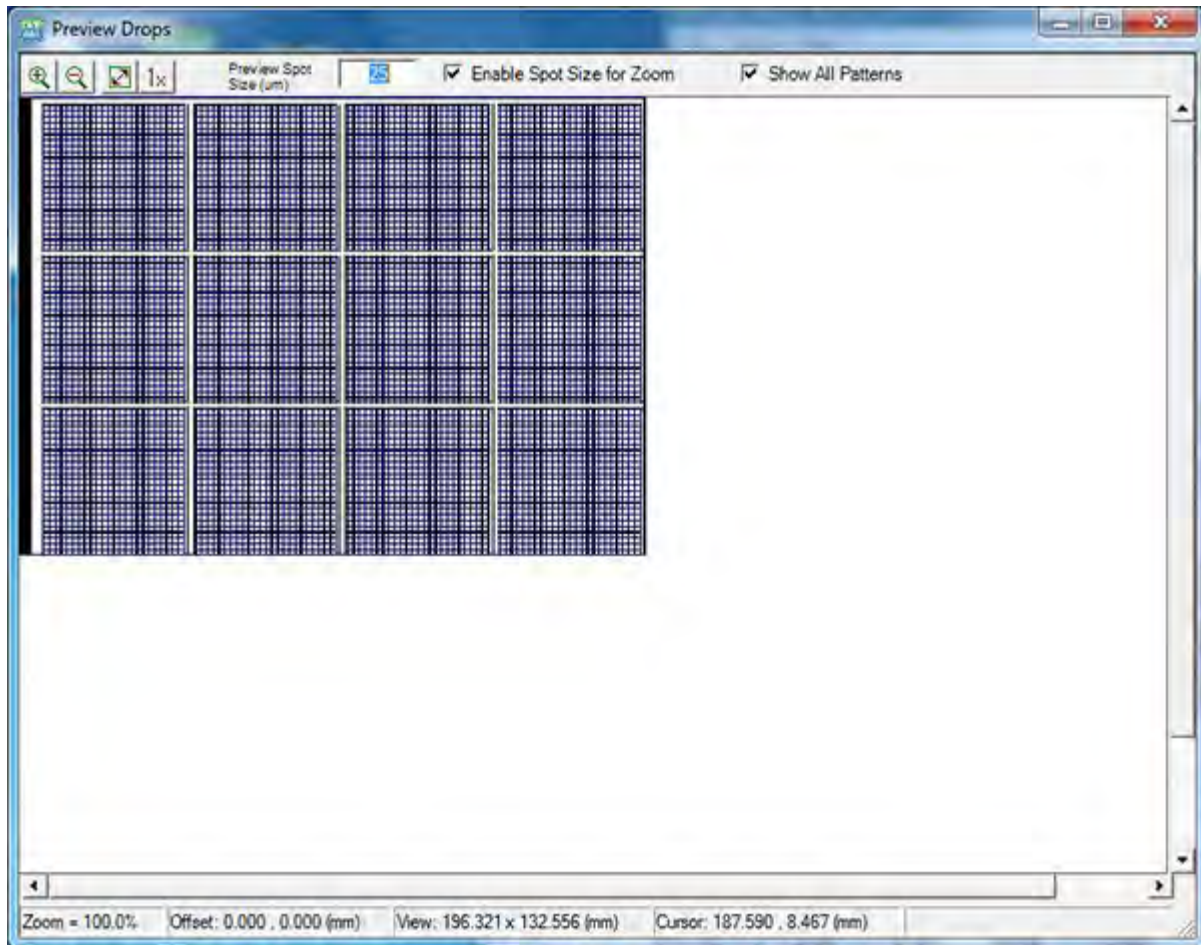

Figure 5 - 4 Pattern Block Array

2.2 Pattern Block Array

In the **Pattern Array** box enter the point on your substrate where you want the pattern to start printing in X and Y, referencing from the print origin. Then enter the **X width** and **Y height** of the block you want to make. The X and Y sizes entered should be at least large enough to enclose the collection of rectangles defined in the **Drop Positions Array** box (see below).

Note: The default print origin is approximately -1 mm, 7 mm (x,y) from the 0,0 corner scribed in the back left of the platen. See the *Fiducial Camera* section of this manual for more information.

To print a repetitive array of the pattern block in your print area, enter the X and Y **Pitch** dimensions. The **Pitch** is the distance from the start of one pattern to the next. Enter the number of patterns (**X count**) to print in the *horizontal* direction, and the number of patterns (**Y count**) to print in the *vertical* direction.



2.3 Drop Position Array

The pattern generator works with one or more user-entered rectangles of X width and Y height. There are two ways of creating a feature in a **Pattern Array**. You can enter values manually in a table or you can use the mouse to create features.

To manually create features enter the dimensions in the **Drop Position Array** group as follows and click the **Add** button. It is placed in the table on the bottom of the window.

- Enter the position (X and Y) where you want to place the first drop in your Pattern in the **Pattern Block** field.
- Then enter the width and height of the feature you want to create. For lines, enter the width/height of the line that you want. For example, for a horizontal line you would enter how long you want it to be in the x direction (**X Width**), maybe 10 mm, and for 200 μm tall you would enter 200 micrometers for the **Y Height**. For the same vertical line, it would be 200 μm **X Width**, and 10 mm **Y height**. To define a feature that is a single row of dots or a single dot, use a dimension or dimensions smaller than the value defined under **Drop Spacing**.
- The **Increment Value** is the value at which you want the dimensions to change with each click of the arrow buttons. For example an increment value of 1.000 changes the dimension 1 mm for every click of the arrow. The increment value gives you a convenient way to generate a set of related rectangles.

2.3.1 Draw feature

You can also very easily create a feature in the **Pattern Array** by hovering the mouse cursor over the **Preview Drops** window. Place the mouse cursor in a **Pattern Array**, hold the **Shift** key down and point, left click, and drag to create a rectangle. A line containing the values of your newly created feature are automatically added to the table in the **Drop Position Array** box. This is a fast way to roughly create your pattern. Later on you can edit it out by changing the values manually in the **Drop Position Array** table.

Note: Only those rectangles that are added to the table on the bottom of the pattern editor window get saved once you are done creating your pattern.

If you click on the **Preview Drops** button, a window pops up which shows you the pattern. When you click on a line of data in the table specifying a feature, that feature shows up in red on the **Preview Drops** screen. You can zoom in on the feature by drawing a rectangle with the mouse where you can see the individual spots. When you zoom in it is best to have **Show All Patterns** deselected to reduce data crunching. You can continue zooming in until you see the grid background. Then when you hold the **Ctrl** button on the keyboard and point and drag the right mouse button on your feature of interest you can zoom in and



it stays centered on the screen. You can also draw new features into the pattern by holding down the **Shift** button and dragging a rectangle with the mouse.

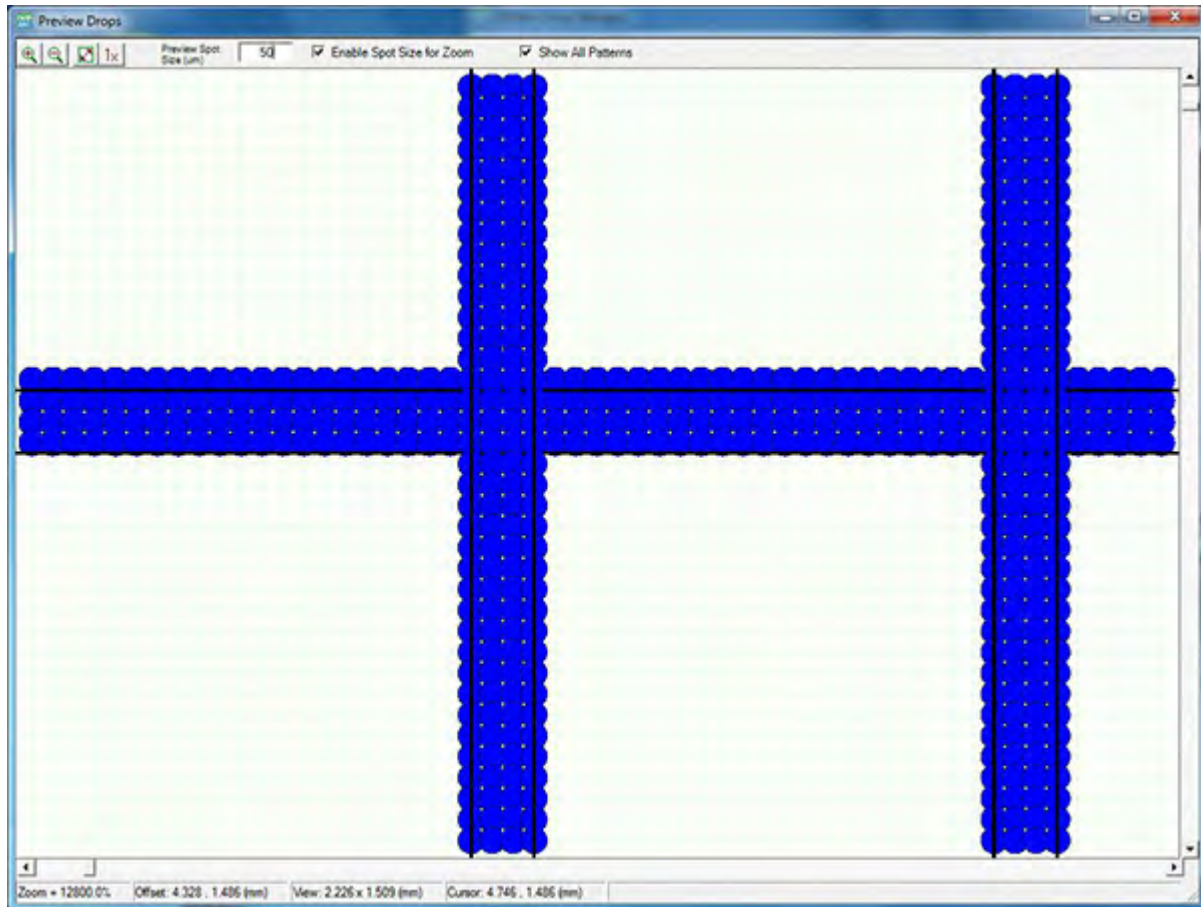

Figure 5 - 5 Preview Drops screen

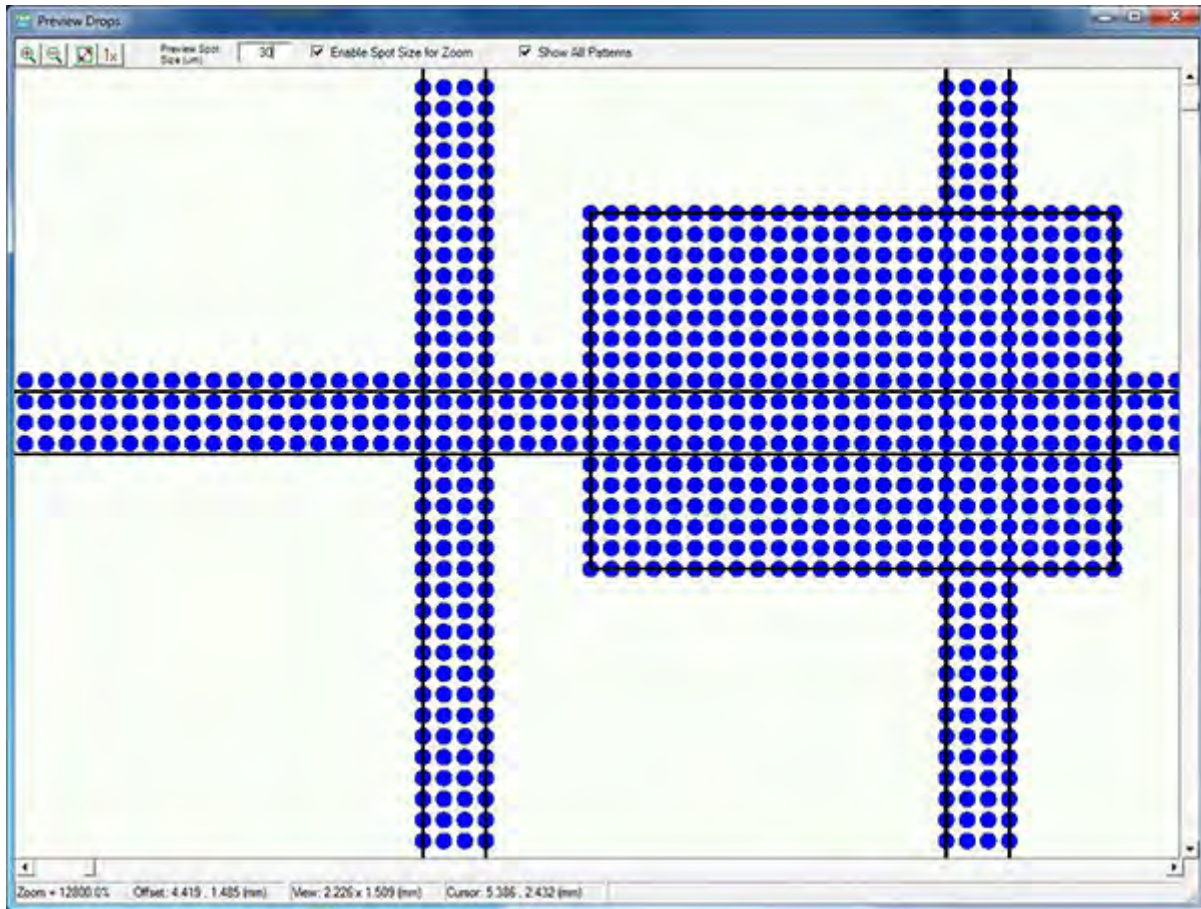

Figure 5 - 6 Zoomed In area

You can see grey lines on the screen which represent the pattern created in the pattern generator. The dots are actually where the drops are placed as the dimensions are rounded to fit on the grid you have defined in the **Drop Spacing**.

If you highlight a line in the table and click the **Add** button you duplicate that feature. It is jettied right on top of itself unless you change the **X** and **Y Start** values, which you can do by highlighting that data line in the pattern generator table and then changing the numbers in the appropriate boxes.

The **Preview Spot Size** box lets you enter the diameter of the spot that a single drop makes on your substrate. This is helpful to visualize how much separation or overlap of drops you have in the pattern features depending on their size and the drop spacing used. When reviewing the pattern to see how the features match the grid or how adjoining features line up set the **Preview Spot Size** to 10 μm .



The **Enable Spot Size** feature allows you to zoom in on the image and view the individual spots of your pattern. Putting a check in the box by clicking on it enables it. Click on it to disable it to view all of the patterns.

The **Show All Patterns** feature enables you to see all the patterns on the substrate when checked.

The **1x** button displays the pattern on the screen very close to its actual size.

The figure below illustrates how the pattern editor works. The print origin shifts if a leader bar gets used. If no leader bar is used the print origin is at the very top left of the pattern. The figure also shows that the leader gets only printed in those passes of the print head where the image has content. The leader bar might therefore have gaps in y direction.

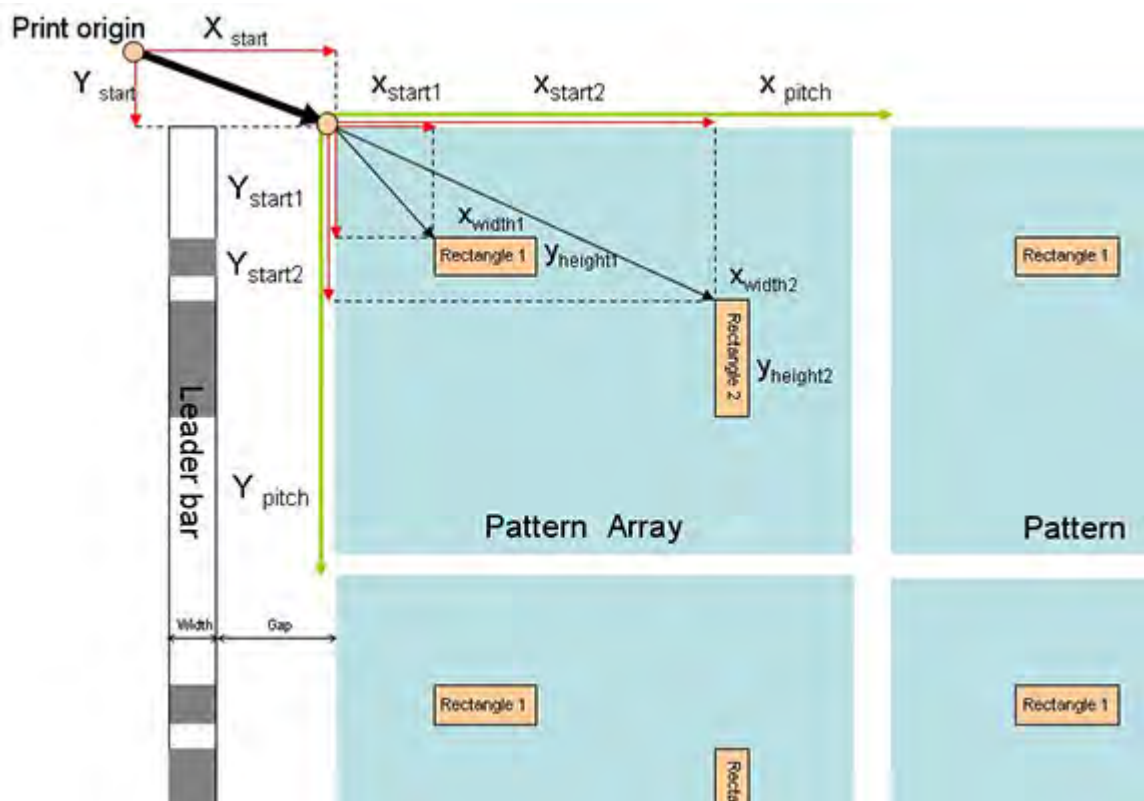

Figure 5 - 7 Pattern Editor at work

2.4 Drop Spacing

The drop spacing is the center to center distance in X and Y of the drops that the DMP deposits to create the pattern. Drop spacing is adjustable between 5 and 254 μm in one micron increments. It toggles with the arrows on the box in five μm increments. For example, with a 50 μm drop spacing, the pattern generator places drops 50 μm apart in X and 50 μm apart in Y to fill in your pattern. So, for a 100 μm wide, 10 mm tall vertical line, the system places 3 drops in the X direction (one for the first edge, another



at 50 μm , and another at 100 μm for the next edge) by 2,001 drops tall. The drop spacing therefore determines your resolution or density in the X direction and determines the angle at which the cartridge must be set to get the same resolution or density in the Y direction. The drop spacing parameter is most useful for altering the fill density (amount of jetted ink per area) of lines and rectangles, or it may be used to create rows of individual drops which are spaced closer together than 254 μm .

3.0 Bitmap File Printing

To import .BMP files into the DMP Software, select **Tools** on the DDM main window. Then select **Pattern Editor (Bitmap images)**. This opens the **Image to Pattern Converter** window. Then under **File**, select **Open BMP** to open your file.

To open a Bitmap file, set the **Drop Spacing** you want to use to print the image and then select **Open Bitmap** from the **File menu**. Then select the Bitmap file you want.

The file is processed into a pattern file at the selected drop spacing resolution.

If you want to change the pattern file resolution after it has been imported, then you must repeat the import routine with the new drop spacing setting.

Note: The Bitmap resolution must match the drop spacing setting. If it does not match at the time of import, then the image dimensions will change.

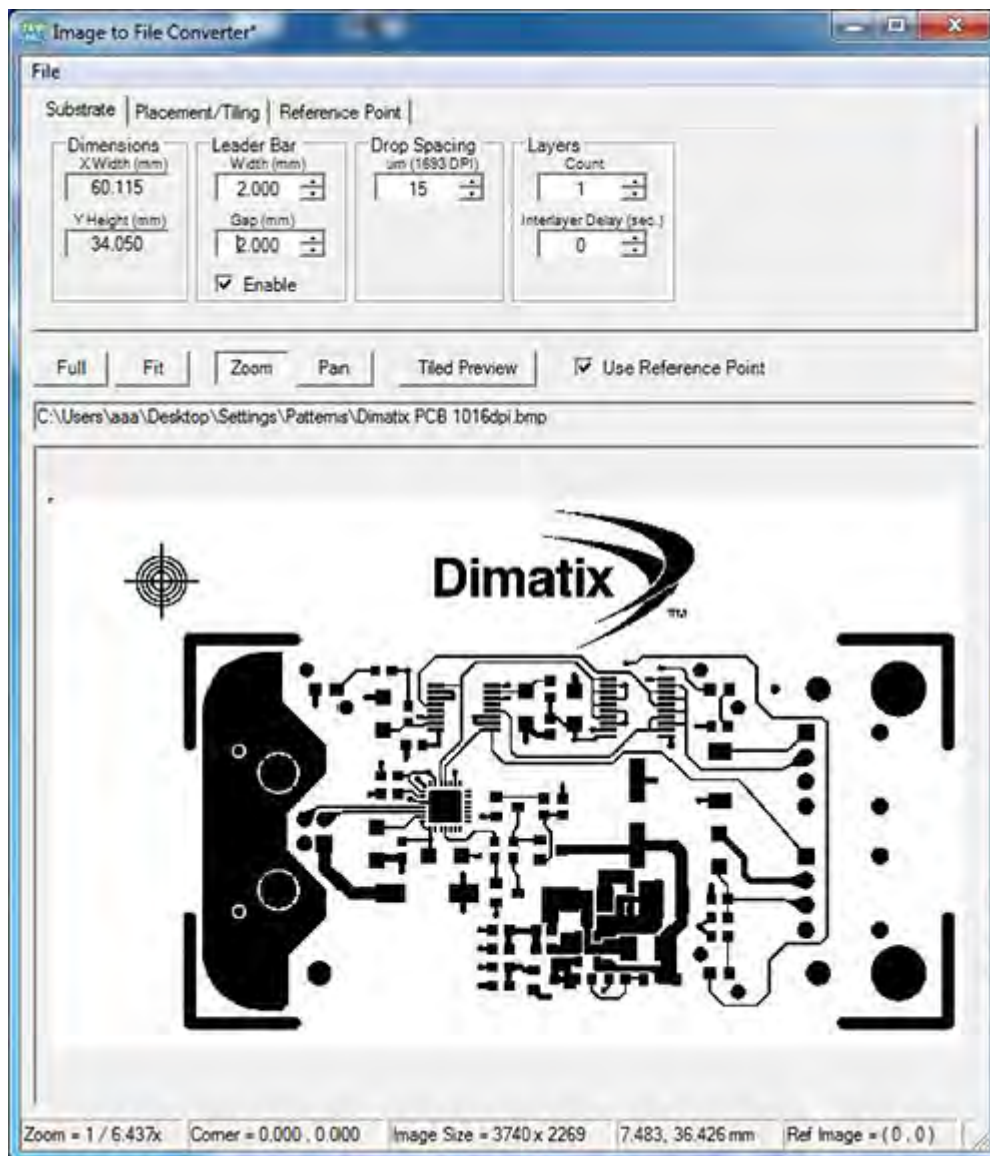

Figure 5 - 8 File Conversion screen

3.1 Substrate Tab

The **Substrate** Tab has the following features:

- **Substrate Dimensions** – this is the calculated minimum size of a substrate that is needed to print the pattern
- **Leader Bar** – this is the same feature as for pattern files. It is a vertical bar that you may add to your pattern to enhance print quality.
- **Drop Spacing** – this is the same as for pattern files, it is the spacing of the drops (center to center) in x and y that are jetted to create the pattern.



- **Layers** – this is the same as for pattern files and allows re-printing the same pattern over itself several times (**Count**) with or without a delay (**Interlayer Delay**) between.

The **Full**, **Fit**, **Zoom**, and **Pan** enable movement and zooming of the image. When an image is first loaded it zooms to **Fit**. This shows the full extents of the bitmap. Clicking the **Full** button zooms in on the image to the point where each pixel in the .BMP file is displayed as a pixel on the screen. The form may be resized to provide a larger preview.

If the **Zoom** button is selected, then clicking and dragging the left mouse button over the image creates a zoom window. When the mouse is released the image zooms to the selected area. If **Pan** is selected, clicking the left button and dragging in the image moves the viewable image in the window. These controls can be used to view the high resolution data and aid in selecting the reference point.



The **Tiled Preview** button allows viewing of all the patterns to be printed.

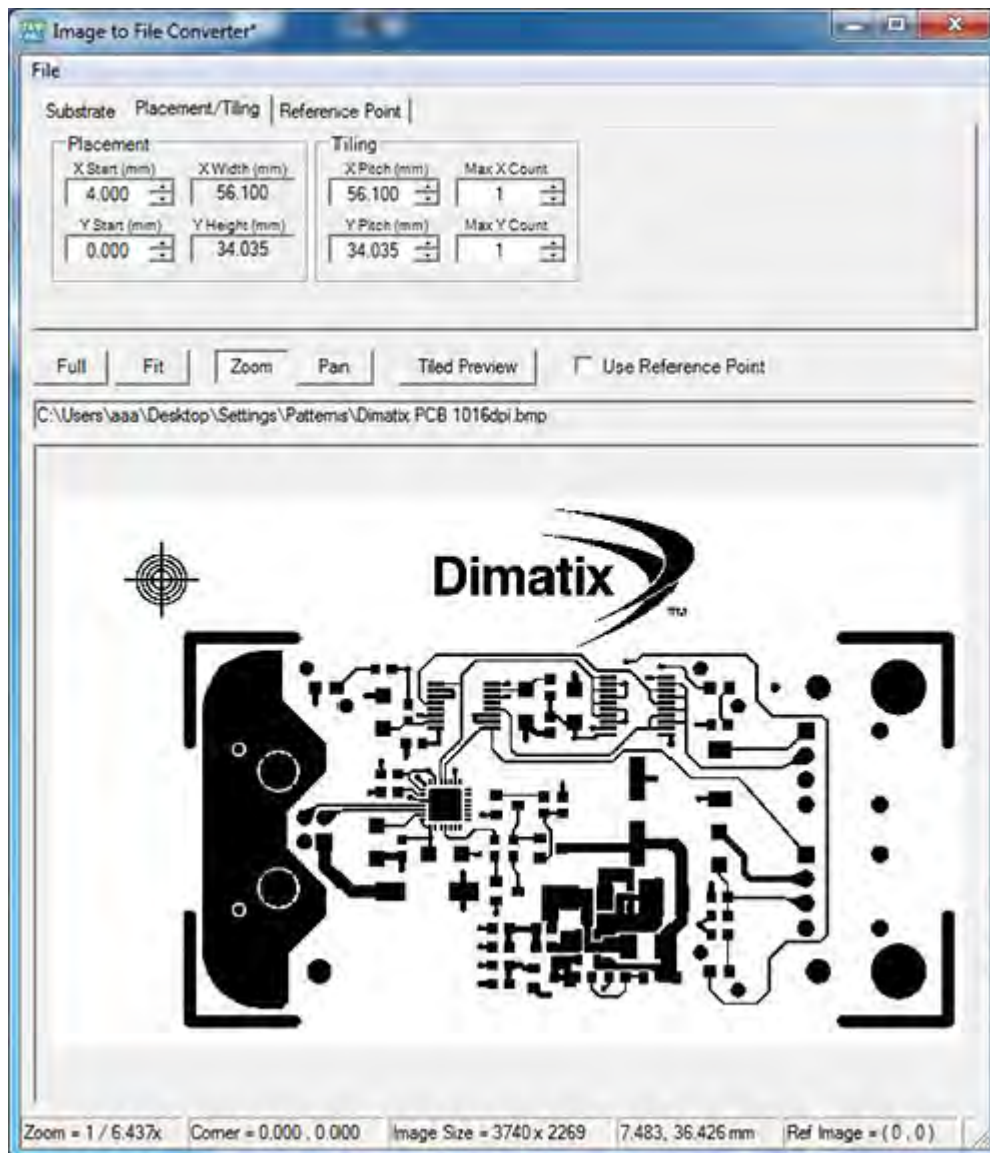

Figure 5 - 9 Placement/Tiling Tab

3.2 Placement

X Start, **Y Start** is the position relative to the print origin that the pattern starts.

X Width, and **Y Height** is the calculated size of the pattern.



3.3 Tiling

This is used to make multiple print copies of the same pattern. The **Pitch** is the distance from the beginning of one pattern to the next as set in **X Pitch** and **Y Pitch**. The number of patterns is set by the **Count**.

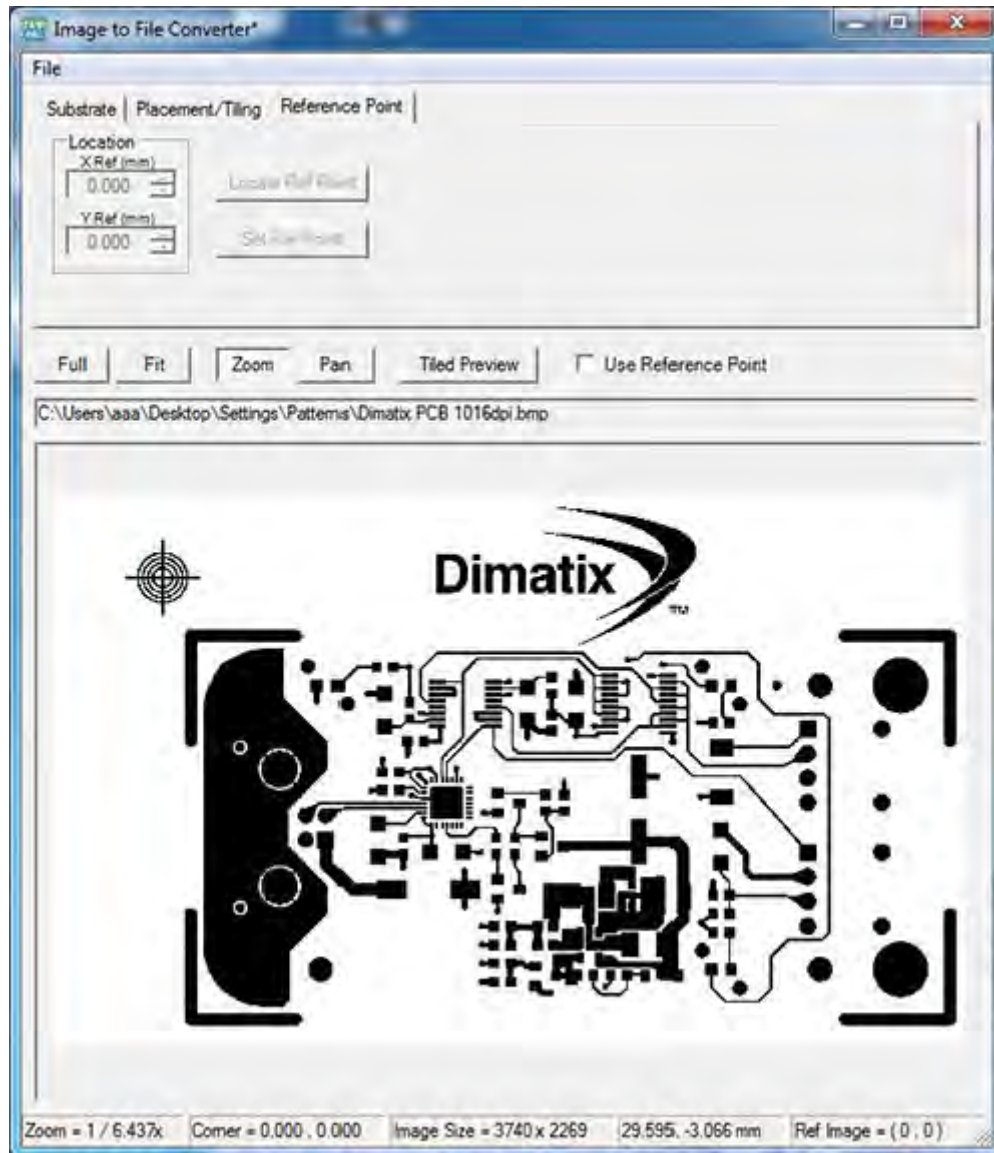

Figure 5 - 10 Reference Point Tab

3.4 Reference Point

The **X Ref**, **Y Ref**, **Locate Ref Point**, and **Set Ref Point** provide an additional way to position the image by aligning a point in the image to a specific point on the substrate (a



point is selected in the image and a corresponding point is selected in the **Fiducial Camera** window).

- To print using a Reference Point in your image, check the box **Use Reference Point**.
- To set a reference point, first locate the part of the image you wish to align to by either using **Zoom** or **Pan**. Click **Set Ref Point**. Then place the cursor on the point in the image and click on it with the left mouse button. Or, if you know the dimensions for the **Reference Point** you can type them in directly into the **X Ref**, **Y Ref** boxes then click **Locate Ref Point**. This takes you to that specific point in the image. The cross hair cursor that displays the reference point shows where the pattern is printed. You can make fine adjustments by clicking the arrow up/down buttons next to the **X Ref** and **Y Ref** boxes. You must save the file once you select the point for the DMP to utilize it.
- To complete the **Reference Point** usage, go to the **Fiducial Camera** window (see *Fiducial Camera* section). Click on the **Fiducial Camera** button on the main DDM window to open the fiducial camera.
- In the **Tools** menu of the Fiducial Camera window click on the Set Reference Point button.
- Find the point on your substrate where you want to place your selected image Reference Point by moving the camera to the desired position. Place and click the cursor on your point.
- Click the **Use Reference Point** box on the Fiducial camera window.
- Do not close the **Fiducial Camera** window before you print. It must stay open. Click the **Print** button on the main **DDM** window **Print Set-Up** tab.

The **X Width** and **Y Height** values are filled in when a file is loaded. The size is based on the image size and the drop spacing. Bitmap files must be printed at the drop spacing (resolution or dpi) they were created for, or the image size changes accordingly. To convert from drop spacing to resolution:

$$\text{Drop Spacing [dpi]} = 25400 / \text{Resolution } [\mu\text{m}]$$

A status bar at the bottom shows the current zoom factor, the location of the upper left of the preview, and the image size. The current cursor position is also displayed.

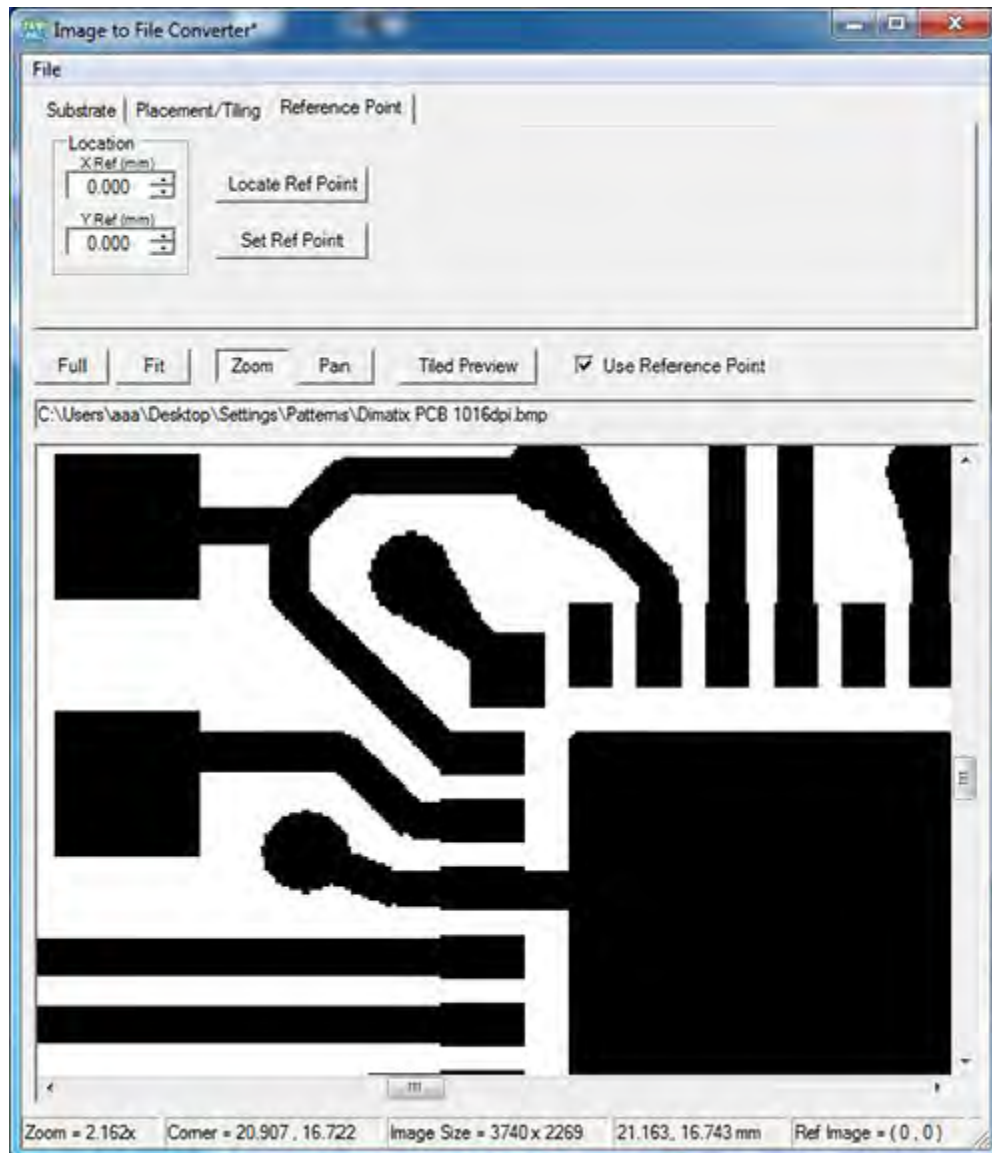

Figure 5 - 11 Reference point settings

When all of the parameters are correct you must save the file as a pattern file (it has a .ptf extension). The pattern file is what can be selected from the main form or the fiducial form to print.

Note: Gerber files or other vector based files can be converted to bitmap files using the ACE Translator software that is installed on all of our DMP2800 controller computers. You can find detailed instructions on how to use this software in the techsupport section on www.dimatix.com.



4.0 Print Preview

The print preview can be disabled or enabled in the **DDM** main window **File** menu. If it is on, it shows a preview before the printing starts. The title bar of the dialog tells if the reference or printing origin is being used. The print origin (or reference point) is marked with a cross hair. The leader bar is shown if it is enabled.

The preview is sizable so it can be made full screen for more detail. Remember, the platen area is not the substrate. The user has to make sure the substrate is placed correctly on the platen and that it fits the image they are going to print. The preview is meant to make sure that the origin and tiling are set correctly.

The following are some sample screen shots using the reference point and leader bar on a tiled pattern. The reference image used in this example is the lower right one of the array and there is a leader bar:

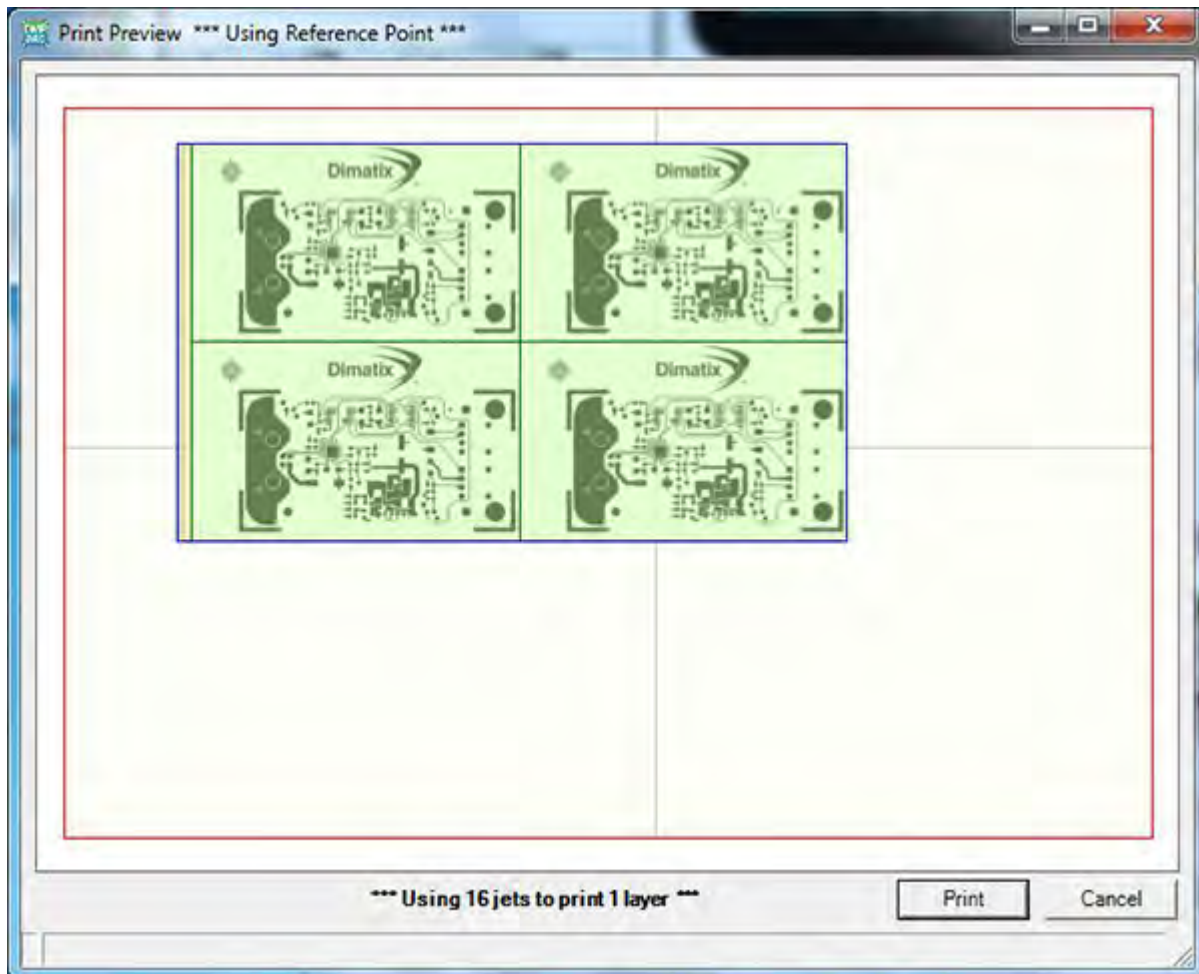

Figure 5 - 12 Print Preview – Reference point



This example shows a tiled array, using a print origin, without a leader bar.

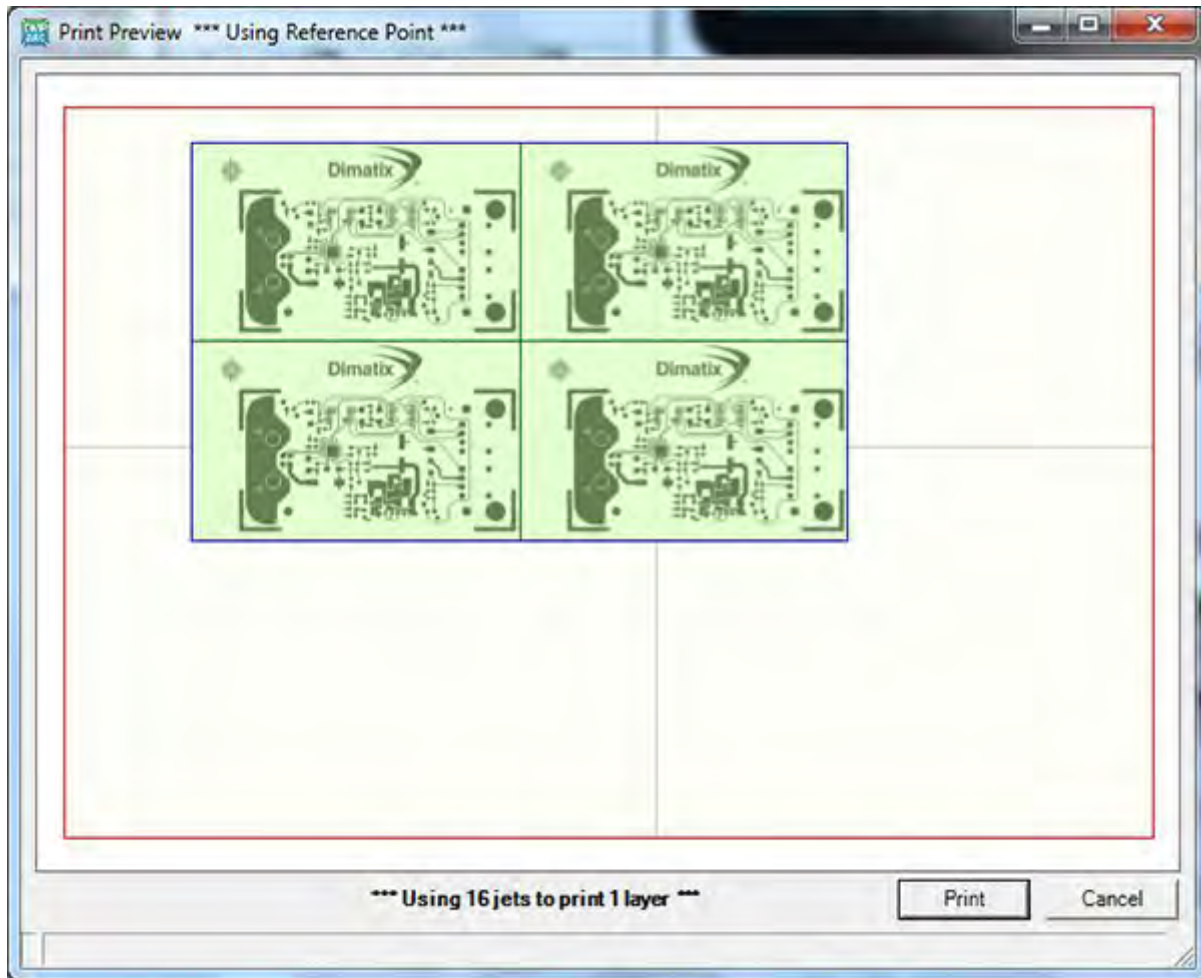

Figure 5 - 13 Print Preview – Print Origin without leader bar



A tiled image with a bad reference point.

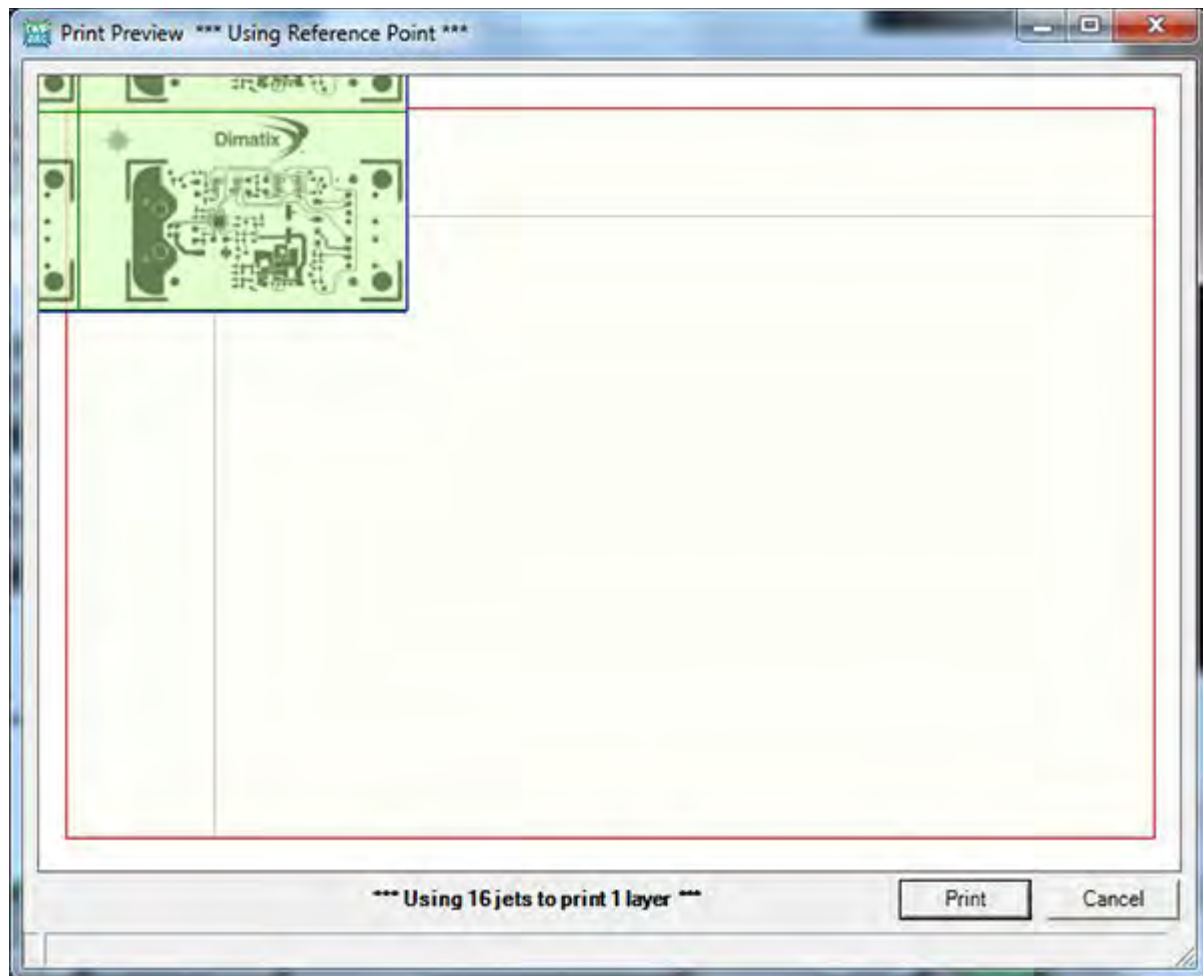

Figure 5 - 14 Using a bad reference point

The error message you get if you try to print from an origin that takes the image off the printable platen area.

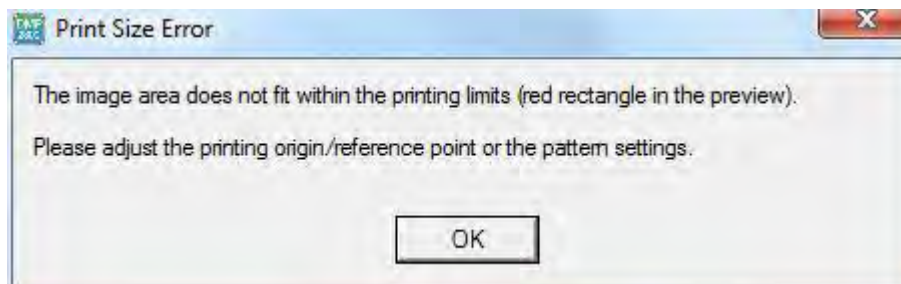

Figure 5 - 15 Image area message



5.0 Cartridge Mounting Angle

Before you jet your pattern, the system calculates the angle to set the cartridge determined by the drop spacing specified in the pattern. This angle adjustment is what lets you modify the drop spacing in the Y axis.

The following is a top view of the carriage. There are two sets of scales. The outer scale is the cartridge angle scale, and the inner scale is the vernier scale to adjust the head angle to 0.1 degree increments. Release the latch by pulling it forward freeing the carriage plate to rotate.

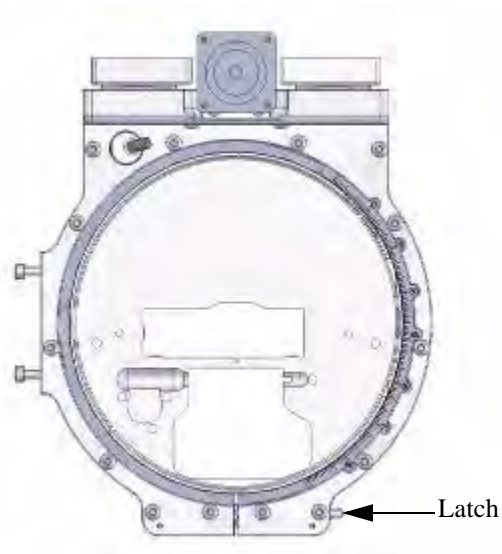

Figure 5 - 16 Carriage latch



The following is a close-up of the cartridge angle alignment scale set to 0 degrees. The outer main scale is in one degree increments. There is a notch on the 0 point of the inner vernier scale is lined up with the 0 on the outer cartridge angle scale.

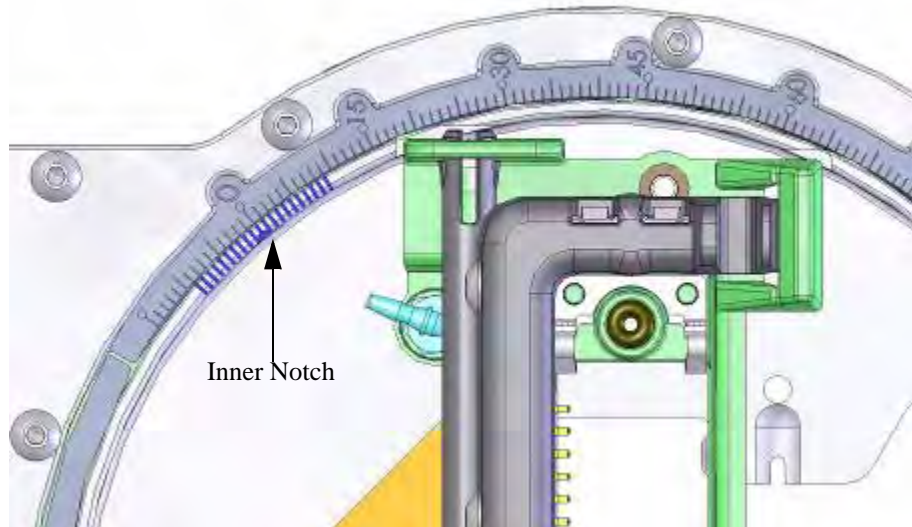
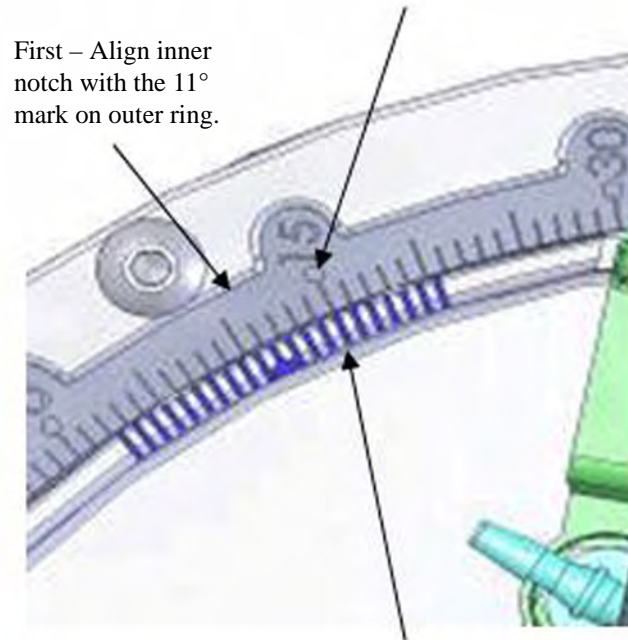

Figure 5 - 17 Cartridge Alignment scale

The following picture shows how to set the cartridge angle to 11.4 degrees. The 0 notch on the inner vernier scale is a little past the 11 degree mark. The next inner mark on the vernier that is lined up with a mark on the outer ring is line 4. This gives 11.4 degrees.



Third – Align the fourth mark on the inner ring with the closest graduation mark on the outer ring. In this case, the 15° mark. The head angle now equals 11.4°.



First – Align inner notch with the 11° mark on outer ring.

Second – Count up four marks from the notch on the inner ring.

Figure 5 - 18 Setting the cartridge angle to 11.4°

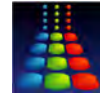

The following table shows the relationship of saber angle, resolution, and drop spacing for the resolutions that the printer is capable of printing.

Table 5 - 1 Resolutions Relationships

Resolution [dpi]	Sabre angle [°]	Drop spacing [μm]		Resolution [dpi]	Sabre angle [°]	Drop spacing [μm]
5080.00	1.1	5		188.15	32.1	135
2540.00	2.3	10		181.43	33.4	140
1693.33	3.4	15		175.17	34.8	145
1270.00	4.5	20		169.33	36.2	150
1016.00	5.6	25		163.87	37.6	155
846.67	6.8	30		158.75	39.0	160
725.71	7.9	35		153.94	40.5	165
635.00	9.1	40		149.41	42.0	170
564.44	10.2	45		145.14	43.5	175
508.00	11.4	50		141.11	45.1	180
461.82	12.5	55		137.30	46.7	185
423.33	13.7	60		133.68	48.4	190
390.77	14.8	65		130.26	50.1	195
362.86	16.0	70		127.00	51.9	200
338.67	17.2	75		123.90	53.8	205
317.50	18.4	80		120.95	55.8	210
298.82	19.6	85		118.14	57.8	215
282.22	20.8	90		115.45	60.0	220
267.37	22.0	95		112.89	62.4	225
254.00	23.2	100		110.43	64.9	230
241.90	24.4	105		108.09	67.7	235
230.91	25.7	110		105.83	70.9	240
220.87	26.9	115		103.67	74.7	245
211.67	28.2	120		101.60	79.8	250
203.20	29.5	125		100.00	90	254
195.38	30.8	130				

Note: You may want to copy the above table and place it next to the DMP for future reference.

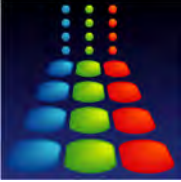

Drop Watcher

1.0 Drop Watcher

In the bottom left of the main **DDM** window is the **Drop Watcher** button. Clicking on it moves the carriage to the right side of the platen, positioning the nozzles over the drop watcher camera system. This system allows direct viewing of the jetting nozzles, the faceplate surrounding the nozzles, and the actual jetting of the fluid. The **Cartridge Settings** window also comes up at this time to allow you to modify the waveform and view the changes in jetting characteristics.

Note: **Tickle Control** is not active (displayed in gray) when you open the **Cartridge Settings** window via the drop watcher. In order to be able to change tickle control, open the cartridge settings window directly by clicking the **Edit** button in the **Print Setup Tab** in the **DDM**.

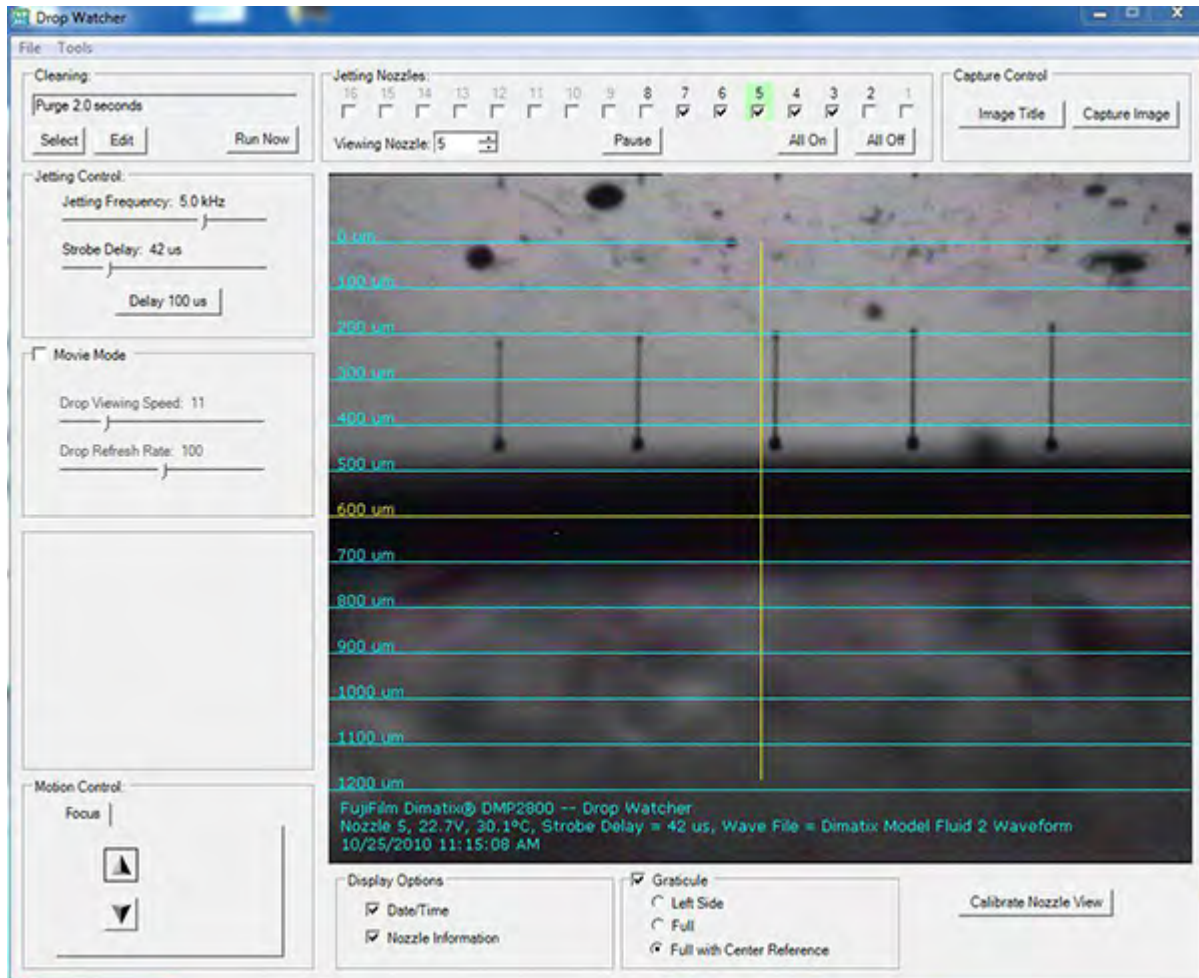

Figure 6 - 1 Drop Watcher screen

1.1 Jetting Nozzle Box

Once the carriage and cartridge are in position, click on the **Jetting Nozzle** box – number 8 should be in the box. When you click on it, the system brings nozzle number 8 of the cartridge into the center of the screen. You can then increment up or down to different nozzles and the system moves that nozzle into center position in the screen. There is also a row of the nozzle numbers across the screen in which you can turn any of them on or off.

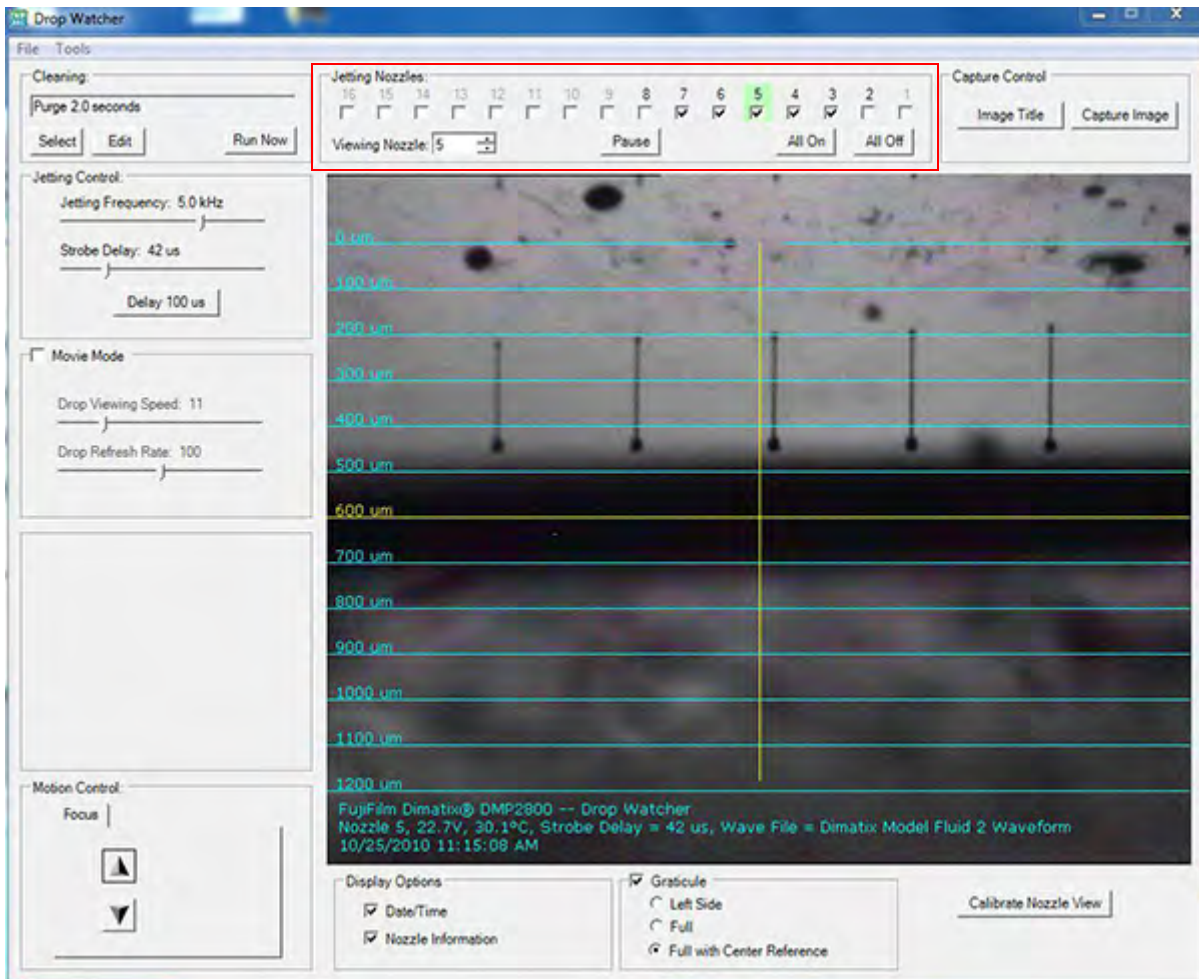

Figure 6 - 2 Jetting Nozzles box

By clicking the box associated with each nozzle it ejects drops out of that nozzle or turns it off. By right clicking a box, the nozzle moves to center position. The nozzle in center position always has a green shade. To minimize spraying off of the absorbent **Drop Watch Pad**, the user interface limits selecting jetting nozzles to the four surrounding the **Viewing Nozzle**.

1.2 Calibrate Nozzle View

The **Calibrate Nozzle View** feature automatically controls the stage motion to keep the nozzles in line when drop watching regardless of the cartridge angle. To perform this operation use the following procedure:



Start by clicking on the **Calibrate Nozzle View** button in the lower right of the **Drop Watcher** screen.

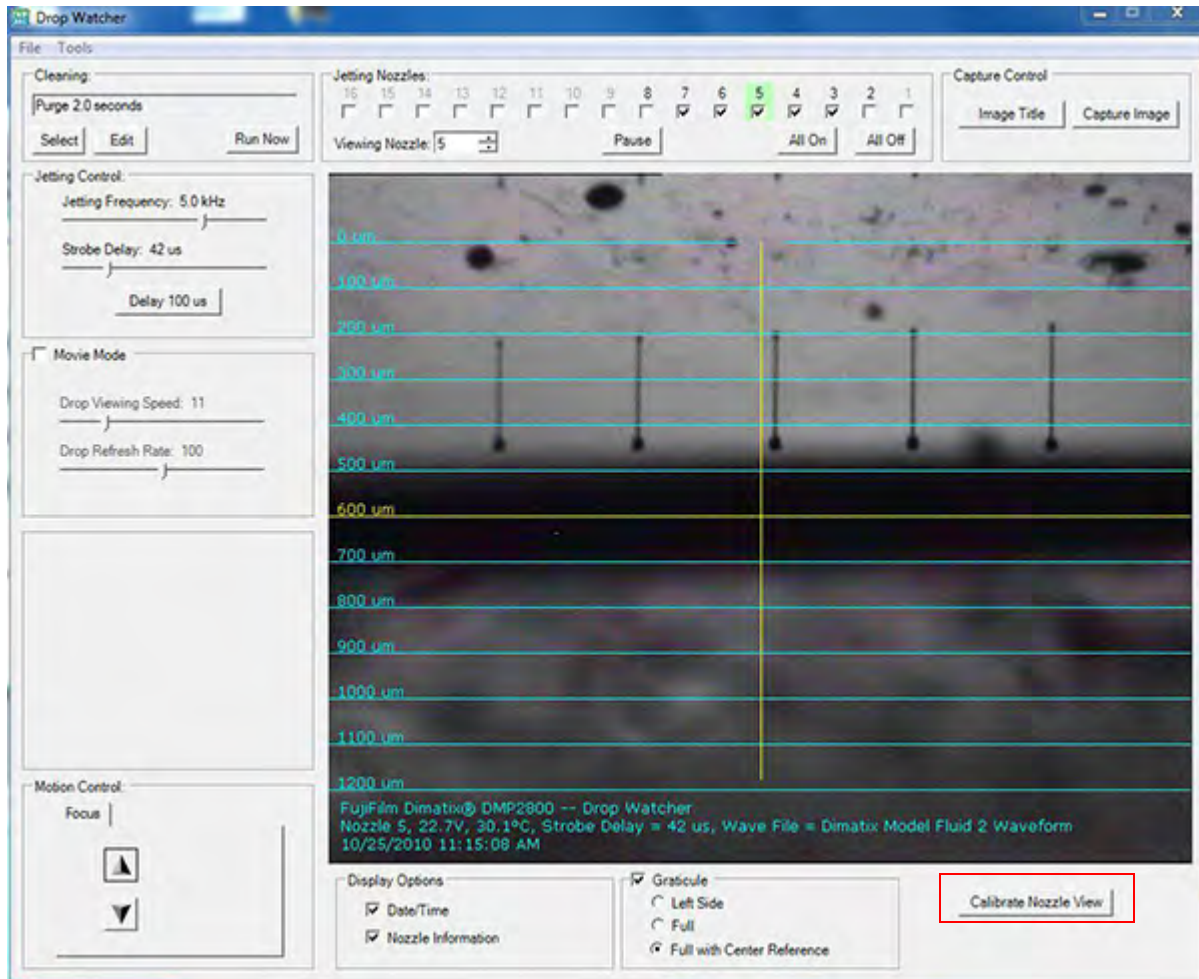

Figure 6 - 3 Calibrate Nozzle View button

1. Find nozzle 1 (the right most orifice), put the mouse pointer on the nozzle and click-drag it to the cross-hair on the screen. Use the focus buttons as necessary to refine the nozzle's focus.
2. Click the **Next** button and drag the image to the right until nozzle 16 (the left most nozzle) is under the cross-hair. Use the focus buttons again as necessary to refine the nozzle's focus.
3. Click the **Next** button again and you are done calibrating the nozzle view. Now, when you select any nozzle from one to sixteen, the selected nozzle should be close to the 0 line opening and in focus.

For the stage to move the selected nozzle into position you must index through the nozzles using the **Jetting Nozzle** box. When you open the drop watcher it tries to



center nozzle #8 in the middle of the screen and put nozzle 8 in the **Jetting Nozzle** box. By clicking the cursor in the box it turns the nozzle on and moves it up to the 0 line.

Note: The **Calibrate Nozzle View** feature can also be accessed by selecting the **Calibrate Nozzle View** option of the **Tool** menu.

1.3 Cleaning Box

If you want to do a maintenance cycle to improve jetting, you can do that by clicking on the **Run Now** button on the **Cleaning** box in the upper left corner of the window.

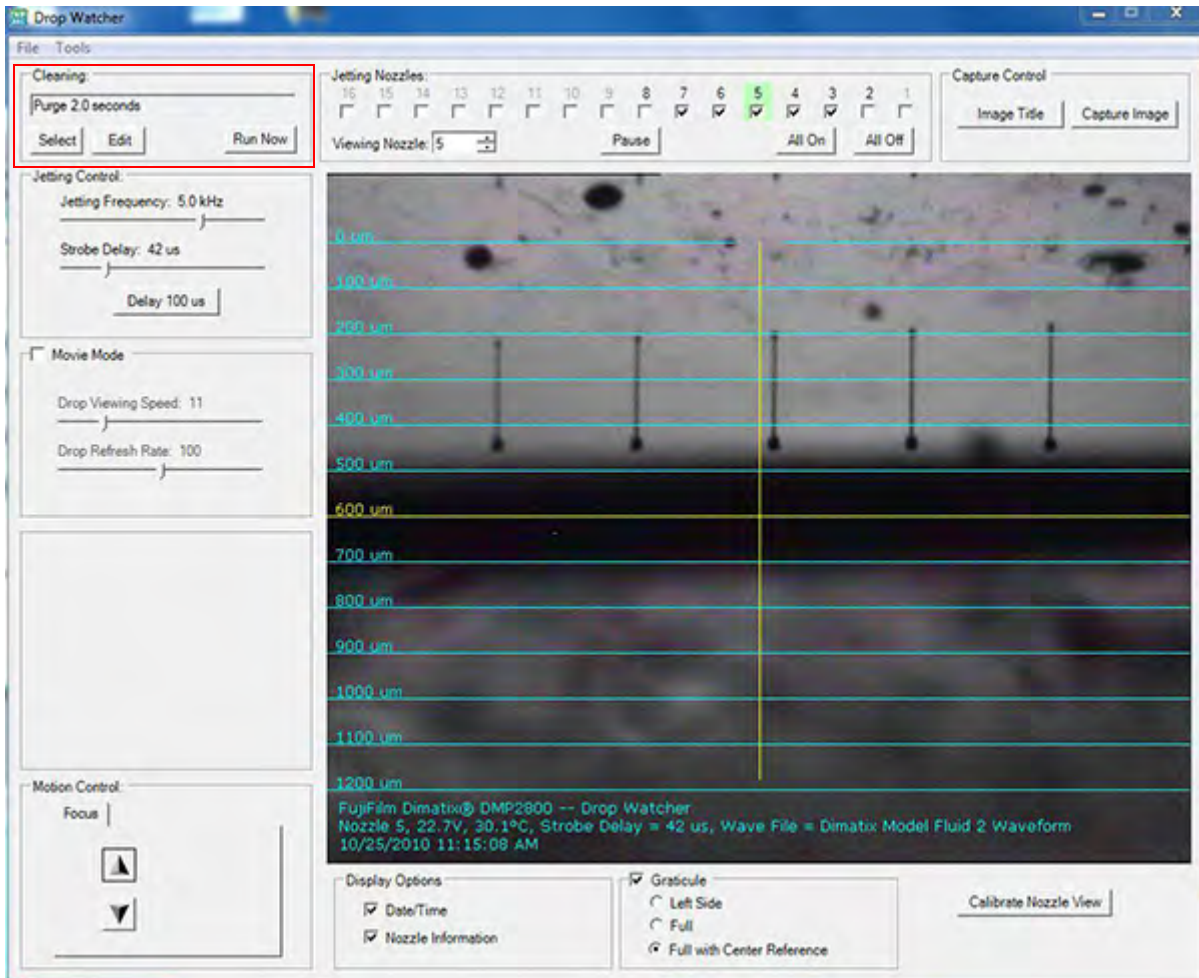

Figure 6 - 4 Cleaning box

1.4 Motion Control Box

There are two arrow buttons near the bottom left of the screen, which allow you to **Focus** the drop watcher camera on the nozzles and drops by clicking repeatedly until the image is



in focus. Holding down these buttons results in the camera moving with increased increments.

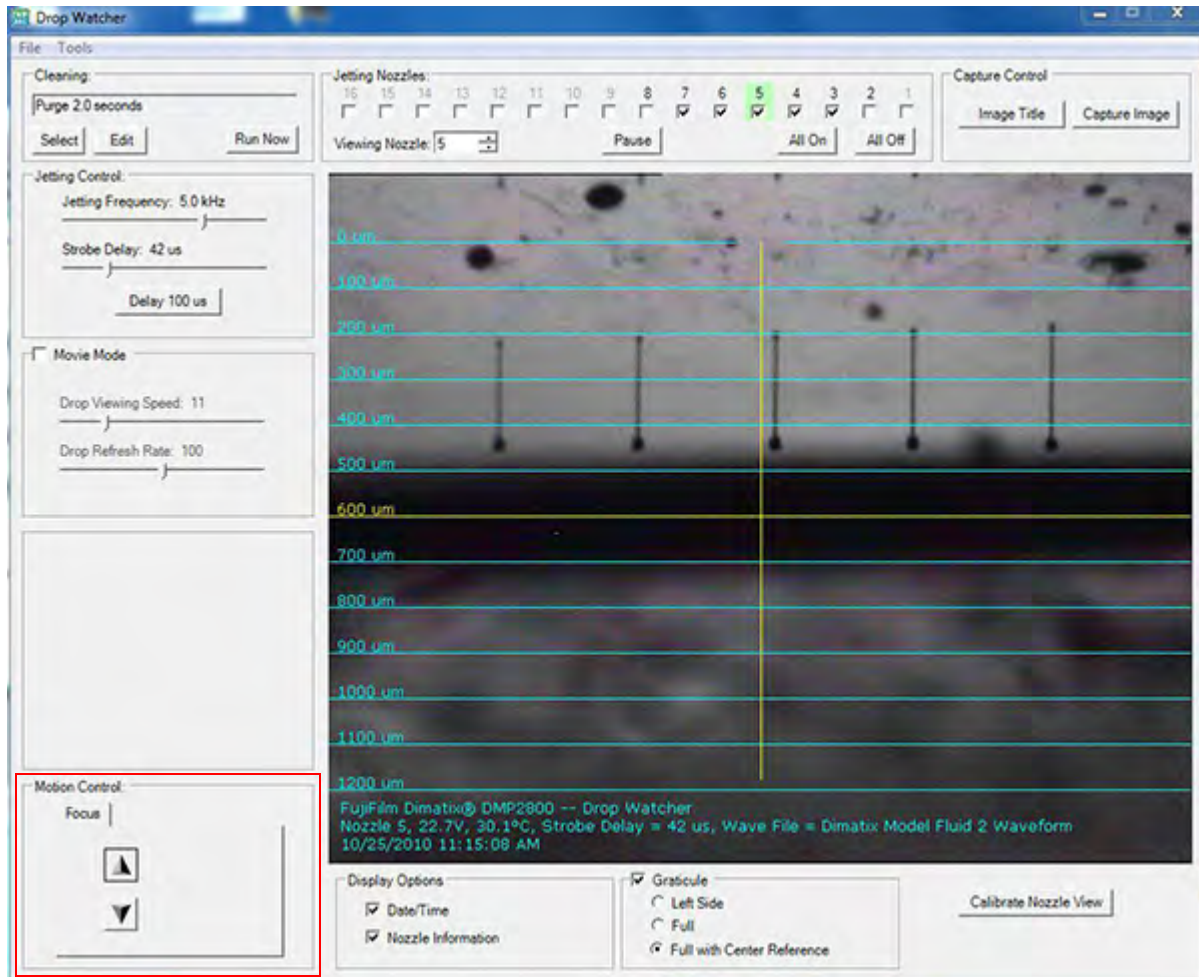

Figure 6 - 5 Motion Control box

1.5 Drop Watcher Pad

The drop watcher pad is located in the center of the drop watcher mechanism and acts as the receptacle for fluid during jetting. It needs to be changed periodically as it absorbs fluid. Typically this occurs when you see stray drops being deposited on the nozzle surface during drop watching or fluid is covering the side of the pad holder. To replace the pad simply pull out the holder and insert a new one.

1.6 Viewing Modes

The drop watcher system provides you with two different viewing modes.

If you select the **Movie Mode** check box, it lets you watch a stroboscopic movie of drops in flight as they are ejected from the nozzle. This is real time continuous jetting



of the nozzles. Checking this box also changes the buttons **Image Title** and **Capture Image** to **Movie Title** and **Capture Movie**.

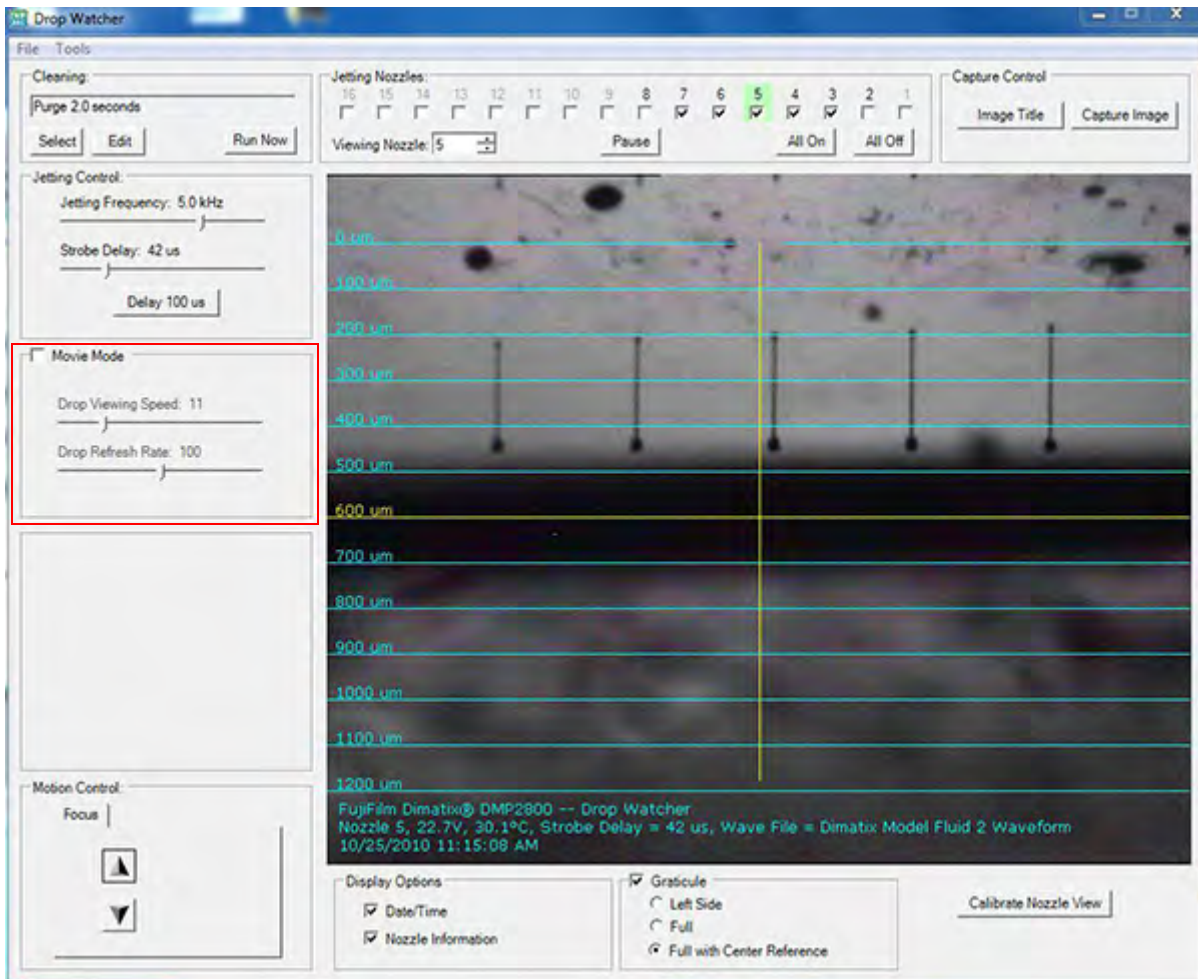

Figure 6 - 6 Movie mode box

- The **Drop Viewing Speed** slider changes the sweep rate of the delay of the strobe while in **Movie Mode**. This has the effect of making the appearance of drop formation go faster or slower.
- The **Drop Refresh Rate** slider adjusts the time at which the sweep delay starts over thereby adjusting how long you see a drop in flight.
- If the **Movie Mode** check box is not checked, then the drops appear to be frozen in flight. This mode can be used for closer inspection and measurement. By adjusting the strobe delay you freeze the drop at different positions after it leaves the nozzle. Notice that this is still real time continuous jetting.
- You can click on the various nozzles to see how they perform.



In the **Graticule Group** different versions of the video window's leader bar or scale are available.

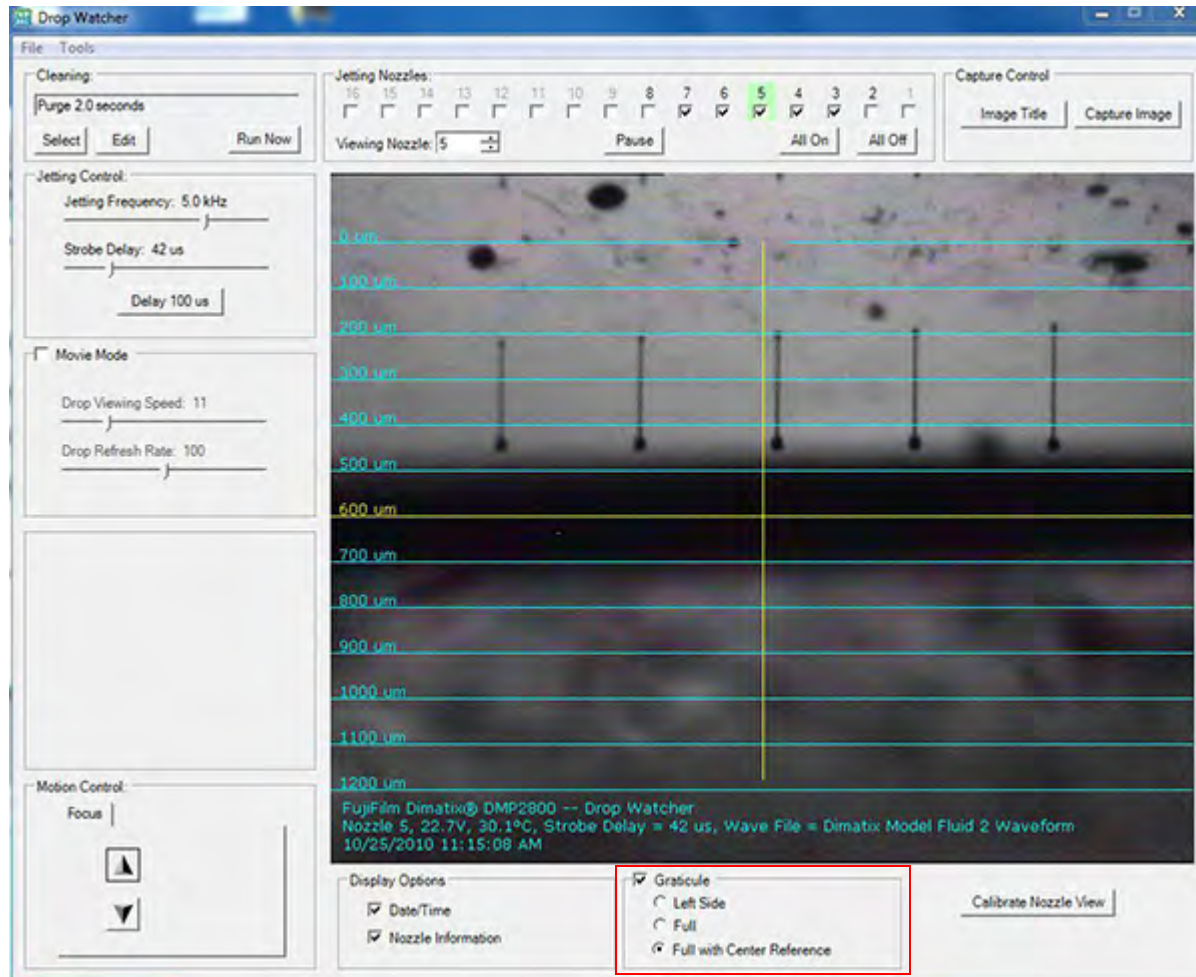

Figure 6 - 7 Graticule Group box



The **Display Options** lets you turn on or off the image information.

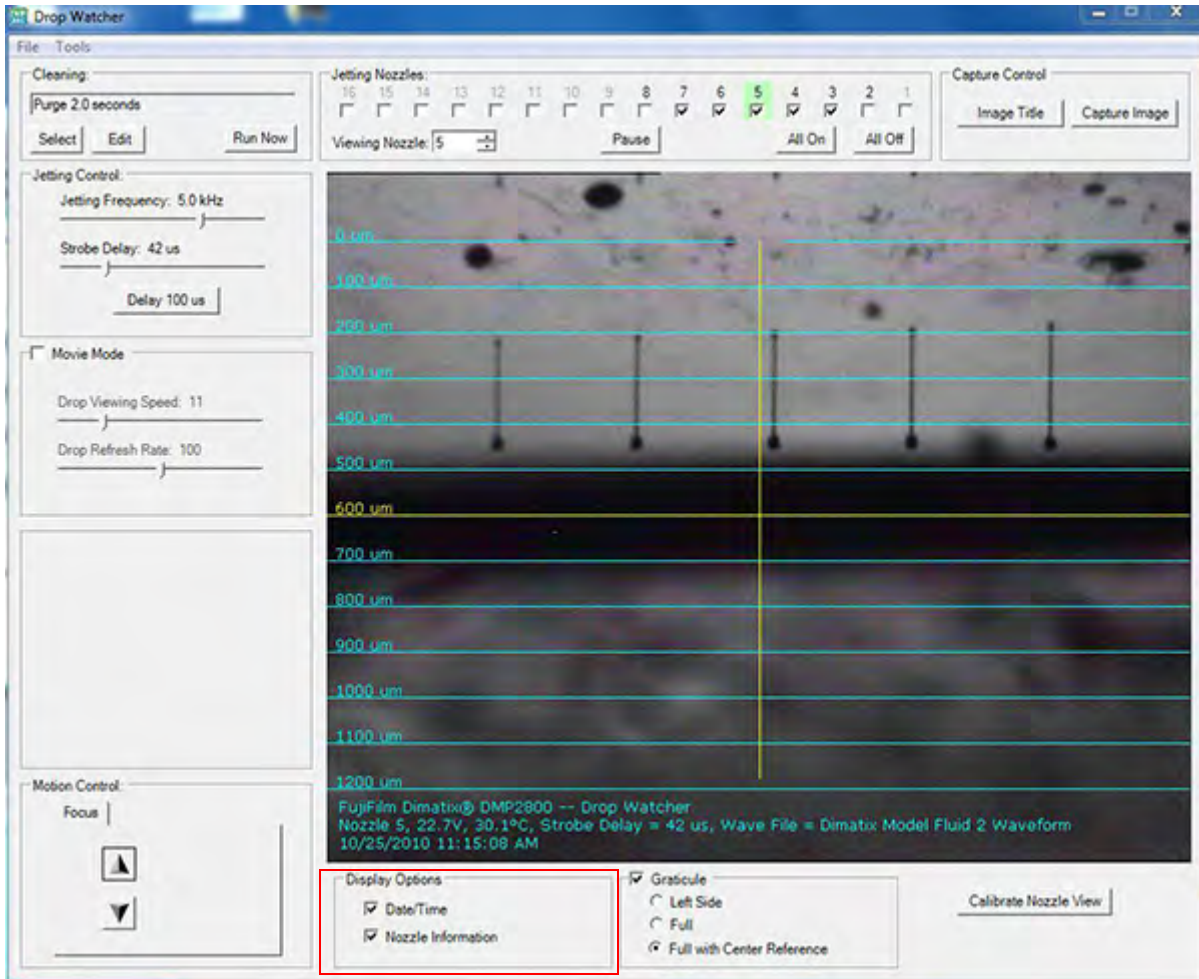

Figure 6 - 8 Display Options box



The **Capture Control** group allows you to store a still image or video of the jetting with all the conditions and information on it.

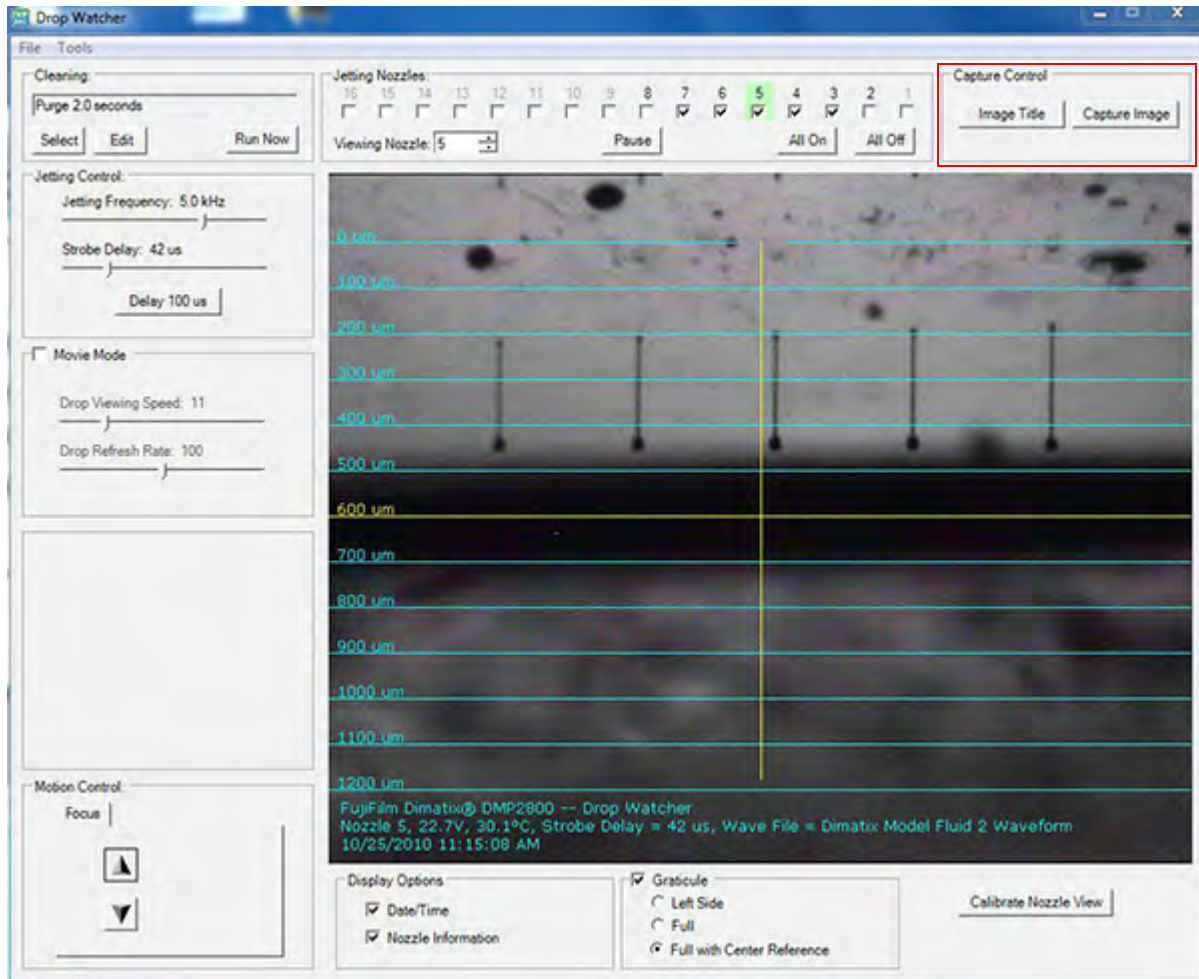

Figure 6 - 9 Capture Control box

- The **Image/Movie Title** button allows you to put a title at the bottom of the screen in the image after Dimatix DMP2800 - *Your Title Here*. The nozzle number that you are viewing, the jetting voltage, the cartridge temperature, the waveform file name, and the date and time are automatically stored on the image.
- The **Configure Movie Capture Quality** in the **Tools** menu allows you to adjust the quality (and subsequently the file size) of the movie.
- A way to get to high quality videos and low file size is to use a video editing tool like the standard **Windows Movie Maker** to compress the video. The **Drop Watcher** software initially creates huge .avi files.



The following screen appears.



Figure 6 - 10 PCI Video Capture screen



Jetting Control Box

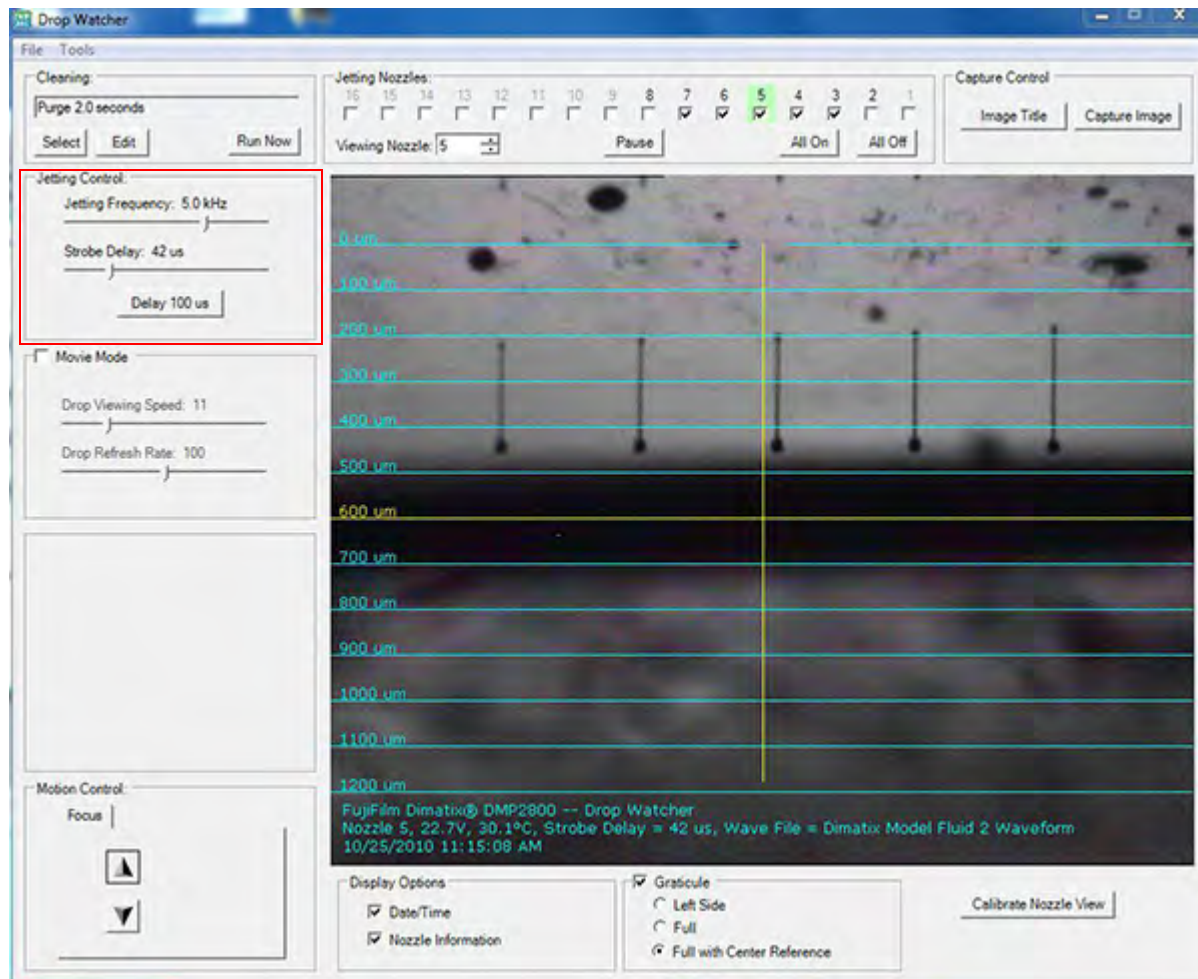

Figure 6 - 11 Jetting Control box

- The **Jetting Control** box allows you to adjust the **Jetting Frequency** while you are jetting. You can then observe the effects by clicking and dragging the bar with your mouse. The minimum frequency is 0.7 kHz.
- The **Strobe Delay** lets you set the time after the drop ejects at which the strobe LED flashes to capture the drop image. This can be adjusted with the slide bar. It has the visual effect of freezing the drop in flight. Clicking on the **Delay 100 μ s** button automatically sets the delay to 100 μ s after drop ejection. When the nozzles are set on the 0 μ m line on the screen with the Graticule on you can read drop velocity easily off the screen. For example, with a 100 μ sec strobe delay you are seeing the drop after it has traveled for 100 μ sec. If the drop is at the 500 μ m line then the drop velocity of these drops is 5 meters per second. This feature should be used to match drop velocities. A good drop velocity to set is between 7 – 9 m/sec.



1.7 Tools Tab

The **Tools** menu for the **Drop Watcher** window lets you select different features.

- **Calibrate Nozzle View** – This feature automatically controls the stage motion to keep the nozzles in line when drop watching regardless of the cartridge angle. To perform this operation follow the following procedure:
 1. Start by clicking on **Calibrate Nozzle View**.
 2. The screen image should be close to nozzle 1. Find nozzle 1 (the right most orifice), put mouse pointer on the nozzle and click-drag it to the cross-hair on the screen. Use the focus buttons as necessary to refine the nozzle's focus.
 3. Click the **Next** button and drag the image to the right until nozzle 16 (the leftmost nozzle) is under the cross hair. Use the focus buttons again as necessary to refine the nozzle's focus.
 4. Click **Next** again and you are done calibrating the nozzle view. Now, when you select any nozzle from one to sixteen, the selected nozzle should be close to the 0 line opening, and in focus.

For the stage to move the selected nozzle into position you must index through the nozzles using the **Viewing Nozzle** box. When you open the drop watcher it tries to center nozzle #8 in the middle of the screen and put nozzle 8 in the **Viewing Nozzle** box. By clicking the cursor in the box it turns the nozzle on and moves it up to the 0 line.

Note: The **Calibrate Nozzle View** feature can also be accessed by clicking the **Calibrate Nozzle View** button in the Drop Watcher main screen.

- **View Cartridge settings** – this allows you to open the cartridge settings form if they were closed.
- **Drop Volume Measurement** - this is a procedure that lets you measure drop volume by using an average drop weight technique.



The following screen shots show the procedure as it appears on the system when you are running it. Once you click **Drop Volume Measurement** the following dialogue box opens up.

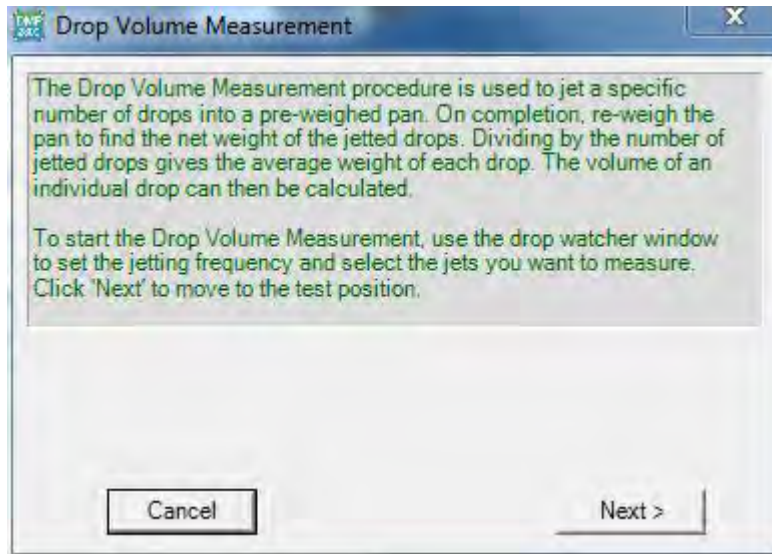

Figure 6 - 12 Drop Volume Measurement

The following dialogue box explains to wait until the carriage moves into position and stops.

Note: Remember that the DMP lid has a safety interlock attached to it. Opening the lid during any system motion causes the system to reinitialize the motors. For this procedure it is important that you open the lid only if the dialogue tells you to.

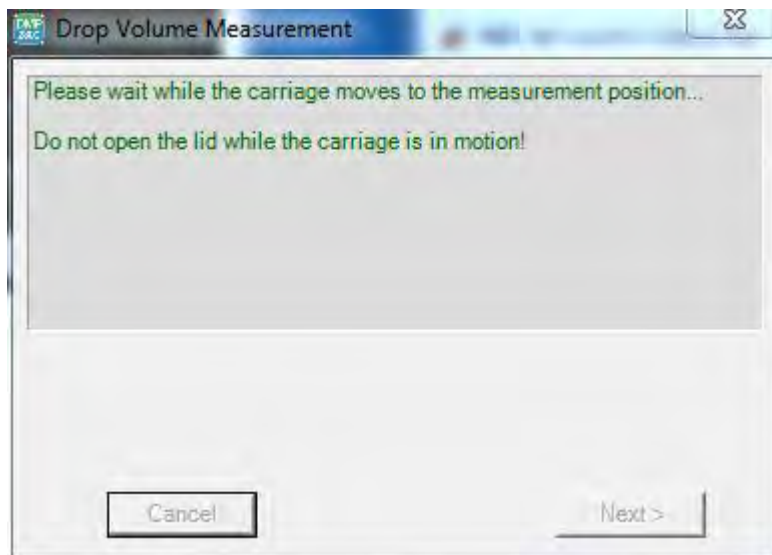

Figure 6 - 13 Drop Volume Measurement screen



When the carriage moves over into position it is about 25 mm above the platen surface.

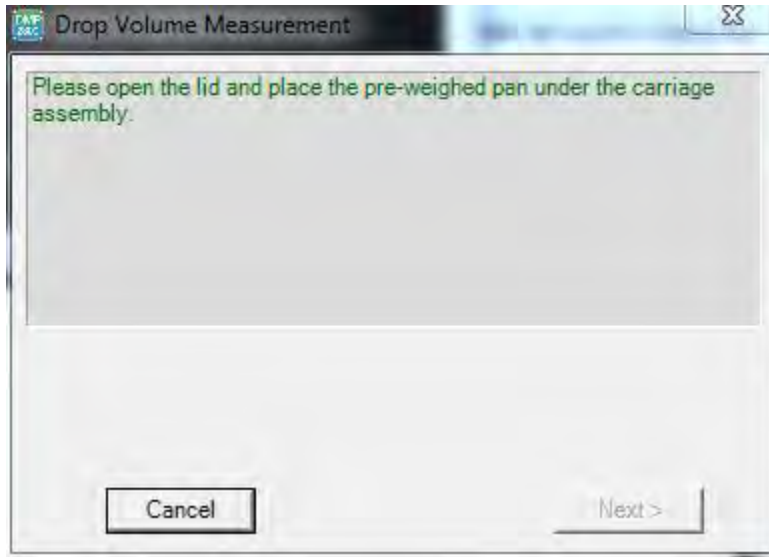

Figure 6 - 14 Drop Measurement screen

To continue you need a container that you have weighed and that fits under the carriage. It is best to use one that is shallow so the carriage can be lowered close to the container (this prevents the loss of drops due to air motion or other influences around the print head).

Adjust the carriage as close as you can to the bottom of the container. This yields more accurate results.

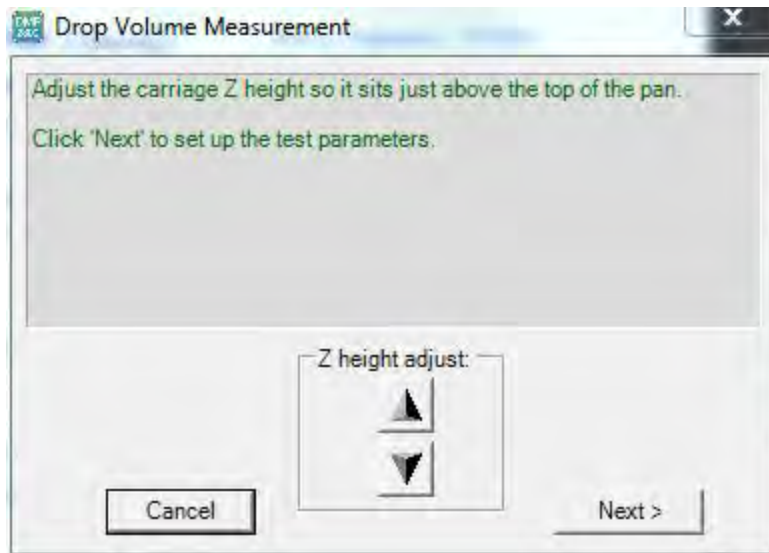

Figure 6 - 15 Drop Volume Measurement screen – Z Height Adjust

You want to weigh as many drops as practical to get the most accurate weight. The number of nozzles you have selected to jet in the drop watcher before opening this menu



shows up on the form. The frequency you set in the Drop Watcher is the jetting frequency for this procedure. The following dialogue box shows that 7 nozzles are selected. The default time period is calculated based on the frequency and number of jets to get close to 1 million drops for then the conversion to the expected drop weight in nanograms gets very easy. Adjust the time to change the number of drops jetted.

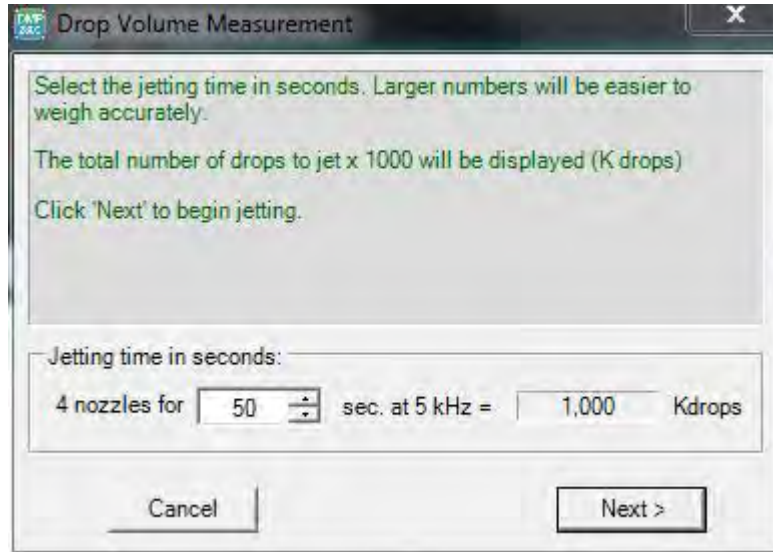

Figure 6 - 16 Drop Volume Measurement screen – Jetting Time

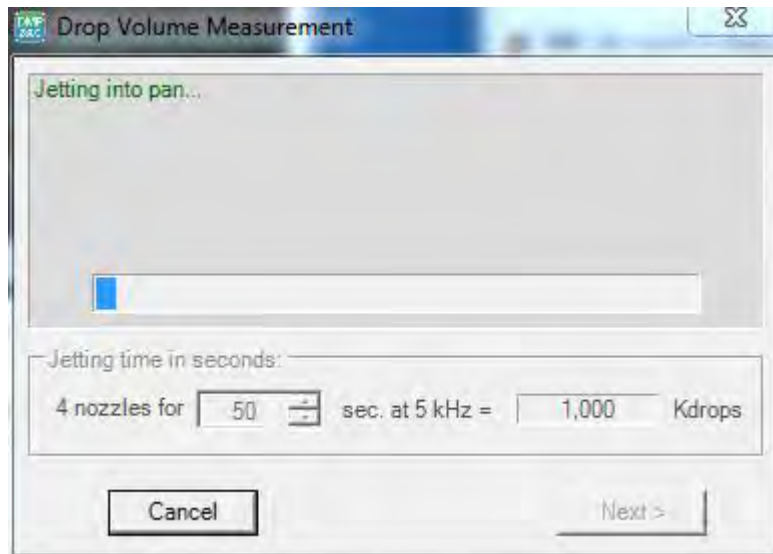

Figure 6 - 17 Drop Volume Measurement screen – Jetting to pan

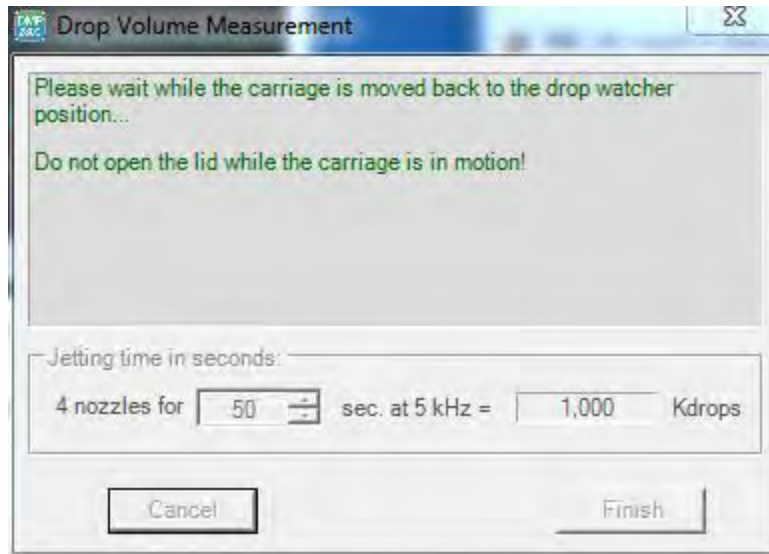

Figure 6 - 18 Drop Volume Measurement – Wait

Once it finishes jetting you are ready to calculate the drop mass after weighing the pan.

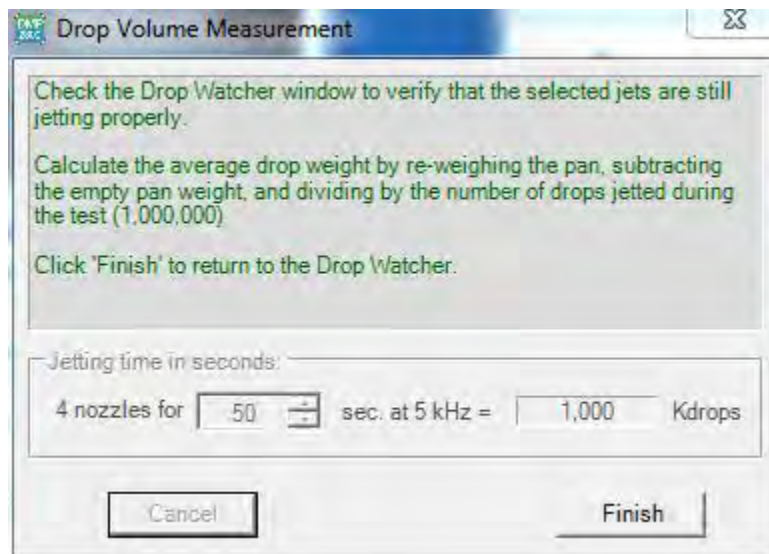

Figure 6 - 19 Drop Volume Measurement – Finish





Fiducial Camera

On the main **DDM** window go into the **Tools** menu and select **Fiducial Functions** or click on the gray **Fiducial Camera** button in the lower left.

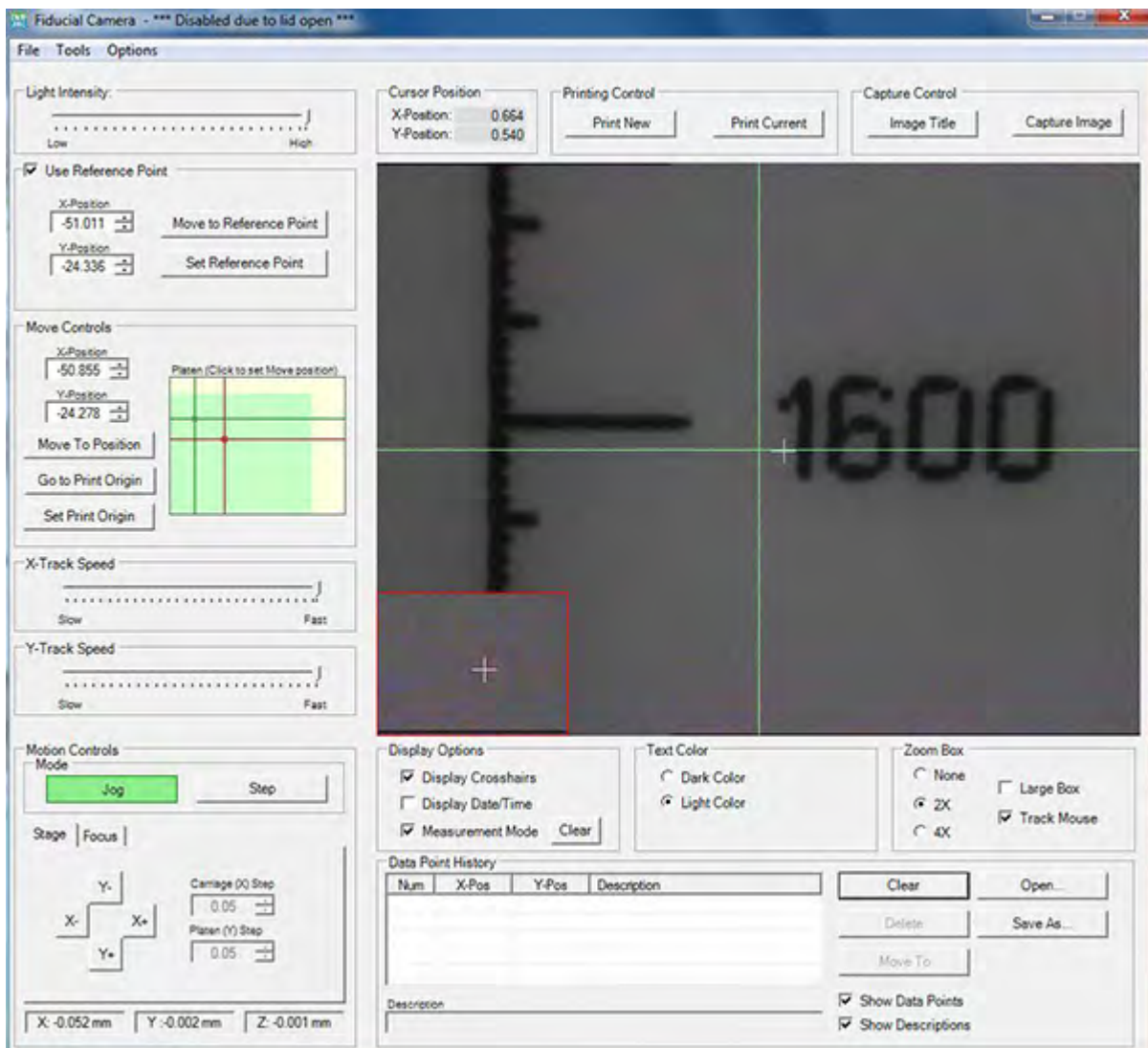

Figure 7 - 1 Fiducial Camera screen



The above image is a sample screen shot of the main **Fiducial Camera** window. The fiducial camera is used when you want to deposit a pattern on a pre-patterned substrate, or if you are jetting a layer with a different cartridge material or to inspect the printed features.

The **Camera Field of View**. This has a width of 1.62 mm and a height of 1.22 mm with a resolution of 2.54 μm per pixel.

The **Fiducial Camera** operates in a **Dark Field** or a **Bright Field** mode. Therefore there are two different light sources the operator can select. The following picture illustrates the hardware switch positions on the camera for the different illumination modes.



Figure 7 - 2 Camera switch for different illumination modes

- Position 1: **Bright Field** mode
- Position 2: both light sources are switched on
- Position 3: **Dark Field** mode

The **Dark Field** mode (switch position 3) allows viewing clear fluids on highly reflective surfaces. It requires very low light intensity only. Move the **Light Intensity** slider almost all the way to the left. In this mode the light source illuminates the sample



in a way that the objective only collects scattered light from the substrate. This results in dark backgrounds with bright objects on top of them. The **Bright Field** mode (switch position 1) works after the same principle as a regular microscope. The light shines on the object and gets directly reflected back into the objective. It requires a high light intensity, so the **Light Intensity** slider has to be moved all the way to the right.

Note: The gain pot located on the top of the camera can be adjusted to one extreme or the other to improve the range of the **Light Intensity** slider for either bright or dark field mode.

1.0 Features

- **Light Intensity** – This slider allows you to adjust the light intensity of the camera to optimize the contrast of the image.
- **Use Reference Point** – By checking this box the DMP positions the pattern's reference point to the **Image Reference Point**. It does this only with the Fiducial Camera window open. If you do not use the reference point, the image is printed from the print origin.
- The position of the **Reference Point** you have selected relative to the selected **Print Origin** is displayed in the **X and Y position text fields**. This is the physical point on the substrate that you want to align a .bmp file for printing.
- **Move to Reference Point** – This button moves the center crosshair to the position of the reference point.
- **Set Reference Point** – This feature lets you select the reference point in the video screen. More detailed instructions for this feature can be found in the *Alignment Procedures* chapter.

Note: A reference point can only be used for imported .bmp images; not for Dimatix Patterns generated with the Pattern Generator. See .bmp printing for more information.



- Move Controls Group
 - **Platen** – The **Beige Area** is the area where the camera can view a feature. The **Green Area** is where you can set a **Print Origin** point. The **Red Crosshair** in the platen box window displays the position of the current print origin. The **Red Box** in this window shows where you are currently viewing on the platen. The **Gray Box** indicates the position of the coordinates that are in the **X-Position** and **Y-Position** boxes. If there is a **Green Box**, it shows you the position of the Image reference point you have selected.
 - **X-Position, Y-Position** – These boxes operate in either of two ways. You can either enter a number into the boxes and then click the **Move To Position** button and the camera moves to that position. Or you can place the cursor in the green area of the **Platen** box and click on a location and then click on the **Move To Position** button and the camera moves to that point and its coordinates are displayed in the boxes.
 - **Go to Print Origin** – Clicking on this button moves the camera back to the Print Origin.
 - **Set Print Origin** – The feature sets the origin of your pattern. Detailed instructions can be found in the **Alignment Procedures** chapter.
- **X-Track Speed** – With this slider button you can adjust the movement speed of the stage in the x axis when aligning and making measurements. This adjustment is done by placing the mouse cursor on the slide and dragging it to the desired speed.
- **Y-Track Speed** – With this slider button you can adjust the movement speed of the stage in the y-axis when aligning and making measurements. This adjustment is done by placing the mouse cursor on the slide and dragging it to the desired speed.
- **Motion Controls** – When the **Jog** button is selected the **Y-, Y+, X-, X+** move buttons can be held down with the mouse and motion only stops when the buttons are released. When the Step button is selected a click on the **Y-, Y+, X-, X+** buttons causes a motion of the stage in the selected direction by one increment. The increment is set in the **Carriage Step** and **Platen Step** text boxes to the right of the **Y-, Y+, X-, X+** motion control buttons.
- **Stage Tab** – The Stage Tab allows movement of the platen and the carriage by using the **Y-, Y+, X-, X+** motion control buttons.
- **Focus Tab** – These two arrows on the **Focus Tab** allow you to focus the camera up or down. The number in the bottom of the **Focus** box is the height in mm from the last set focus origin that the camera is currently focused to. This feature allows you to make Z height measurements. The focused Z height is about 32 mm above the substrate. When using the fiducial camera you can only print on a **maximum substrate thickness of a 25 mm**.



- **Set Focus Origin** – Once you have focused on the relevant height click the Set Focus Origin button. The software stores this value and comes back at this height the next time you open the Fiducial Camera.
- **Set Focus Stop** – This text box sets the step increment that the printer moves the Z-stage when moving in **Step Mode**.
- **Y-, Y+, X-, X+** – These buttons allow you to move the carriage to any position simply by clicking on the button corresponding to the direction you want to go.
- The X, Y, and Z values under the **Motion Control** group display the position of the center crosshair relative to the **Print Origin**.
- **Cursor X-Position, Cursor Y- Position** – This box displays the position of the cursor relative to the print origin in either the displayed image or in the **Platen** box.
- Printing Control
 - **Print New** – This button lets you choose a print pattern from your hard drive.
 - **Print Current** – This button starts printing the pattern currently loaded in the DDM window.
- **Capture Control** – This box allows you to capture the displayed image similar to the drop watcher image capture feature.
 - **Image Title** – Click on this to open the box as seen below to type in a name for your image.

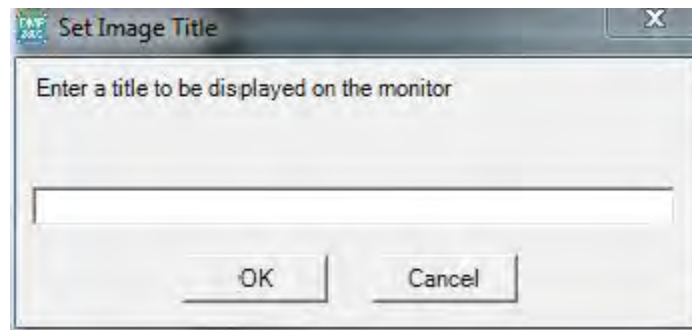

Figure 7 - 3 Set Video Title screen

- **Capture Image** – Click on this to save the image in a file of your designation.
- **Display Options** – This feature lets you toggle on and off the green **Center Crosshair**, choose to **Display Time and Date** in the video screen, and choose to work in either the **Measurement Mode** or the **Data Point History Mode**.
- **Text Color** – This feature lets you toggle dark and light text color for all information displayed in the video screen.
- **Zoom Box** – Lets you activate and configure the zoom box settings.



- **Data Point History** – This box allows you to select any points in your pattern and save them in a file for future reference or for analysis in an Excel spreadsheet. Simply place the cursor on the point you wish to capture and click on it. The X and Y position go into the table. If you click on the line of data in the table you can then enter a description of that point. By clicking on the **Show Data Points** or **Show Description** boxes you can turn those on or off.

2.0 Alignment Procedures

For the printer to print accurately to a defined position you have to perform a series of alignments before starting your print job. These alignment procedures can either be initiated from the **Tools** menu or the **Fiducial Camera** main screen.

Print Origin and Reference Point – These two features compensate for the X and Y translative error that one makes when placing a substrate by hand on to the platen. They are set by using either the **Use Reference Point** group or by using the **Set Print Origin** feature on the Fiducial Camera main screen. They are exclusive, meaning that you can only print relative to the print origin or relative to the reference point. However, you can set both at the same time. Depending on how you start your print job the printer either prints relative to the print origin or the reference point.

- **Pattern files** (PTN files) can be printed only relative to the Print Origin.
- **Converted .bmp files** (PTF files) can be printed by either coordinate system. If you have the Use Reference Point check box activated and you have defined a reference point in the PTF file and you start your print job from the Fiducial Camera, you print relative to the reference point.
- If you print from the **DDM** window, you print relative to the Print Origin.
- If you have NOT set a reference point in the image file or the Use Reference Point check box in the **Fiducial Camera** screen is not checked, then you print relative to the Print Origin.



2.1 Setting the Print Origin

When you click on Set Print Origin the following window displays.

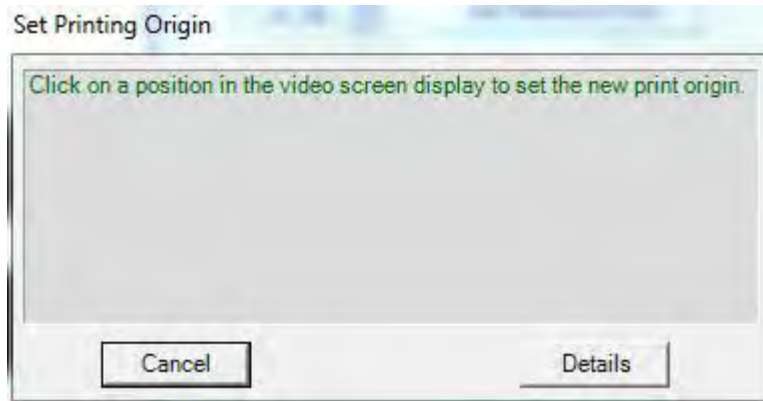

Figure 7 - 4 Set Print Origin screens 1 of 2

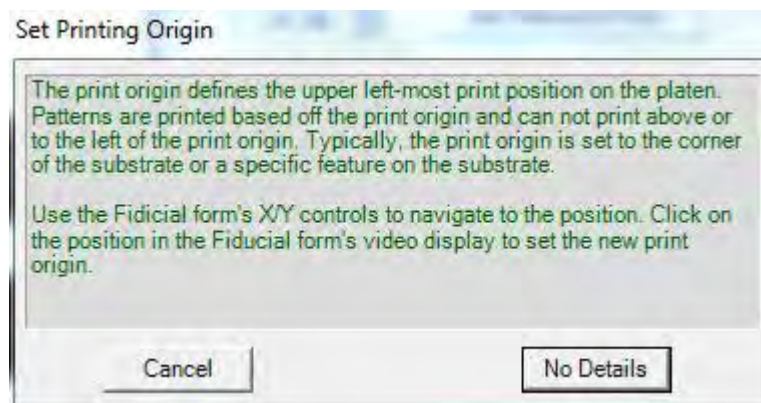

Figure 7 - 5 Set Print Origin screens 2 of 2

With the fiducial camera open, move the camera to the point you want to be the origin. Place the cursor on the image and click on the point you want for the origin. That becomes the origin from which other measurements are made and from which the pattern originates. When you click on your point, the crosshairs and camera center on that point. You cannot set an origin on the lines scribed in the platen.

Note: The location which allows you the largest printing area is about 7 mm down from the X line and about 4 mm to the left of the Y line.

Trying to set the print origin exactly to the inscribed 0,0 corner leads to an error message.



2.2 Setting the Reference Point

Set the Reference Point is used to set the physical reference point for an **Image Reference Point** you have selected. The image is aligned so that its reference point is printed at this location on your substrate.

When you click on the Set Reference Point, the following window displays.

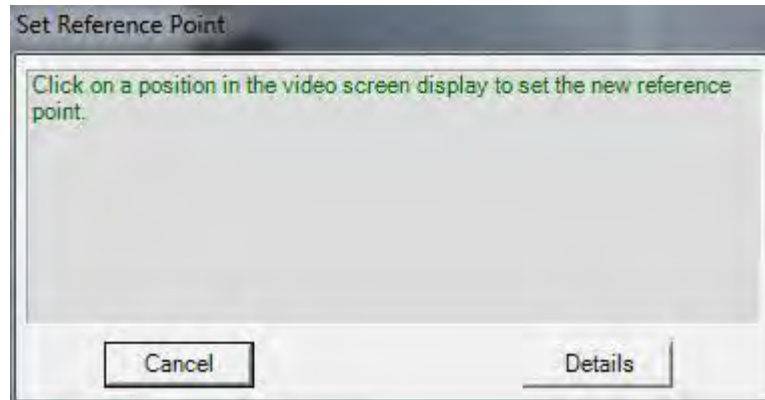

Figure 7 - 6 Set Reference Point screens 1 of 2

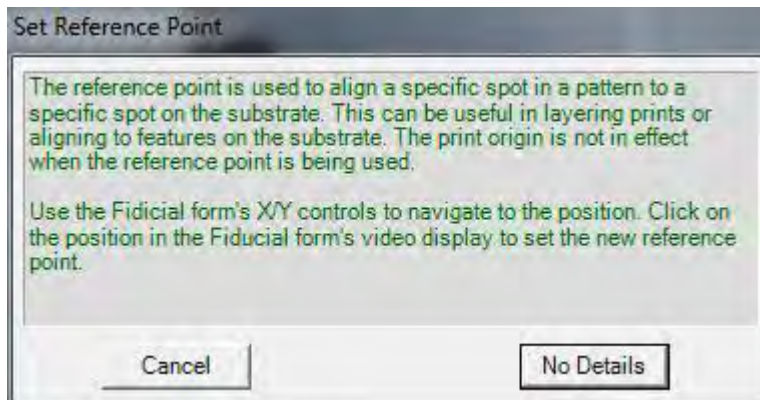

Figure 7 - 7 Set Reference Point screens 2 of 2

Setting a reference point is similar to the procedure you used for setting **Print Origin**.

1. Move to the position on the substrate you want to use.
2. Place the cursor on that point on the view image and right click.
3. Use the up/down arrow buttons in the reference points X-Position and Y-Position boxes to adjust the point.

Note: You must check the **Use Reference Point** box on the Fiducial Camera window and you must leave the camera window open to print the image using the reference point.



Drop Offset – Drop Offset compensates for the error between the point that the fiducial camera is looking at and the position that the cartridge is actually printing to. This offset is set in the Fiducial Camera **Tools** menu. Detailed instructions can be found in the **Tools** Menu in the *Fiducial Camera Window* chapter.

Calibrate Theta – This feature compensates for the angular error the operator introduces when placing a substrate into the printer by hand. This offset is set in the Fiducial Camera **Tools** menu. Detailed instructions can be found in the **Tools** Menu in the *Fiducial Camera Window* chapter.

The following set of actions have to be performed in the exact sequence in order to print to a defined location on the substrate.

1. If any of the following conditions have occurred:
 1. head angle changed manually by operator
 2. cartridge was replaced
 3. nozzle count has changed
 4. start nozzle was changed

then the head angle as to be recalibrated and the drop offset procedure has to be executed.

2. If the substrate was moved by the operator, then first execute the **Calibrate Theta** function. Then run either the **Print Origin** or the **Reference Point** function

2.3 Tools Menu in the Fiducial Camera Window

- **Set Drop Offset** – This feature is used to calibrate the position of a new or different cartridge to the previous printed pattern.

Note: This procedure is very important and always has to be done when a cartridge has been changed or the saber angle was adjusted and you want to print exactly to a defined spot on your substrate.

- In an area outside your printing area of concern, a pattern is jetted where you can locate one single drop. The pattern is printed with the nozzles you have selected, the cartridge settings you are using, and the resolution of your last used print pattern. It consists of a 10 mm line in X direction with a single dot 1 mm to the right of it.

When you click on **Set Drop Offset** in the **Tools** menu the following window pops up.



To start you must have the cartridge set to the angle required by your pattern. At the first screen click **Next**.

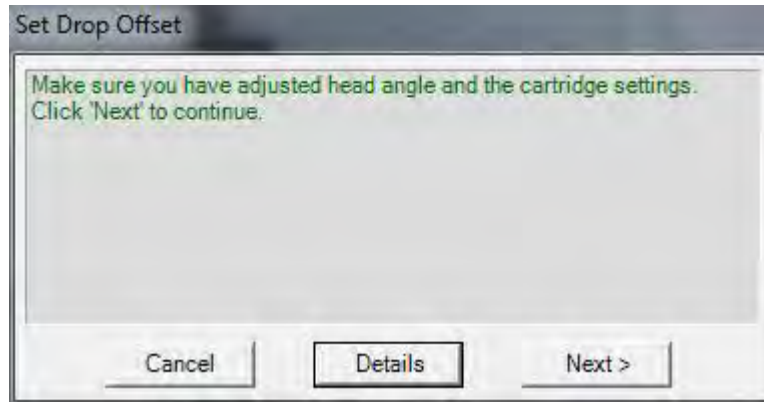

Figure 7 - 8 Set Drop Offset screen 1 of 7

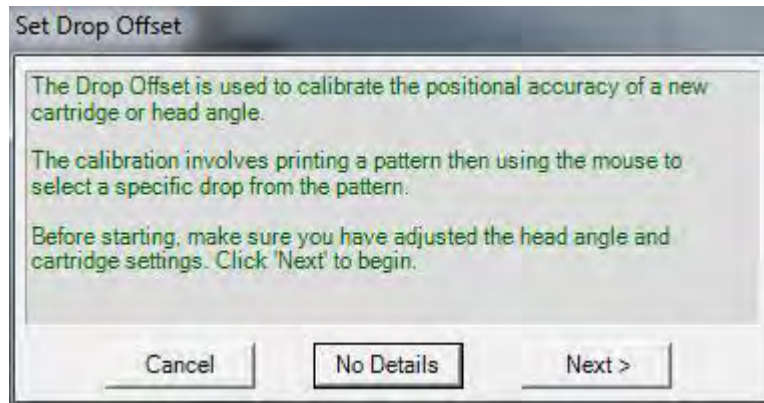

Figure 7 - 9 Set Drop Offset screen 2 of 7

Move to a position where you can print the test pattern and place the cursor on the screen and click in the fiducial camera screen to select the print location.

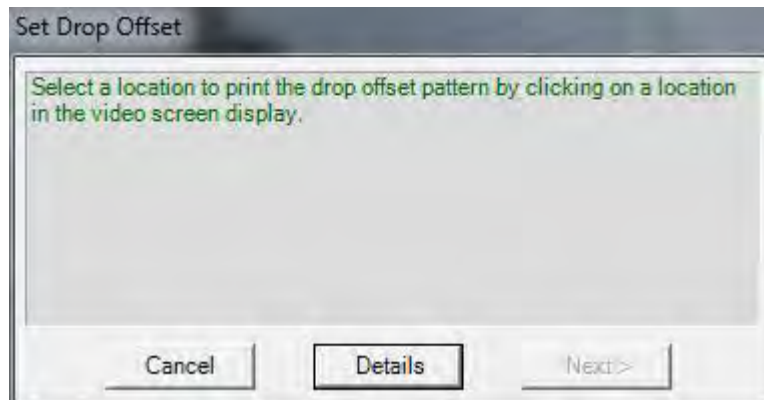

Figure 7 - 10 Set Drop Offset 3 of 7

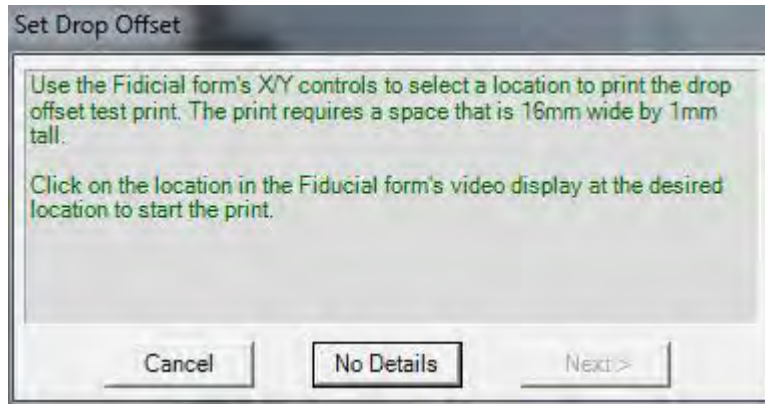

Figure 7 - 11 Set Drop Offset 4 of 7

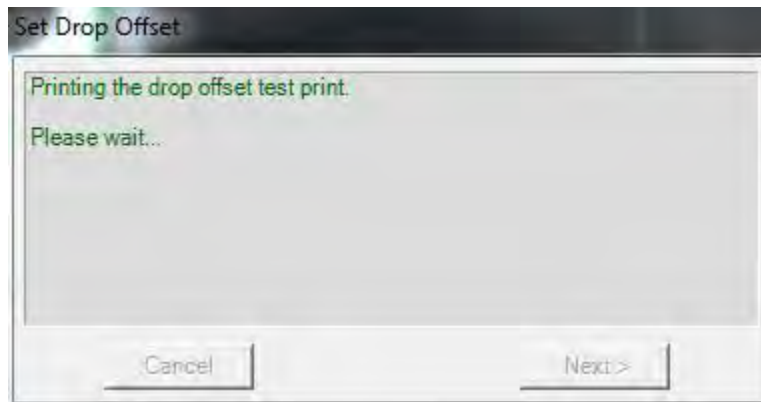

Figure 7 - 12 Set Drop Offset 5 of 7

After the test pattern has been printed locate first the line then the single spot and click on its center.

Note: The fiducial camera usually comes to a point somewhere below the line so you only have to move in negative y direction to find the line.

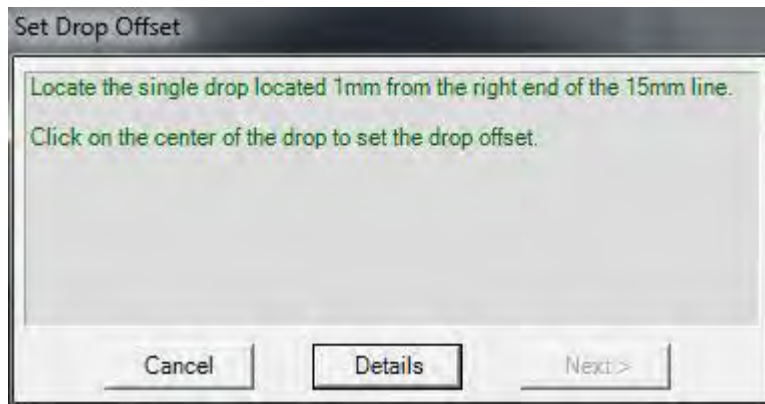

Figure 7 - 13 Set Drop Offset 6 of 7

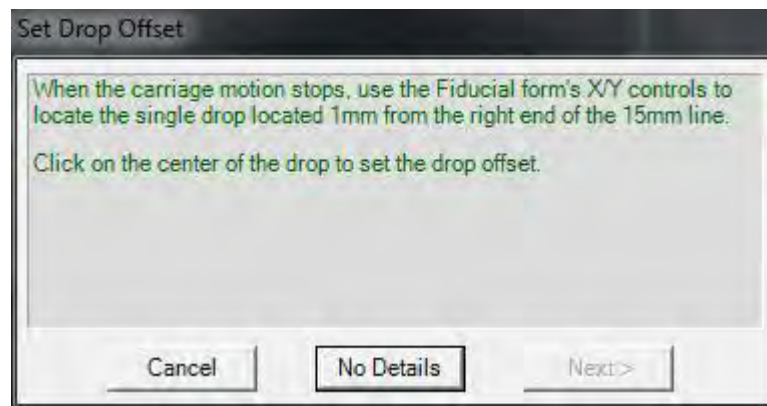

Figure 7 - 14 Set Drop Offset 7 of 7

It should look similar to the following image.

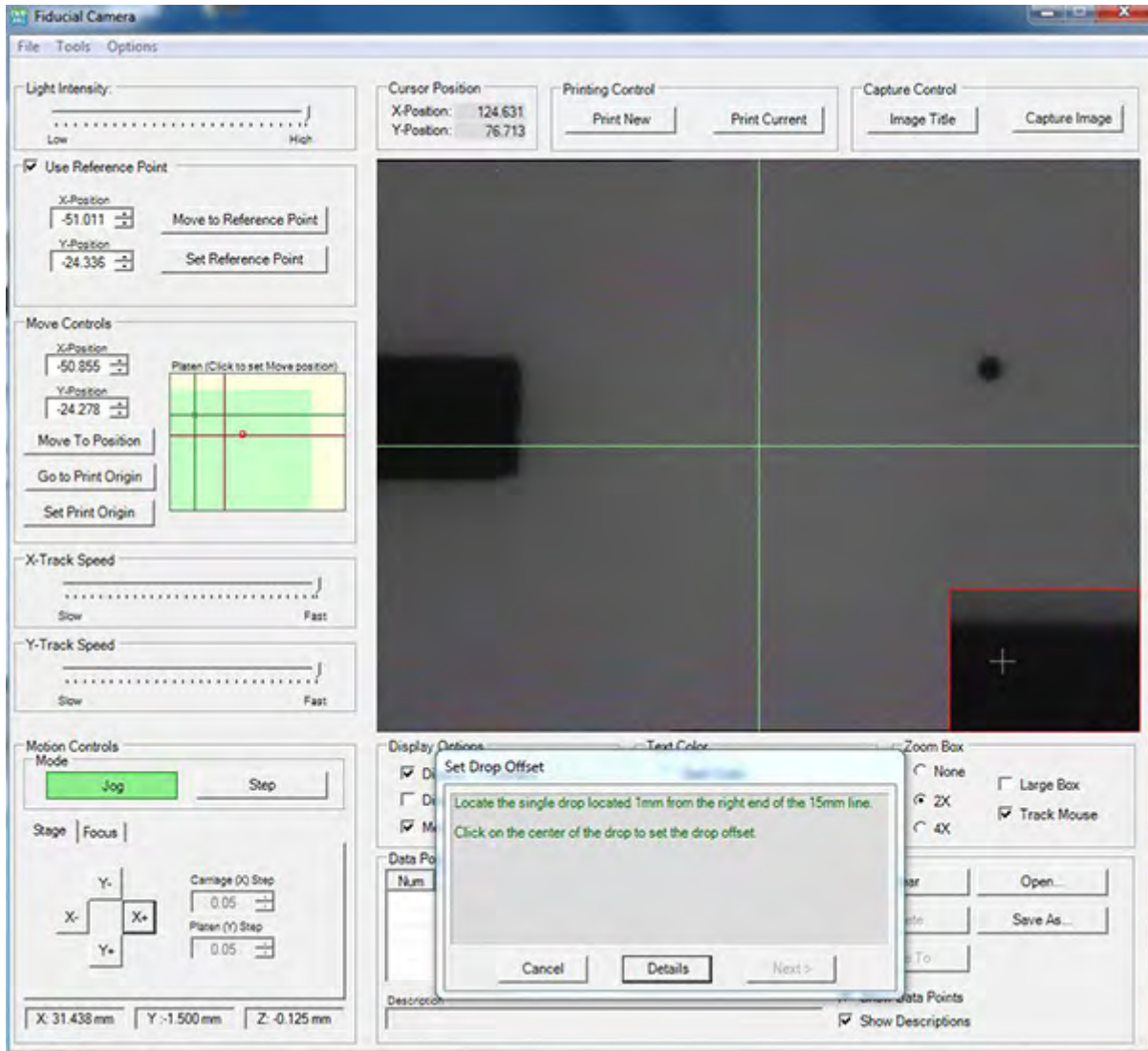

Figure 7 - 15 Fiducial Camera screen



This routine is now completed. Click the **Finish** button.

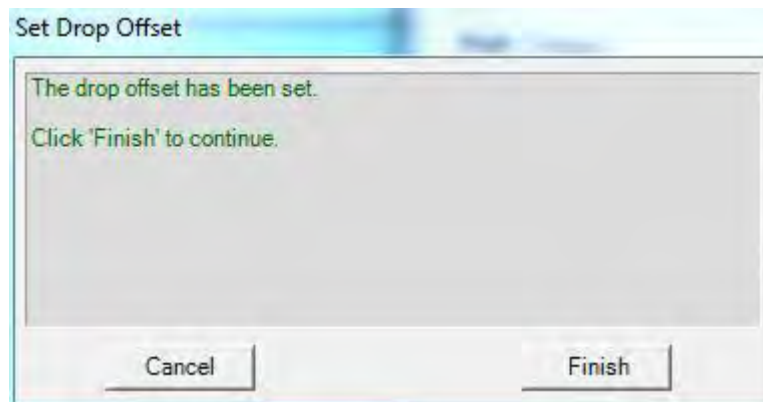

Figure 7 - 16 Set Drop Offset – Procedure Finish screen

If the drop offset is determined to be outside the normal range, it needs to be repeated after verifying that the first nozzle selected in the cartridge settings is jetting properly and that the cartridge is positioned well in the holder.

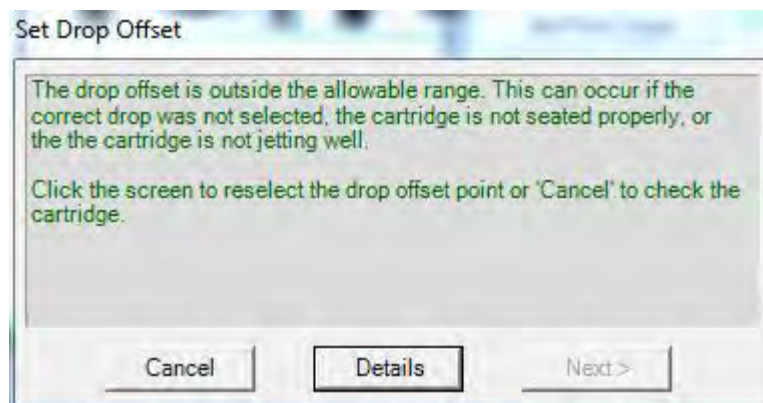

Figure 7 - 17 Drop Offset – Outside of Allowable range

This has now adjusted any positional offset from the newly installed cartridge to fiducial camera which you set the origins and reference points with.

- **Set Drop Offset (Manual)** – This is used to calibrate a new or different cartridge by creating your own pattern. This may be useful when jetting clear or difficult to see fluids.
 - In an area outside your printing area of concern, jet a pattern where you can locate one drop. This can be a single drop pattern (which may be difficult to find or see) or maybe a square of 5 drops (X and Y) or a + pattern that you can find with the camera.



- When you click on **Set Drop Offset** in the **Tools** menu the following window pops up.

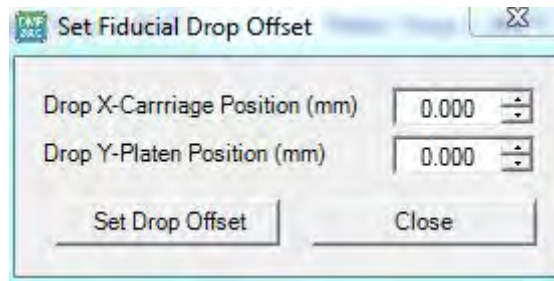

Figure 7 - 18 Set Fiducial Offset

- Enter the position of the dot you specified as the upper left dot in your pattern file.
- Click on the **Set Drop Offset** button and the following window pops up.

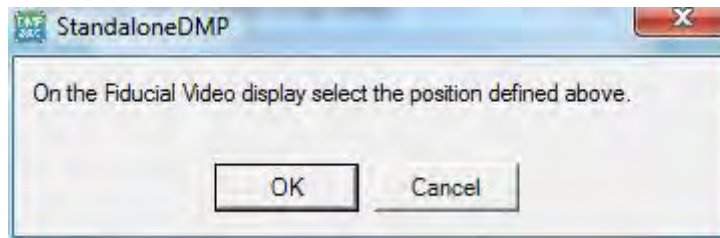

Figure 7 - 19 Fiducial Video Display – select position

- Click **OK**.
- Then place the cursor on the center of the drop in the pattern that you just jetted and click.
- This has now adjusted any positional offset from the cartridge to what the pattern file specifies.
- **Calibrate Theta** – This feature allows you to compensate for an angular offset that you might have on the substrate or pattern that you have placed on the platen.



To calibrate:

- Click on the feature in the **Tools** menu and the following window pops up.

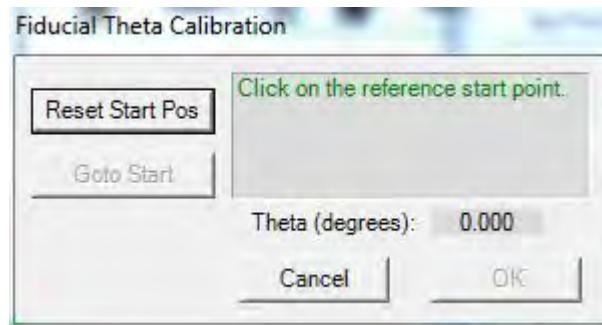

Figure 7 - 20 Theta Calibration – Reference Start Point

- Click on the first point you want to use on the fiducial camera image. The following screen then pops up:

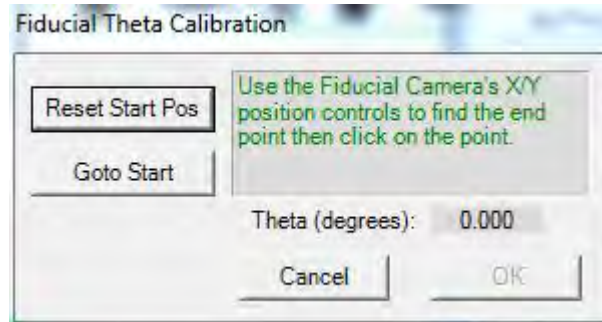

Figure 7 - 21 Theta Calibration – Find Endpoint

- Move to the next spot you want to use for Theta calibration by using the **X+**, **X-**, **Y+**, or **Y-** buttons on the **Fiducial Camera** window. If you are using a point far from your current position you may also jump there by pointing to it in the green area of the **Platen** in the **Move Controls** box on the **Fiducial Camera** window and clicking the **Move** button. You may also enter the coordinates in the **Move Controls** box and click **move**.
- After clicking on the second point the following window pops up. Click **OK**.



Figure 7 - 22 Theta Calibration – Set points



- **Calibrate Thermal Scaling** – This feature allows you to compensate for a substrate that has changed dimensions during a thermal process after printing, and you want to print on it again, or that changes dimensions significantly if heated while on the platen.

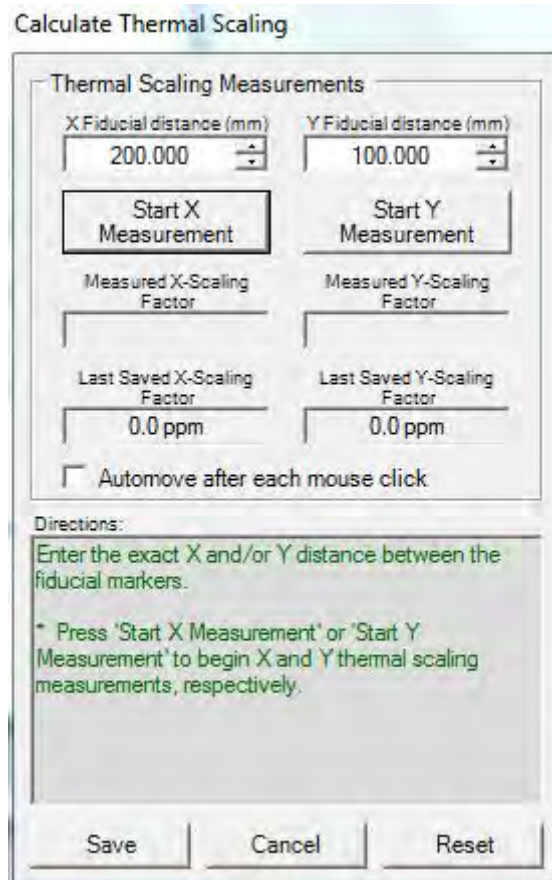

Figure 7 - 23 Calibrate Thermal Scaling



- Start by entering the distance between your two fiducial marks on the substrate that you are going to use for the calibration.
- Locate your first fiducial mark with the fiducial camera.
- Click on the **Start X Measurement** (or Y if you have only Y direction marks).
- Click on your fiducial mark. The button turns green and says **Cancel** if you want to cancel and start over.

Calculate Thermal Scaling

Thermal Scaling Measurements

X Fiducial distance (mm)	Y Fiducial distance (mm)
200.000	100.000
Cancel X Measurement	Start Y Measurement
Measured X-Scaling Factor	Measured Y-Scaling Factor
Last Saved X-Scaling Factor	Last Saved Y-Scaling Factor
0.0 ppm	0.0 ppm

Automove after each mouse click

Directions:

On the Fiducial Display move to the starting X fiducial marker and click on it with the mouse.

* Check 'Automove...' for automatic movement to expected second fiducial marker.

Save Cancel Reset

Figure 7 - 24 Calculate Thermal Scaling – Cancel X Measurement

- With the **Automove** box checked the fiducial camera automatically moves in



the direction you are calibrating the distance entered in the box.

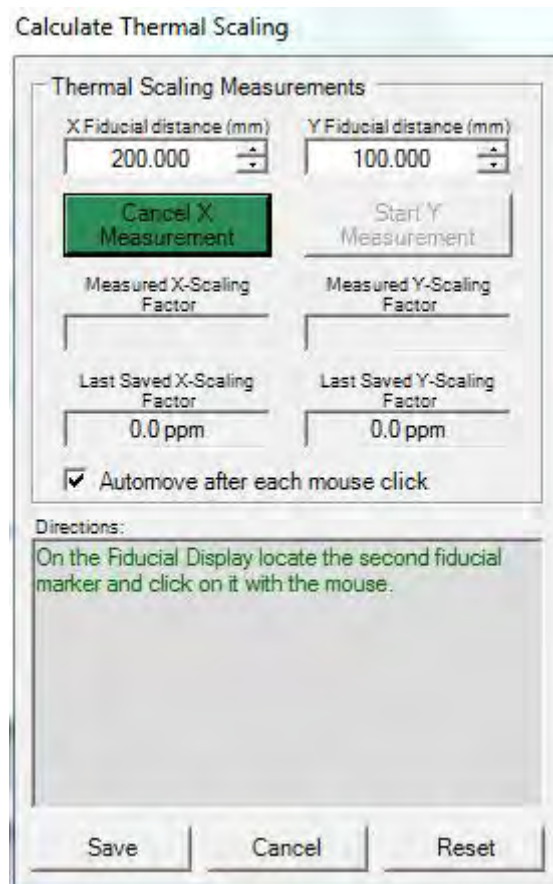

Figure 7 - 25 Calculate Thermal Scaling – Locate second marker

- When the camera stops at the indicated position, place the cursor on the second mark and left click the mouse. If you don't see the feature in the image area move the camera with the x & y motion controls to locate it.
- Now you want to repeat the procedure for the other axis (Y or X) if you have



fiducial marks for that axis.

Calculate Thermal Scaling

Thermal Scaling Measurements

X Fiducial distance (mm)	Y Fiducial distance (mm)
200.000	100.000
<input type="button" value="Cancel X Measurement"/>	<input type="button" value="Start Y Measurement"/>
Measured X-Scaling Factor	Measured Y-Scaling Factor
Last Saved X-Scaling Factor	Last Saved Y-Scaling Factor
0.0 ppm	0.0 ppm
<input checked="" type="checkbox"/> Automove after each mouse click	

Directions:

On the Fiducial Display locate the second fiducial marker and click on it with the mouse.

<input type="button" value="Save"/>	<input type="button" value="Cancel"/>	<input type="button" value="Reset"/>
-------------------------------------	---------------------------------------	--------------------------------------

Figure 7 - 26 Calculate Thermal Scaling – enter distances

- When you have completed the calibration click the **Save** button and you are ready to jet your pattern that is corrected to the new size of your substrate.

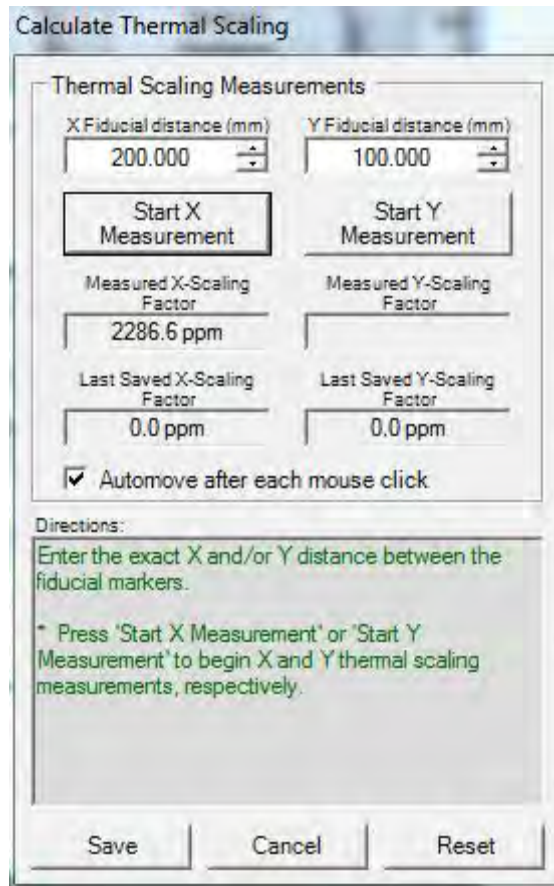

Figure 7 - 27 Calculate Thermal Scaling – Scaling factors computed

Note: The reset button restores the default values of the DMP. A software and printer restart does the same.

- **Measure Cartridge Angle** – Occasionally you may experience gaps in your printed image. This may be a result of not setting the cartridge angle precisely enough and it may need adjusting. This is the procedure to tell you how much you are off and which way to correct it.
 - In the Fiducial Camera window **Tool menu** select **Measure Cartridge Angle**. Then follow the instructions in the window.

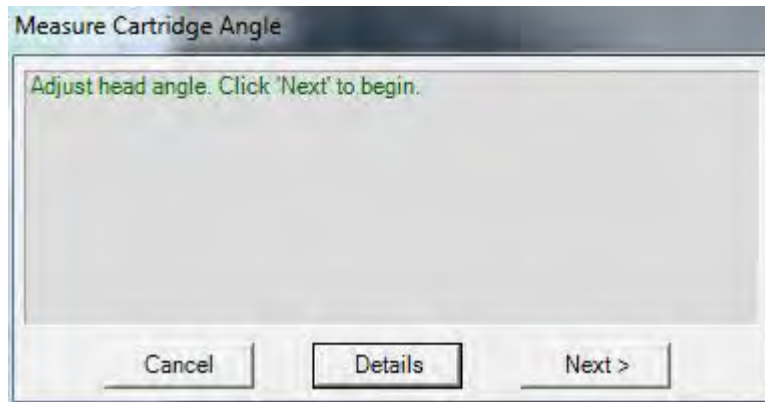

Figure 7 - 28 Measure Cartridge Angle 1 of 7

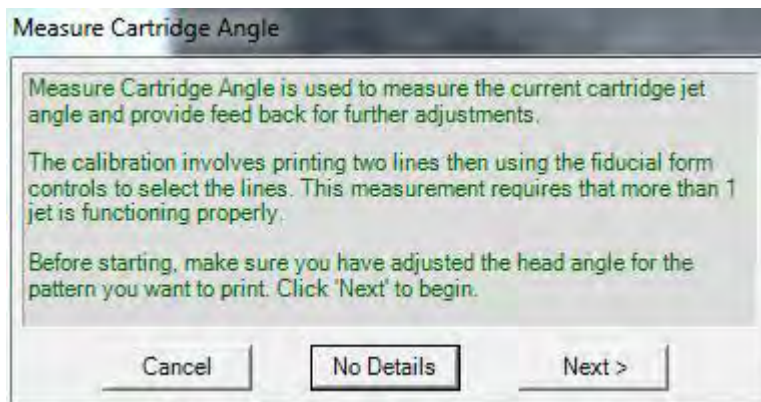

Figure 7 - 29 Measure Cartridge Angle 2 of 7

This feature uses the outer most nozzles selected in the **Cartridge Settings** file.

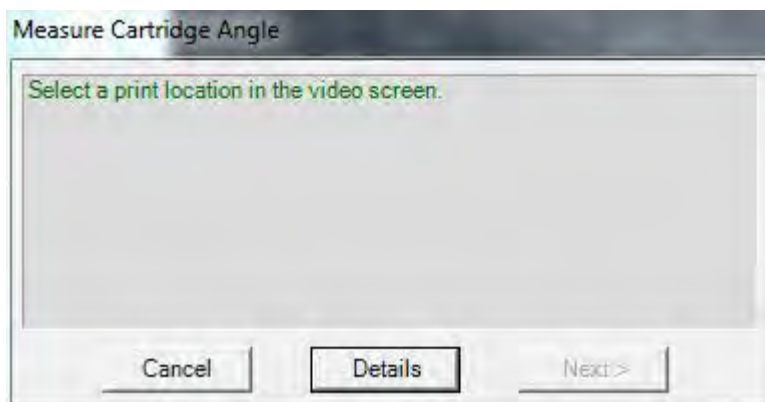

Figure 7 - 30 Measure Cartridge Angle 3 of 7

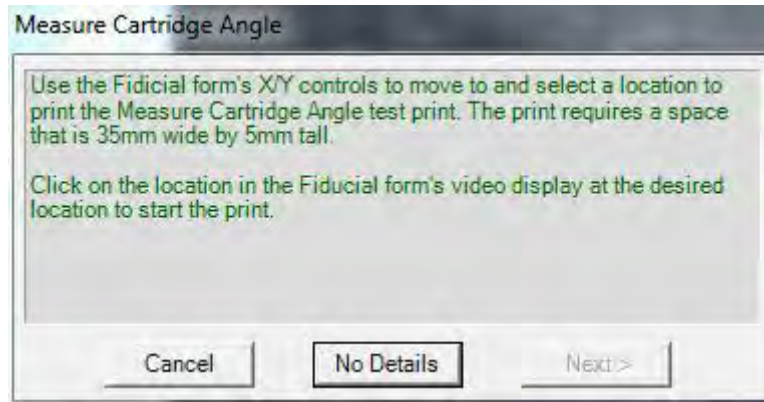

Figure 7 - 31 Measure Cartridge Angle 4 of 7

Move to a space where you can print the pattern or place a different substrate on the platen and place the cursor on the starting point on the screen and click on it. The system then prints the test pattern.

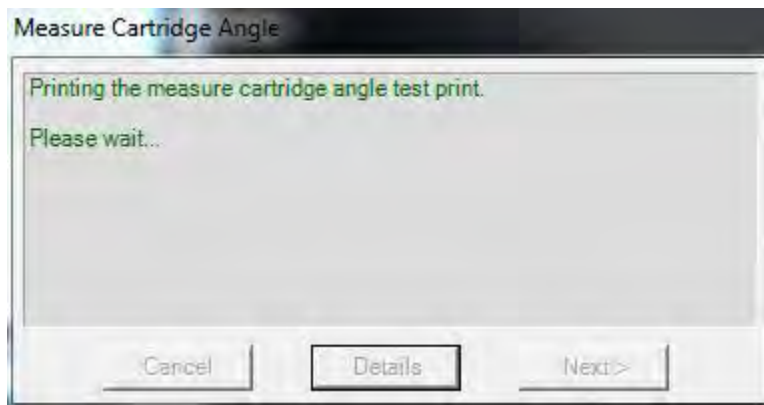

Figure 7 - 32 Measure Cartridge Angle 5 of 7



With the X,Y motion controls, place the cross hairs on the center of the top line, click the next box, move to the bottom line, center the cross hairs on it and click the next box.

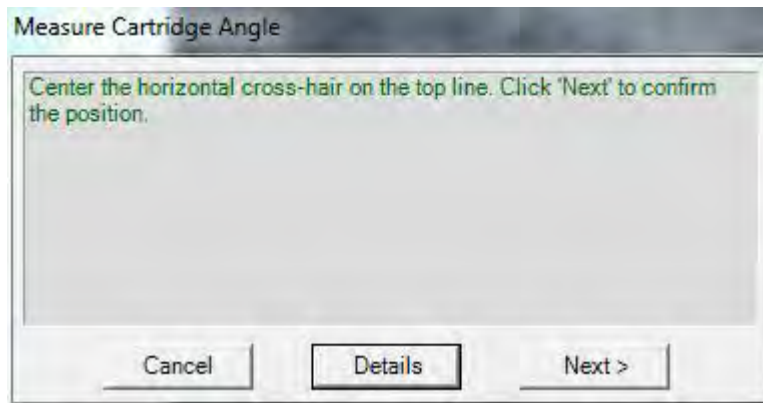

Figure 7 - 33 Measure Cartridge Angle 6 of 7

The following window is an example of the results from measuring the jet angle. It tells you the direction and how much to adjust the head to get better printing.

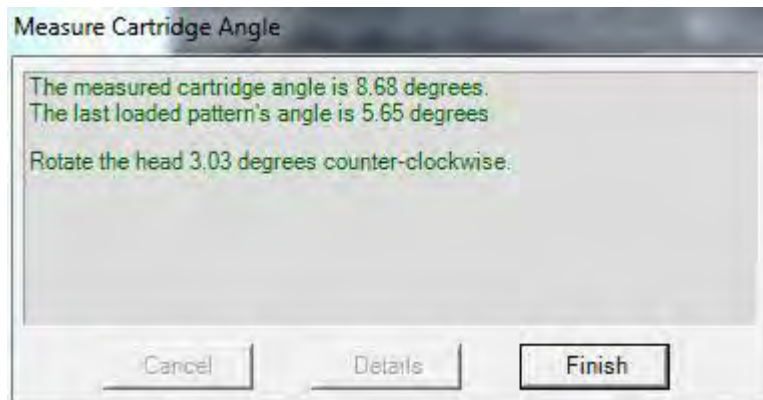

Figure 7 - 34 Measure Cartridge Angle 7 of 7

Click **Finish** when you are done.

Configure – The configuration should be as shown in the window below. The Dazzle device should be selected if your system was delivered with one. If you have an internal video card, select the Hauppauge card.



Configure Video Camera Input – This option lets you set the video setting for the fiducial camera. The configuration should be set to the values as shown in the window below.

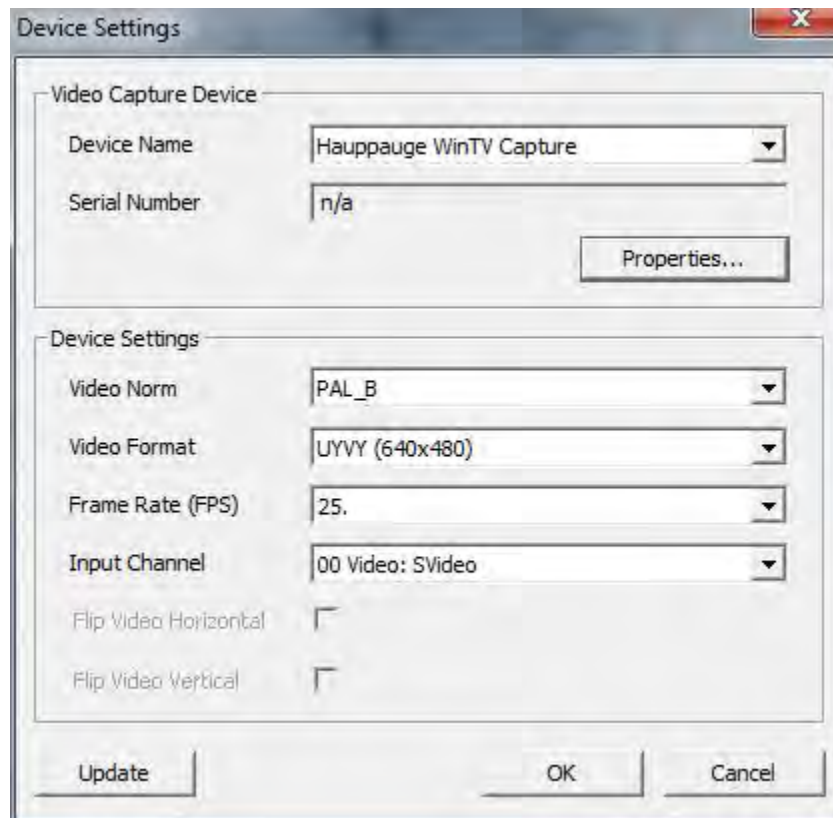

Figure 7 - 35 Video Controller Screen

2.3.1 Options menu in the Fiducial Camera Window

- **Platen Vacuum** – Here you can switch on and off the platen vacuum without having to go back to the main menu.

File menu in the **Fiducial Camera** window

- **Print New Pattern** – This feature allows you to select a new print pattern while in the fiducial mode.
- **Print Current Pattern** – This feature lets you print the pattern selected on the main DDM window while in the fiducial mode.
- **Exit** – Clicking on this allows you to exit the **Fiducial Camera** window.





Fluid Requirements

Some of the fluid physical characteristics to achieve optimum performance are:

- **Viscosity** – 10-12 centipoise at jetting temperature
- **Surface Tension** – 28-42 dynes/cm at jetting temperature
- **Low Volatility** – Boiling points higher than 100° C are preferred
- **Density** – Specific gravity greater than 1 is beneficial
- **Degassing** – Additionally the fluid may need to be degassed to remove any dissolved gas which inhibits jetting. Typical degassing can be done with a vacuum (a negative pressure of 2 psi for 1-2 hours maybe sufficient or up to only 50mbar), by using ultrasonic, or by spinning (fully miscible solutions only).
- **Filtration** – If particle size allows, it is recommended to filter all fluids to 0.2µm.
- **Acidity or Alkalinity** – A pH-value between 4 and 9 is recommended.

Refer to FUJIFILM Dimatix Application Notes in the Tech Support link at the bottom of the FUJIFILM Dimatix home page (www.dimatix.com) for more information.

1.0 Dimatix Model Fluid

This fluid is a non-toxic, non-hazardous, non-drying fluid used to test and qualify the printheads.

- The **surface tension** is 28 - 42 dynes/cm at jetting temperature. A polymeric dye was selected to color the fluid.
- The jetting temperature for Model Fluid is 35° C, resulting in a typical **viscosity** of 11.2 to 11.7 centipoise.



2.0 Drop Formation

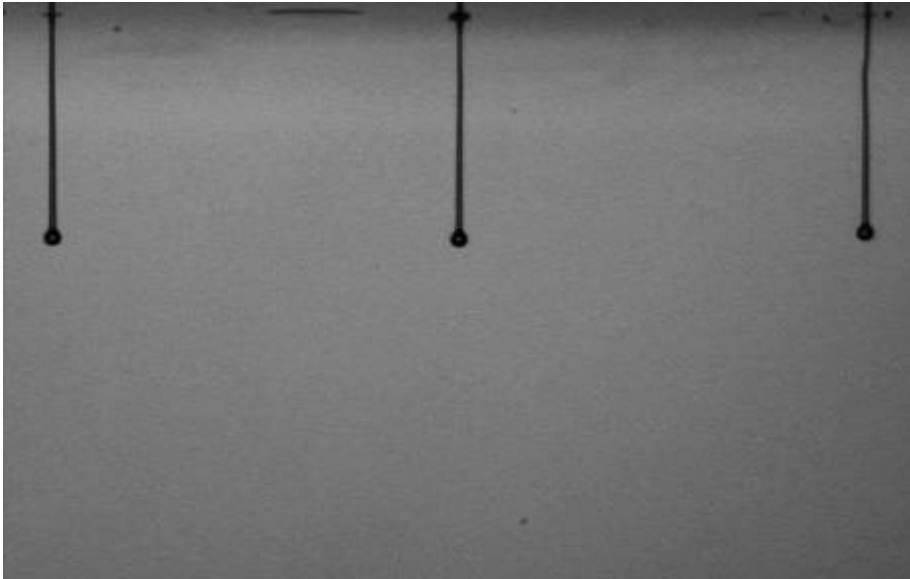

Figure 8 - 1 Waveform: wc_test.csv Voltage: 31 V

The following screen is a typical single pulse waveform such as one used for the Dimatix Model Fluid.

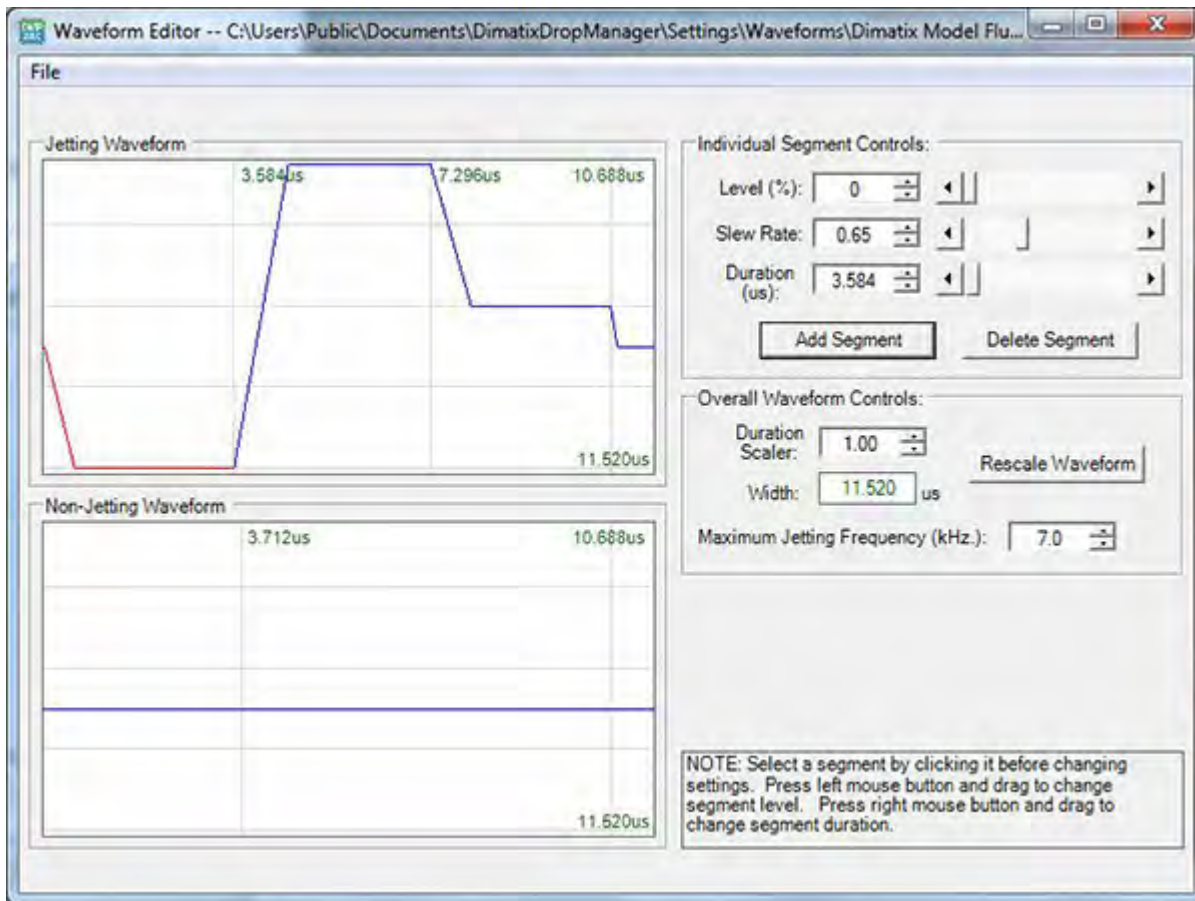

Figure 8 - 2 Single Pulse Waveform



The following picture shows a captured frame of a video taken during the testing of Dimatix Model Fluid. You can see that after the drop leaves the nozzle it has a ligament. The liquid, on this small scale, is mostly influenced by cohesive forces within the fluid. Here not all of the ligament collects into the main drop again, creating a satellite, which is a small drop of ink following or in close proximity of the main drop. Switching to lower voltage leads to smaller ligaments. You could reduce the frequency, change the waveform, or a combination of these to get your desired drop formation. These drops were jetted with 25V.

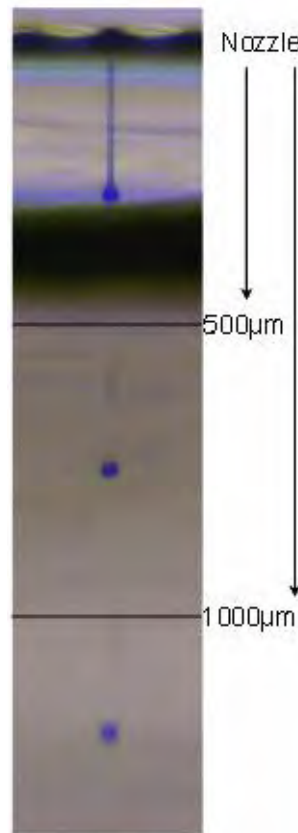

Figure 8 - 3 Capture frame

Refer to FUJIFILM Dimatix Application Notes in the Tech Support link at the bottom of the FUJIFILM Dimatix home page (www.dimatix.com) for more information on drop tuning.

3.0 Performance

The following are typical jetting results that the user may get from jettable fluids.



3.1 Drop Velocity vs. Frequency

Higher viscosity fluids have lower velocity and a better high frequency performance due to their dampening effect.

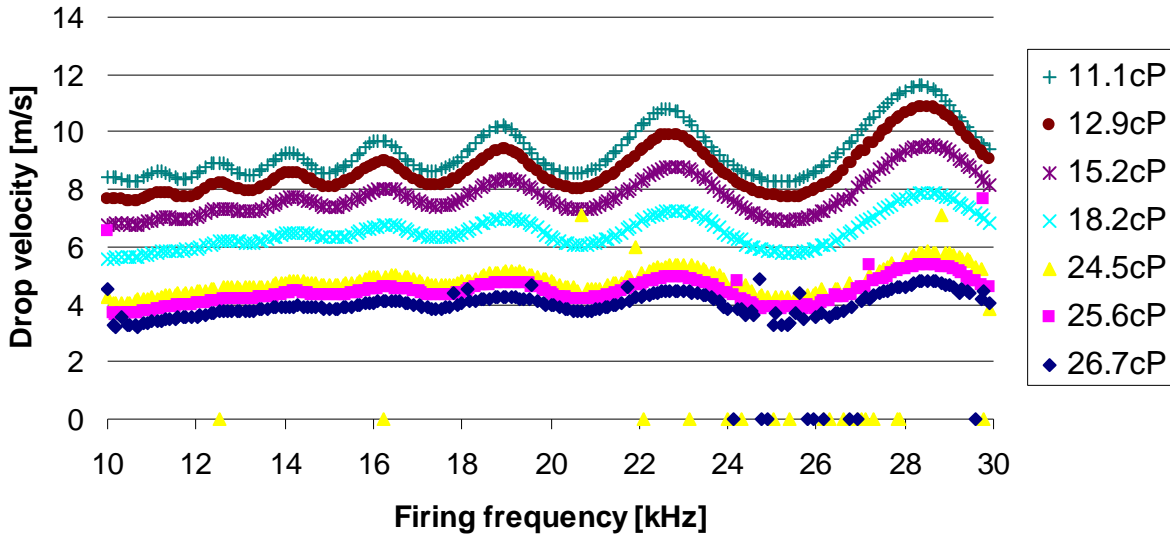

Figure 8 - 4 Drop Velocity vs. Jetting Frequency

3.2 Drop Velocity vs. Voltage with different Viscosities

To maintain a given drop velocity, higher jetting voltages are required for higher viscose fluids.

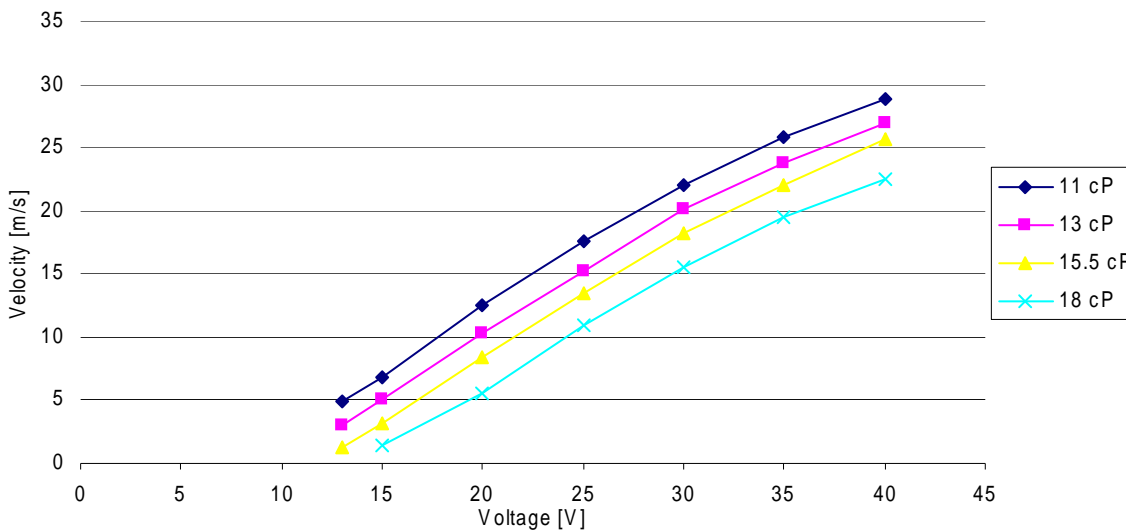

Figure 8 - 5 Velocity vs. Voltage



3.3 Voltage vs. Drop Mass

The following chart shows that jetting at higher voltages leads to faster drops. Jetting at higher voltages also leads to bigger drops.

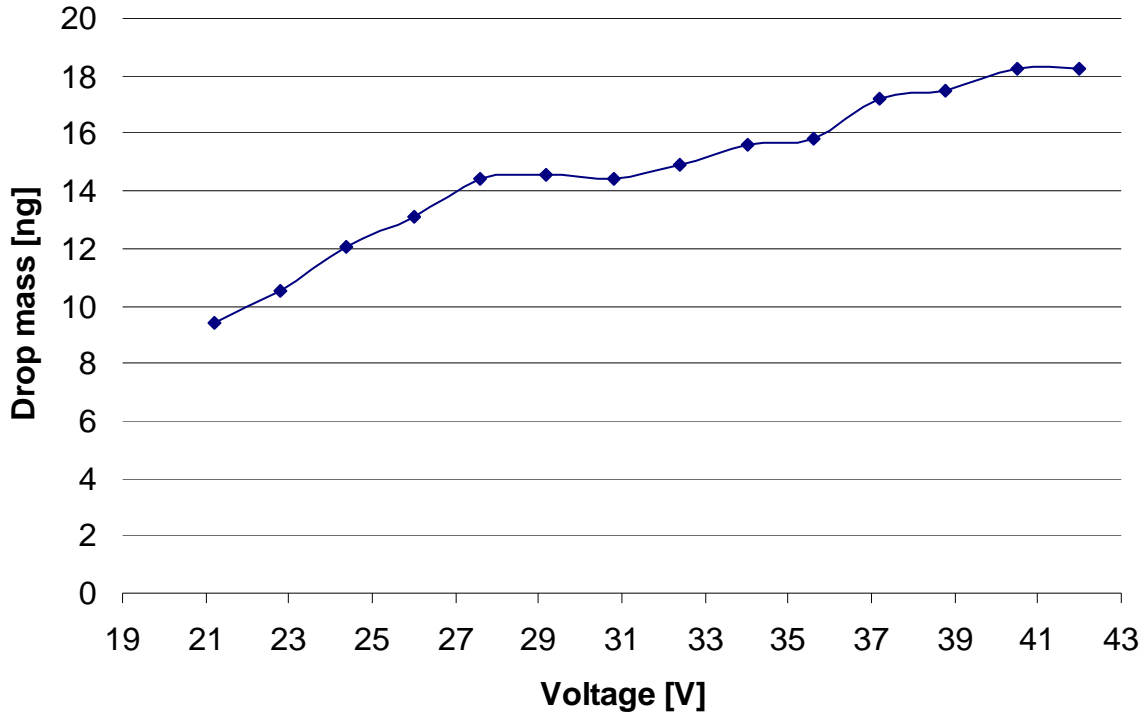

Figure 8 - 6 Drop Mass vs. Voltage





Waveform Basics

The DMP Drop Manager software has a standard waveform that has been found to work very well with the Dimatix Model Fluid. This can be used as a starting point to understand the jetting process.

The typical basic waveform is divided into four segments. Each segment has three properties: duration, level and slew rate. The 0 segment is connected to the last segment of the waveform and is not another segment. Naming it differently has been only done to make the systematic of the waveform more transparent.



Figure 9 - 1 Basic Waveform

The level values, which resemble a percentage of the voltage in segment one and two have the most impact on the jetting process. Changing duration of segment one and slew rate and/or duration of segment two has a strong influence on drop formation. The applied voltage relates directly to the volume of the pumping chamber. Faster changes in voltage change the volume faster, bigger changes in voltage cause bigger volume changes.

The slew rate determines how fast the volume changes.



1.0 Waveform Editor Window Explanation

Controls for making adjustments... Select the segment then use the controls. Watch the drops change velocity and shape on the screen. All adjustments are real time.

Overall pulse length. It is related to the speed of sound in your fluid. As a rule lower viscosity = shorter pulse... higher viscosity longer pulse. Use the duration scaler to go up and down (1.1 – 0.9)

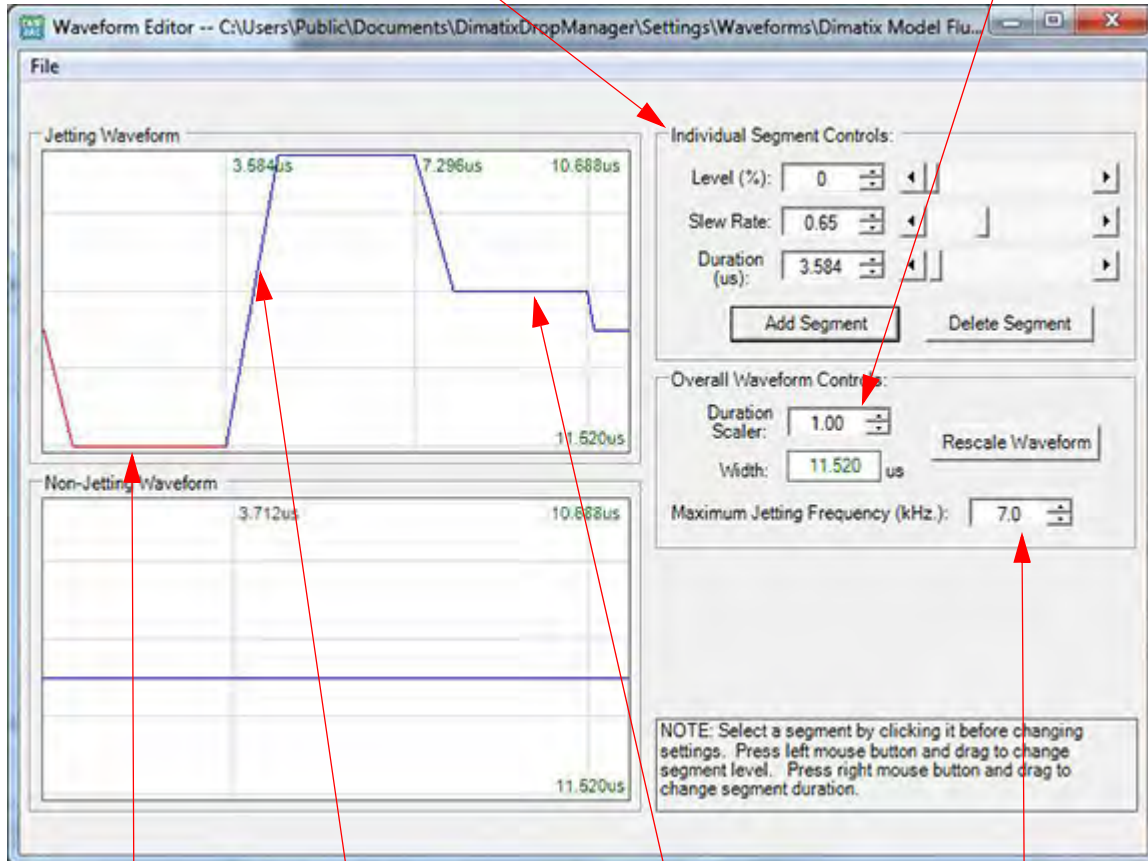

The negative section that draws fluid into the pumping chamber. Followed by a hold / settling time

The firing pulse. The steepness of the slope provides the energy for the initial ejection. It is followed by a hold period.

The dampening segment and is designed to prevent the printed head from sucking air back in. This changes with different materials. This section brings the PZT back to a null position

Limit the maximum jetting frequency for a particular fluid here.

Figure 9 - 2 Waveform Editor

As a starting point, adjust the voltage to get some sort of drop starting to eject. Then adjust the pulse length to get maximum drop velocity. Once the peak velocity is obtained, your fluid is matched to the acoustics of the pumping chamber. Now you can start adjusting the segments to optimize the drop formation.



The following figure shows the start or standby position of the pumping chamber of the piezo-electric printhead as it is before the jetting pulse begins. Notice that the fluid chamber is depressed by a bias voltage.

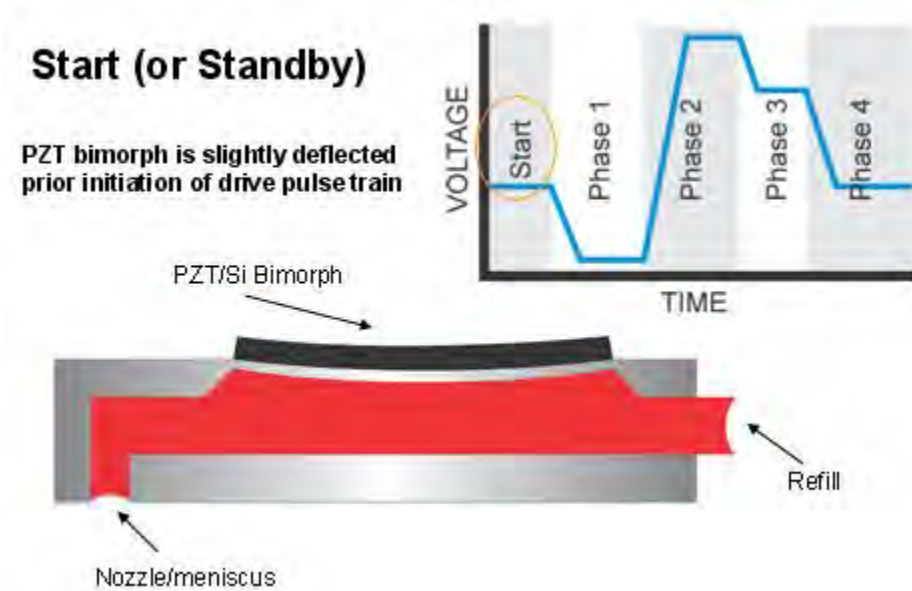

Figure 9 - 3 Waveform – Start

At the beginning of the jetting pulse the decrease in voltage to zero volts brings the piezo back to a neutral straight or relaxed position with the chamber at its maximum volume. In this phase the fluid is pulled into the chamber through the inlet. It also pulls on the meniscus at the nozzle as shown in the following diagram.

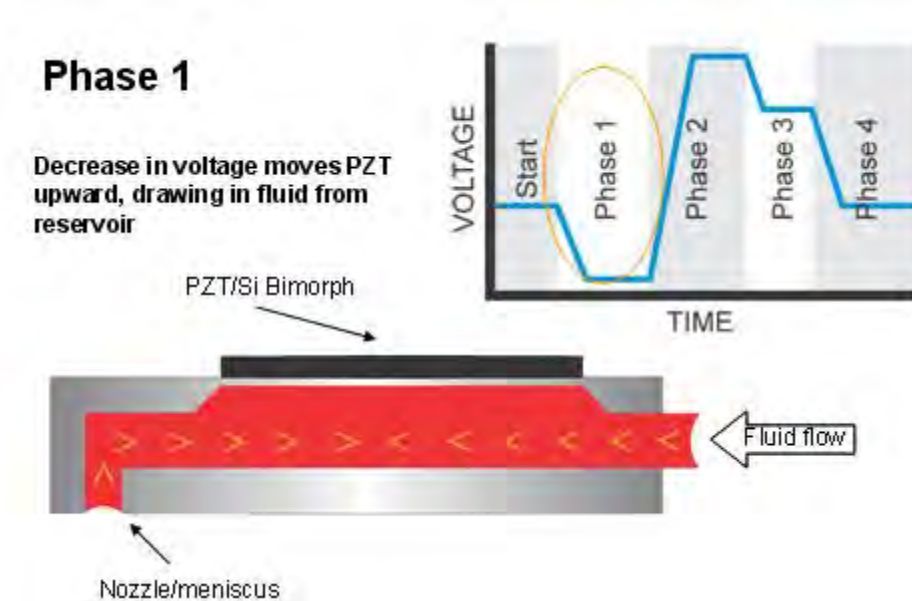

Figure 9 - 4 Waveform – Phase 1



The next phase of the pulse is the drop ejection phase. The chamber is compressed and pressure generated to eject a drop.

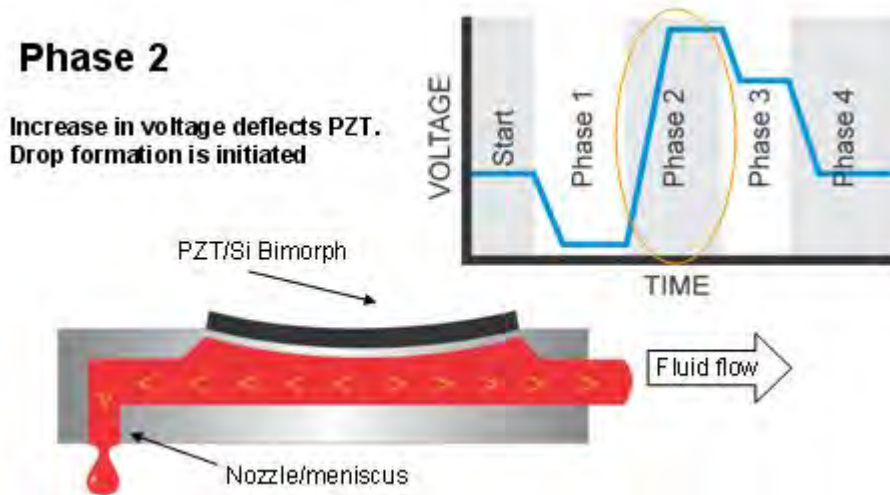

Figure 9 - 5 Waveform – Phase 2

Next is the recovery phase where the piezo voltage is brought back down to its bias level. The chamber decompresses at first only partially and then in full refilling for the next pulse. There is also a pull back on the ejected drop at the nozzle at this point.

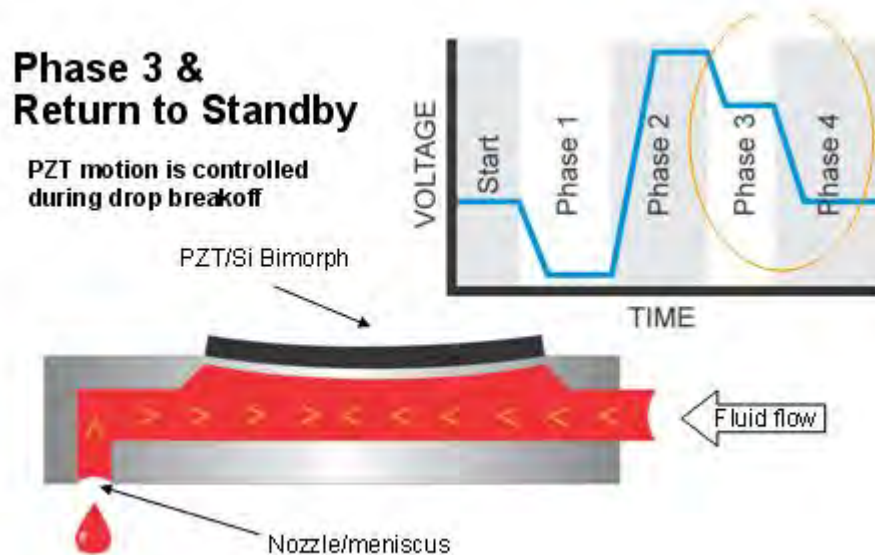

Figure 9 - 6 Waveform – Phases 4 and 5

In the example below the goal was to get a higher jetting velocity without sacrificing too much drop formation quality. In these tests only one parameter was changed at a



time. The observed results are listed below. To perform these tests a model ink was used at these jetting parameters.

	Changed Value	Velocity	Side Effects
Segment 1:	↓ slew rate ↓ duration	↑ ↑	possible tails possible tails
Segment 2:	↓ slew rate	↑	possible tails
Segment 3:	↑ slew rate	↑	-
Segment 4:	↑ slew rate	↑	-





Cartridge

IMPORTANT

When opening the sealed bag that the Fluid Module and Jetting Module come in take care to prevent particles from getting in the Fill Port.

The following diagram shows the major parts of the Cartridge.

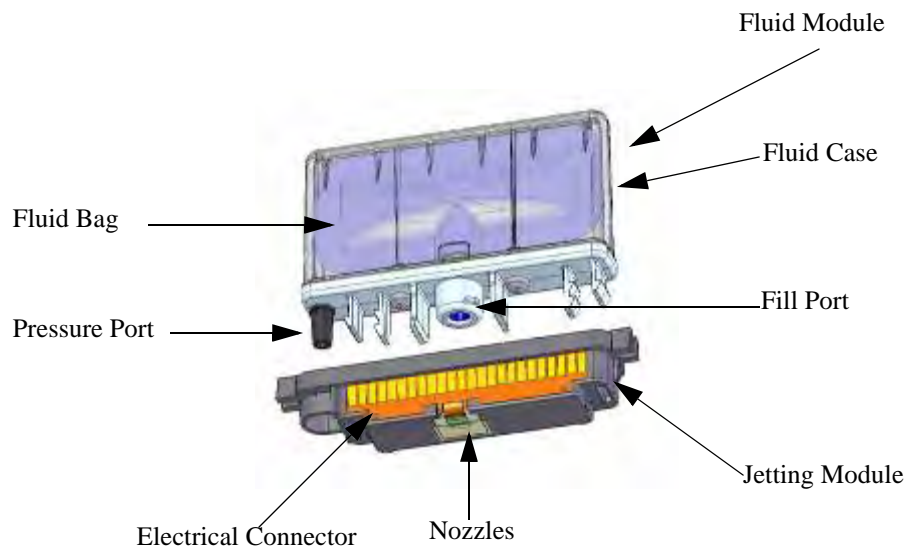

Figure 10 - 1 Cartridge Components

**CAUTION**

Do not remove the white film around the nozzles. It can damage the cartridge.

Do not fill the Pressure Port with fluid. It damages the printer.

Do not get fluid on the Electrical Connector. It may cause electrical shorting.

Always wear the appropriate safety equipment, such as a lab coat, gloves, and safety goggles, when filling a cartridge. Use a ventilated hood if the fluids you are using necessitate such.

1.0 Fluid Module Filling

The following steps show how to fill the fluid module.

1.1 Fill Syringe

1. Pull fluid into syringe (1.5 ml).



Figure 10 - 2 Fluid aspiration

2. Install filter onto syringe. If the fluid is known to be filtered properly and not have agglomerates, you may not need to use a filter. Dimatix Model Fluid does not need a filter.

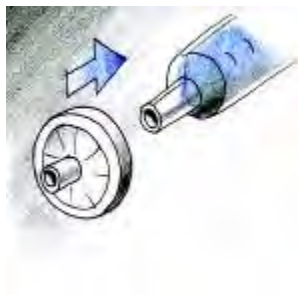

Figure 10 - 3 Filter installation



3. Slip a fill needle on the filter of syringe.

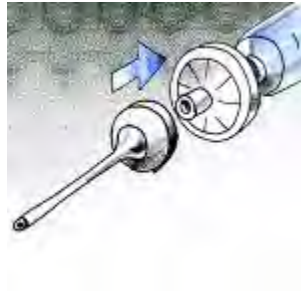

Figure 10 - 4 Tip installation

4. Unscrew and remove the fluid module fill port cap
5. Carefully insert the needle into center fill port trying not to scrape the sides
6. Slowly push the syringe plunger to fill the fluid module.



Figure 10 - 5 Fluid injection

7. Remove syringe.

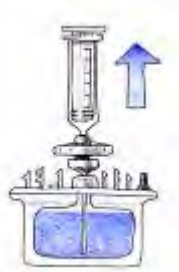

Figure 10 - 6 Syringe extraction

Note: Syringes are typically manufactured with a lubricant (often silicon oil) on the plunger. If your fluid is aggressive or cannot be associated with a small amount of this fluid, then syringes such as glass may be required.



2.0 Assembly

The following steps show how to attach the cartridge.

2.1 Attach Fluid Module to Jetting Module

1. Align the pressure port of the fluid module with the opening in the jetting module.
2. Push the two halves straight together until the **SECOND** snap is felt and heard. This is a fairly rigid connection and takes a fair amount of force.



Figure 10 - 7 Cartridge assembly

3. Once the two pieces are snapped together the fluid can flow into the jetting device of the cartridge. **Let the cartridge set for 30 minutes with the nozzles facing down.** At this point care must be taken to protect the nozzles of the cartridge. If the fluid is very low surface tension it may flow out of the nozzles. If it is highly volatile it may start drying at the nozzle leaving residue and thereby preventing it from jetting. It is best to immediately place the filled cartridge in the DMP.

Note: While snapping the two modules together not push on or touch the nozzle plate.



Do not dispose of this product as unsorted municipal waste. Collection of such waste separately for special treatment is necessary.

(Entsorgen sie dieses Produkt nicht als unsortierten Hausmüll. Eine Fachgerechte Entsorgung ist nötig.)



3.0 Cartridge Maintenance

The DMP contains hardware and software to perform one or more maintenance activities which are designed to initialize and maintain optimal jetting performance.

- The cleaning station contains an absorbent pad to draw fluid off of the nozzle plate when it is brought close to it. It does not actually touch the nozzle surface but rather it contacts the face plate of the cartridge around the nozzle plate. The pad is replaceable.
- The cleaning station uses air pressure to pressurize the outside of the fluid bag, which forces fluid out through the nozzles. This is mainly used to initially prime the cartridge, but also as a method for reviving problem nozzles. The DMP includes a pump for this function, which is also used for meniscus control.

Specific functions include:

- **Purging** process pressurizes the cartridge to push fluid out the nozzles to remove trapped air to prime or clear the nozzles.
- **Spitting** is jetting drops out of the nozzles at a selected frequency and duration. Tickle mode sends a non-jetting pulse to the nozzles keeping the ink in motion at the nozzle plate to help keep it ready to jet.
- **Blotting** is when the cartridge lowers to the Cleaning Pad so that the pad can adsorb excess fluid from the nozzle plate.
- **Meniscus Control** is a low level vacuum applied to the ink reservoir to prevent ink from flowing out of the cartridge nozzles.



3.1 Cleaning Function Definitions

Maintenance Function	Definition	Benefits	Comments
Purging	Applies air pressure to outside of fluid bag to force fluid through entire fluid path and out all nozzles at once.	Required for initial use to force air out of fluid path (prime). Clears severely clogged nozzles. Can also be used to lower printhead temperature by purging hot fluid and bringing system temperature fluid into the path.	Produced high flow rate of fluid, so purge time should be minimized for 1 ml cartridges. Used as last resort for clearing clogged nozzles.
Spitting	Ejecting a predetermined number of drops at a predetermined frequency from one or more nozzles.	Clears the nozzles, brings fresh fluid to the pumping chamber and nozzles, keeps fluid path surfaces wet.	Consumes ink that cannot be used for printing. Typically used on a periodic basis, e.g. every X printing passes or every Y seconds, to maintain robust jetting performance.
Blotting	Bringing an absorbent and/or wicking medium in close proximity to nozzle plate (may lightly touch) to remove excess fluid from the nozzle plate. No wiping action.	Fluid puddling around nozzles can partially attach to ejected drops causing misdirected jetting. In extreme cases, puddled fluid will fill nozzle and prevent jetting altogether. In addition, excess fluid on the nozzle can fall or be flung off onto substrate or printer components.	Risk of cross contamination when switching cartridges of different fluid if cleaning pad is not changed.
Tickle Mode	Exercising the pumping chamber at low amplitude to rhythmically pulsate the nozzle exit meniscus.	Retards skinning over of nozzle exit meniscus. Keeps nozzle exit wet.	May be sufficient to keep nozzles alive for lower volatility fluids as an alternative to spitting. Used while head is capped, or for lo use nozzles during printing.



4.0 Failure Modes, Prevention and Recovery

	Failure Mode	Symptoms	Prevention	Recovery
1	Volatile solvents evaporate (dry) when printhead is not being used. Fluid viscosity increases, fluid dries inside of nozzles, and crusts on nozzle plate surface.	When printing starts again, nozzles do not fire, or fire poorly (low velocity, misdirected).	Cap printhead when not printing. Spit into cap to saturate air with solvent vapors. Spit occasionally and/or use tickle mode to keep nozzles alive.	Spit or purge, following with wipe or blot. Replace cartridge if severe.
2	Volatile solvents evaporate (fluid dries) in nozzles that are not being used. Fluid viscosity increases, fluid dries inside of nozzles, and crusts on nozzle plate surface.	When printing starts again, nozzles do not fire, or fire poorly (low velocity, misdirected).	Exercise unused nozzles using tickle mode, and/or by spitting occasionally.	Spit or purge, following with wipe or blot. Replace cartridge if severe.
3	In newly filled cartridges there is air in the fluid path.	All nozzles fail to fire.	None.	Purge the head to force air out of fluid path and fill pumping chamber and nozzles with fluid. Follow with blot to remove excess fluid from nozzle plate.
4	Air becomes ingested in the nozzle due to excessive drop ejection dynamics.	Some or all nozzles do not fire.	Adjust drive waveforms and/or fluid properties.	Purge the head to force air out of fluid path and fill pumping chamber and nozzles with fluid. Follow with blot to remove excess fluid from nozzle plate.
5	Fluid oozes out of the nozzles due to gravity and capillary action.	Fluid collects on the face plate (see next item below).	Increase meniscus control vacuum level.	Blot the nozzle plate.
6	Drops and/or puddles of fluid collect on the nozzle plate and hang down.	Excess fluid temporarily attaches to drops as they are being ejected causing misdirection and/or low velocity. Nozzles are flooded and do not eject drops at all. Fluid falls onto substrate or printer, or is flung off by carriage motion.	Adjust drive waveforms to create more crisp drop ejection. Blot or wipe surface periodically during printing. Increase meniscus control vacuum level.	Blot the nozzle plate.
7	Pumping force is not enough to overcome meniscus control vacuum.	Some or all nozzles do not fire.	Decrease meniscus control vacuum level.	Decrease meniscus control vacuum level.





Print Quality Troubleshooting

Printhead jetting issues and subsequent print quality issues typically fall into four main categories. This section shows the most likely causes, the resulting print artifact and corrective action that can be taken to mitigate the effects.

1.0 Misdirected Nozzles

Misdirected nozzles refers to drops that are traveling off axis from left to right, or more difficult to resolve is front to back. The following figure illustrates a jet ejection off axis in the drop watcher.

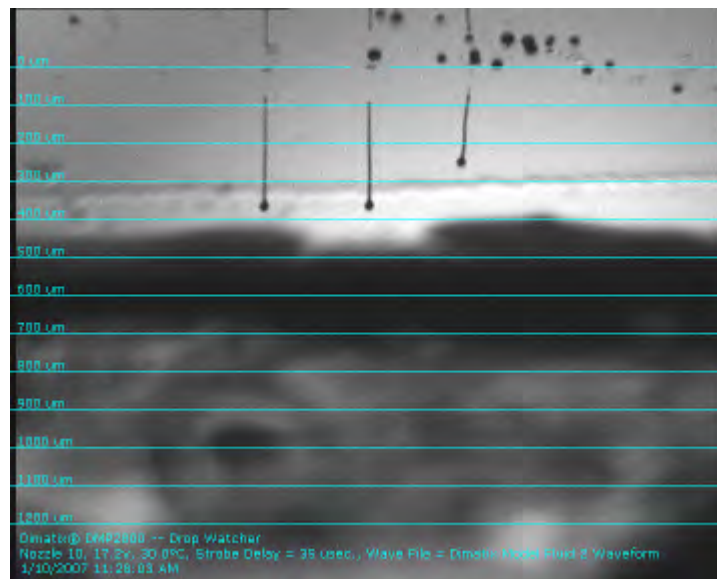

Figure 11 - 1 Jets jetting off axis

The primary causes of misdirected nozzles are contamination at or on the nozzle plate and or air inside the nozzle descender. Contamination is typically a static condition, meaning that the drop consistently jets to the side in spite of repeated cleaning cycles. This indicates that debris is lodged just inside the nozzle and is forcing the drop to eject at an angle.



When an air bubble is present the ejecting drop or more specifically the ligament extension appears to swirl as the drop is being ejected. This is caused by micro-bubbles in the ink that are stubbornly residing just inside the nozzle opening and affect the drop formation and typically drop velocity. Figure 11-2 shows the result of misdirected nozzles on a printout. The print spacing in Figure 11-2 has been increased so as to better display individual drops and placement issues. In Figure 11-3 there are multiple nozzles ejecting off axis as well as mismatched velocities and poor sustainability.

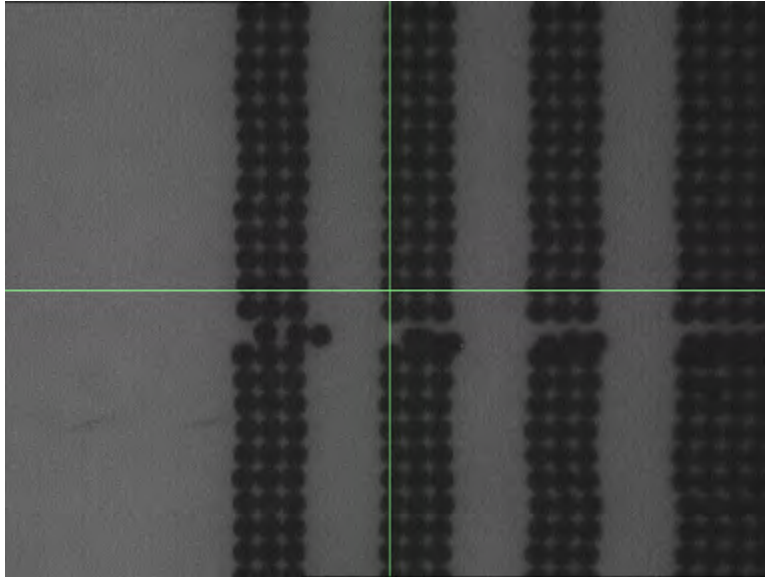

Figure 11 - 2 Misdirected nozzles

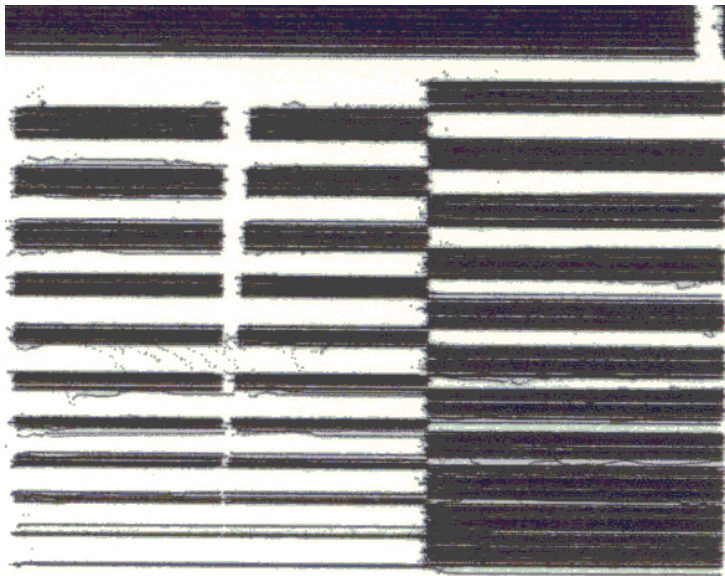

Figure 11 - 3 Multiple nozzles jetting off axis



1.1 Corrective actions:

- Filtering the fluid before jetting helps to remove any agglomerated particles or debris that may block the nozzles. Micro filters in the range of 0.2 - 0.45 micrometers have been found to be adequate. Ensure as well that the fill tip is clean.
- Check to see that the cleaning pad has not become saturated or dried over, replace if there is any doubt. A cleaning pad that has lost its absorbent properties affects jetting performance.
- Perform a purge cycle with a known good cleaning pad in place and retest. In the event that the nozzle has accumulated dried fluid, moisten a clean room cloth with the appropriate solvent and place atop the maintenance pad then run a cleaning cycle. This should dissolve the residue.
- In the event that the above actions prove unsuccessful, use the advance features of the cartridge settings to map around the offending nozzle. Be sure to save the new cartridge settings and then reload them at the top menu to make the changes active.
- Certain fluids respond well to degassing prior to loading the fluid module. Degassed fluids can aid sustainability and allow for the printhead to start up faster.

2.0 Non-Jetting Nozzles

Non-jetting nozzles are nozzles that do not eject a drop under any condition and are adjacent to nozzles that are jetting properly. This indicates that the waveform is correct. In the following figure you can see that the adjacent nozzles are jetting properly yet nozzle #15 is showing no drop ejection.

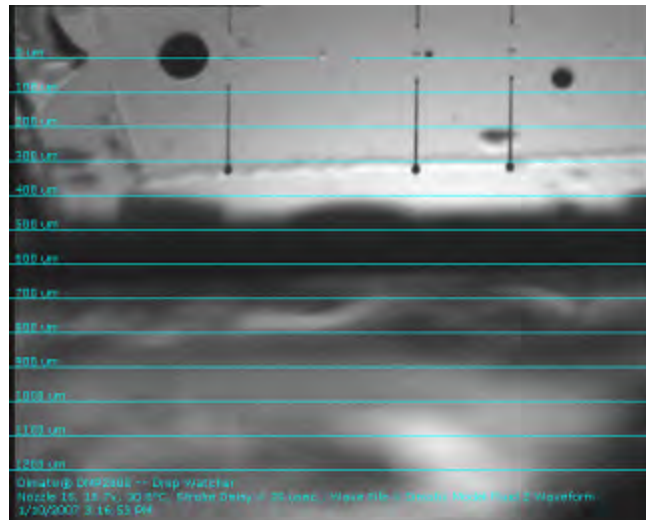

Figure 11 - 4 Non-jetting nozzles



When a situation arises that a nozzle that does not seem to want to jet, there are usually only two causes. The first would be air entrapment in the pumping chamber which effectively cancels or dampens the jetting pulse. If this is the case usually the meniscus continues to flutter slightly yet there is insufficient energy to force a drop to form. The second occurrence is when the nozzle has become plugged due to debris in the fluid path or the nozzle itself has dried over. When a nozzle has become plugged or dried out you are not able to observe the subtle pulsations of the meniscus in the nozzle opening. In the following figure you can see the effect of a non-jetting nozzle #7 on a print out.

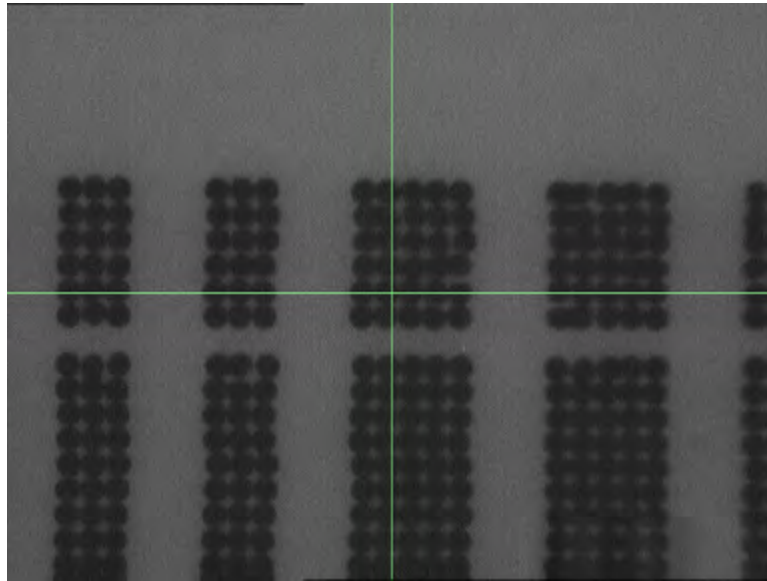

Figure 11 - 5 Non-jetting nozzle #7

2.1 Corrective actions:

- As previously mentioned a fresh cleaning pad is critical to the head performance. If there is pulsation of the meniscus visible at the nozzle then the problem may be air trapped in the fluid path. It is not uncommon to allow a printhead to sit for an hour or two after loading. The result is after sitting the micro-bubbles that may initially resist purging or wetting are redissolved into solution. A purge cycle of 0.5 – 1.0 seconds may also help to remove the trapped air.
- If there are no visible pulsations of the meniscus then the nozzle is likely plugged or fluid has not reached the nozzles. Applying an appropriate solvent to the nozzle plate may dissolve dried jetting fluid. If the nozzle has become occluded with foreign debris then you need to use the advanced features of the **Cartridge Settings** window to map around that specific nozzle. Remember to degas and filter your fluids before loading the fluid module.



3.0 Non-Matched Velocities

When a new printhead is installed it is absolutely essential that you take the time to adjust the drop velocities for all sixteen nozzles. This has a direct impact on image quality and overall line fidelity. Within the cartridge settings are voltage adjustments for each individual nozzle. Perform a **Calibrate Nozzle View** from the **Tools** menu in the **Drop Watcher** window. In the following figure you see that nozzle #1 is indeed running slow. When the drop velocities are mismatched the result is vertical lines that have uneven edges.

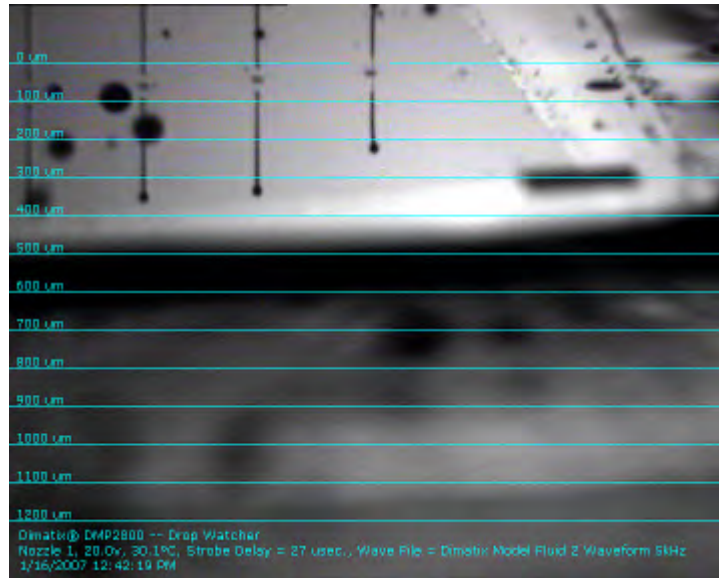

Figure 11 - 6 Nozzle #1 running slow



As seen in Figure 11-7 nozzle #16 is jetting slower than the rest, note the impact on the vertical line.

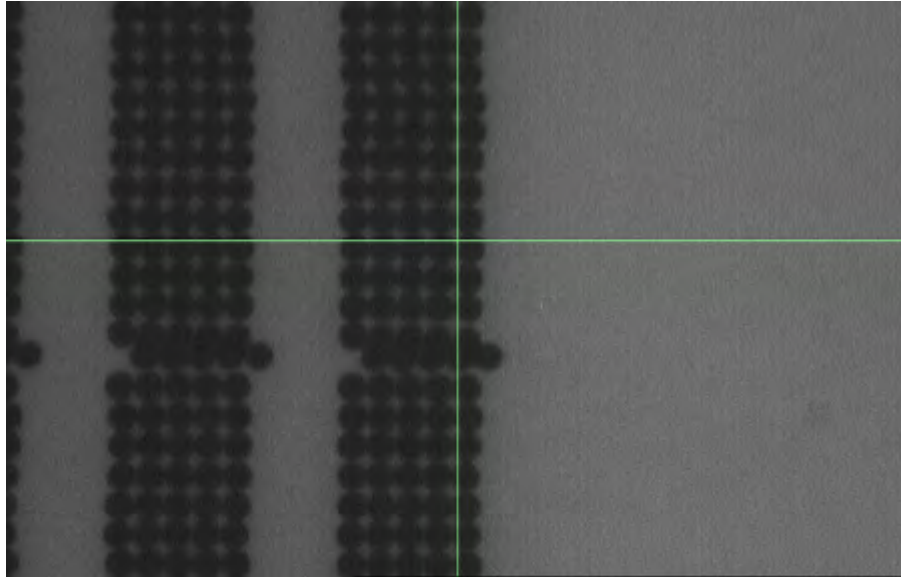

Figure 11 - 7 Nozzle #16 jetting slowest

3.1 Corrective action:

- Within the Drop Watcher use the 100 μ s delay adjust each nozzle individually by right clicking on the selection box for each nozzle. Having done an **Align Nozzle View** the nozzle being adjusted align to the zero line and make velocity matching very easy. Be sure to save the cartridge settings. Then reload them in order for the system to actually use them.
- Pay attention to the drop formation and in particular at what distance the drop coalesces into a fully formed drop. Higher drop velocities may slightly improve drop placement but the sacrifice would be a less than round drop. Lower velocities may yield a round coalesced drop but due to lower velocity may tend to wander in placement accuracy.
- Use the drop watcher as an indicator for setting the printhead fly height based on the distance that yields a fully formed drop.

4.0 Cartridge Alignment & Drop Offset

Perhaps the most often missed contributor to print quality is the proper alignment of the print cartridge. The DMP software relies on the operator to physically rotate the head to a saber angle that matches the grid spacing in the pattern to be printed. Failure to adjust this angle accurately results in gaps or excessive overlap as well as vertical lines that have a noticeable saw tooth to them. The following figure is an example of a cartridge alignment that is off by an angle of -2 degrees with nozzle #16 off speed.



In order to ensure that the pattern you intend to print is aligned to your substrate a drop offset routine needs to be run after the cartridge alignment is completed.

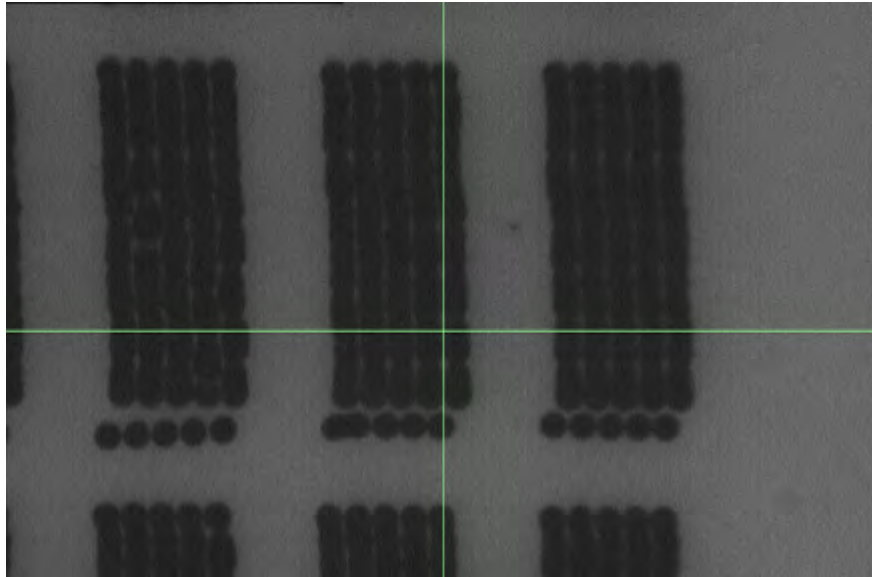

Figure 11 - 8 Alignment off by -2 degrees

In Figure 11-9 you can see the result when the cartridge is off by an angle of +2 degrees.

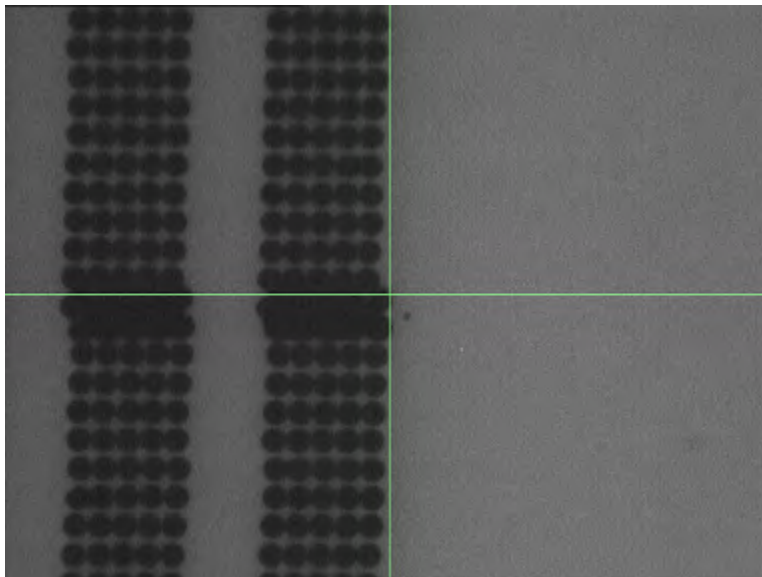

Figure 11 - 9 Alignment off by +2 degrees



Figure 11-10 shows a cartridge that has been properly aligned. Note the placement of the vertical rows and the absence of overlap or gap at the printing pass boundaries.

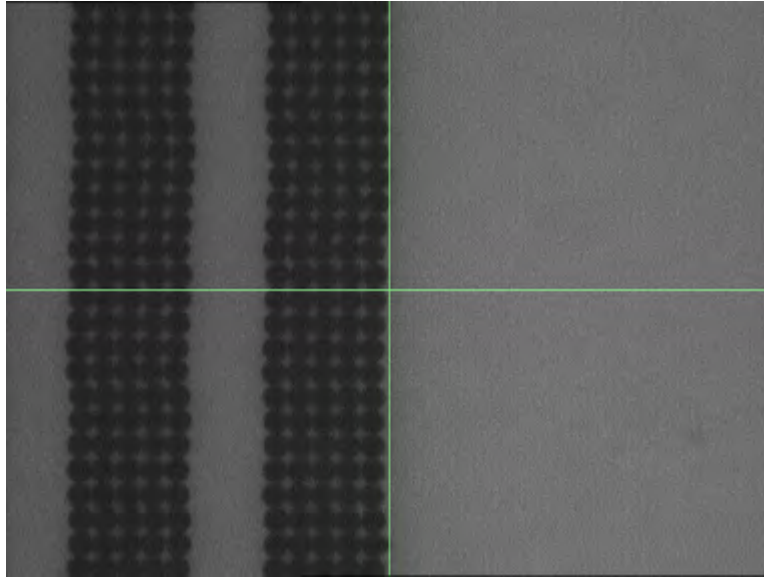

Figure 11 - 10 Properly aligned cartridge

4.1 Corrective action:

- In the **Fiducial Camera** window in the **Tools** menu click on **Check Cartridge Angle** and follow the on screen prompts. Once the pattern has printed and you have performed the required measurement, the software prompts you to make an adjustment clockwise or counter clockwise. Repeat this adjustment until the reported error is less than .25 degrees.
- To ensure drop placement accuracy it is necessary to run the **Set Drop Offset** from the same pull down menu, follow the on screen prompts. This provides the software with an accurate XY 0,0 position to reference from.



5.0 Things to remember

- A piezo driven printhead relies on incompressible liquids throughout the fluid path and does not tolerate air in the system well at all.
- Sometimes allowing the head to sit undisturbed for an hour is the best way to ensure good wetting of the printhead.
- Whenever a print cartridge is replaced the saber angle needs to be checked and a drop offset adjustment has to be performed again, in this particular order. The nozzle velocities have to be re-adjusted.
- Using the drop watcher, determine the maximum jetting frequency that your fluid runs well at, assign that value in the waveform editor and then save that waveform to the **Cartridge Settings** file. Failure to do so could result in jetting frequencies that are beyond the limits of your fluid to sustain and result in misdirections, poor sustainability, and unacceptable print quality.

6.0 System Faults

There are several error messages that may occur during operation of the DMP. In these cases you usually get a message to power off the DMP and then power it back on. If the problem is not remedied by turning the DMP off (leave off for 5 seconds minimum) and then back on, the system has to be returned to FUJIFILM Dimatix for service.

6.1 Faults

- **The cartridge drive amplifier has malfunctioned.**

This is an error in the Amplifier calibration as it tries to communicate with the jetting module. Try replacing the jet cartridge. Additionally ensure that the contacts on the head carrier are clean and free of contamination and that the cartridge is seated and latched in position properly.

- **The platen heater is malfunctioning.**

This is a result of the platen heater having a short, an open or a thermocouple is not reading.

- **A motor has malfunctioned**

One of several motors has detected an error. This is related to a signal from the FPGA and usually indicates an over current condition. With the printer powered down, check for material blocking the platen or carriage movement then restart. If you get this message with the **Platen Theta Home Sensor** you can try to recover from that error yourself. Therefore turn off the printer and shut down the software. Now with you hand reach under the left front of the platen. You should feel a small stepper motor and



a shaft sticking out of it. Push the shaft all the way into the motor until its end is flush with the motor. Now turn the printer back on and initialize the system. If the error persists you most likely have a broken theta sensor or a damaged sensor flag. In both cases you need to contact Dimatix customer support @ (408) 565-7474.

- **Driver error**

The system has reported an error related to the USB driver. Power the Computer and Printer off. Rearrange the USB connectors and restart the computer then the printer.

- **Encoder index**

The printer has failed to recognize the index sensors associated with the X and or Y axis. Ensure that there is nothing on the encoder strips such as paper chafe or ink deposits and make sure the stages are free to move. Power the system down and retest.

- **Home sensor**

Home sensors are associated with the X axis, Y axis and Platen rotation. Ensure that there is nothing blocking any of the axis movement and cycle the printer power. If condition persists call Dimatix Customer Support @ (408) 565-7474.

- **Movement error**

This is a positional fault. This occurs when the printer is commanded to move to a specific position, but is not within the preset tolerance when motion stops.

- **The printer's 3 volt power supply has malfunctioned.**

This is a failure of the logic level power. Turn the DMP off and wait 5 seconds then turn back on. If condition persists call Dimatix Customer Support. (408) 565-7474.

- **The printer's 5 volt power supply has malfunctioned.**

This is a failure of the logic level power. Turn the DMP off and wait 5 seconds then turn back on. If condition persists call Dimatix Customer Support @ (408) 565-7474.

- **The purge pressure is too low.**

The pressure side of the air system has detected a leak or the pump pressure is insufficient. Replace the cartridge with a known good cartridge and retry. Ensure that the cartridge is fully seated in the head latch assembly. Refer to *System Diagnostics* in the following section or the Help menu on the main DMP window.

- **The cartridge meniscus vacuum can't be controlled.**

The vacuum side of the system has detected a leak or the vacuum generator is malfunctioning. Replace the cartridge with a known good module and retry. Ensure



that the module is fully seated in the head latch assembly. Refer to *System Diagnostics* in the following section or the Help menu on the main DMP window.

- **The printer's internal memory has failed.**

The Main board memory is at fault. Shut down the Drop Manager Software and the DMP. Restart after 5 seconds. If the condition persists, call Dimatix Customer Support @ (408) 565-7474.

- **The printer CPU firmware upgrade has failed.**

In this case the system asks you to Try Again. Possibly a timing issue between the Main board, USB and Computer.

- **The printer FPGA upgrade has failed.**

In this case the system asks you to Try Again. Usually a check sum error has occurred. Similar to a CPU firmware upgrade failure.

- **An undefined printer error has occurred.**

This is typically a motion related error that occurs due to the lid being opened while the printer is initializing or performing some type of mechanical motion. Turn the system off and restart after 5 seconds.

7.0 System Diagnostics

If there is a fault with the pneumatic system or the **Theta Axis** the following screens can be found in the **Help** menu in the **Drop Watcher** main window. You can identify and



troubleshoot the system to some extent on your own. Simply place the mouse cursor on the **Test Control** block that you wish to test and follow the instructions.

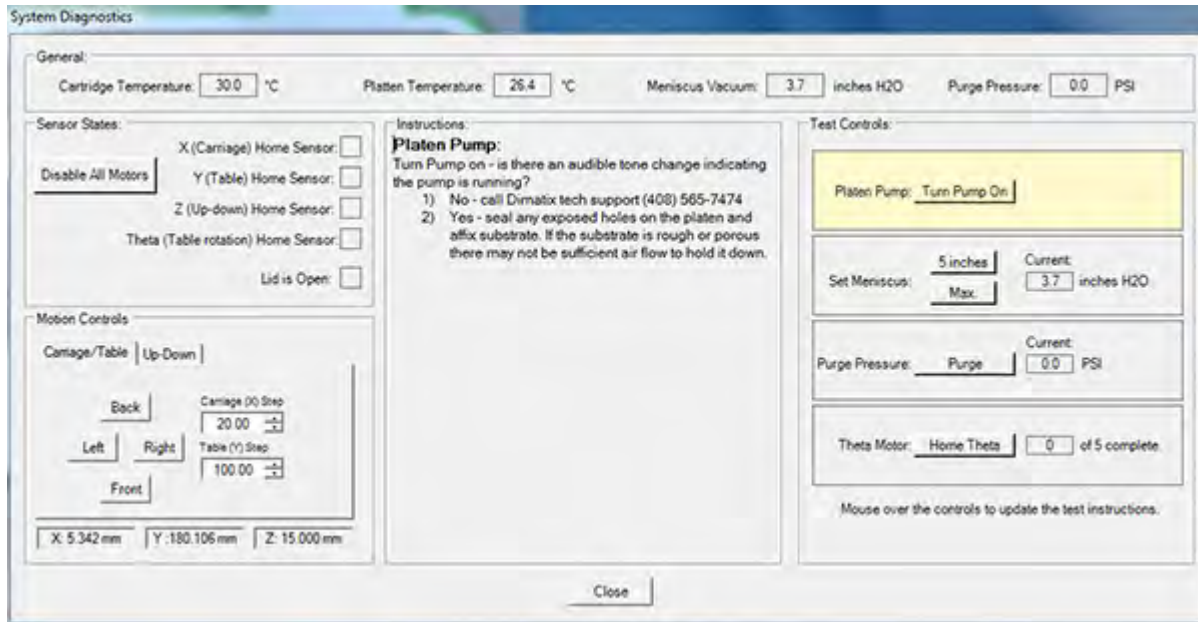

Figure 11 - 11 Platen Pump screen

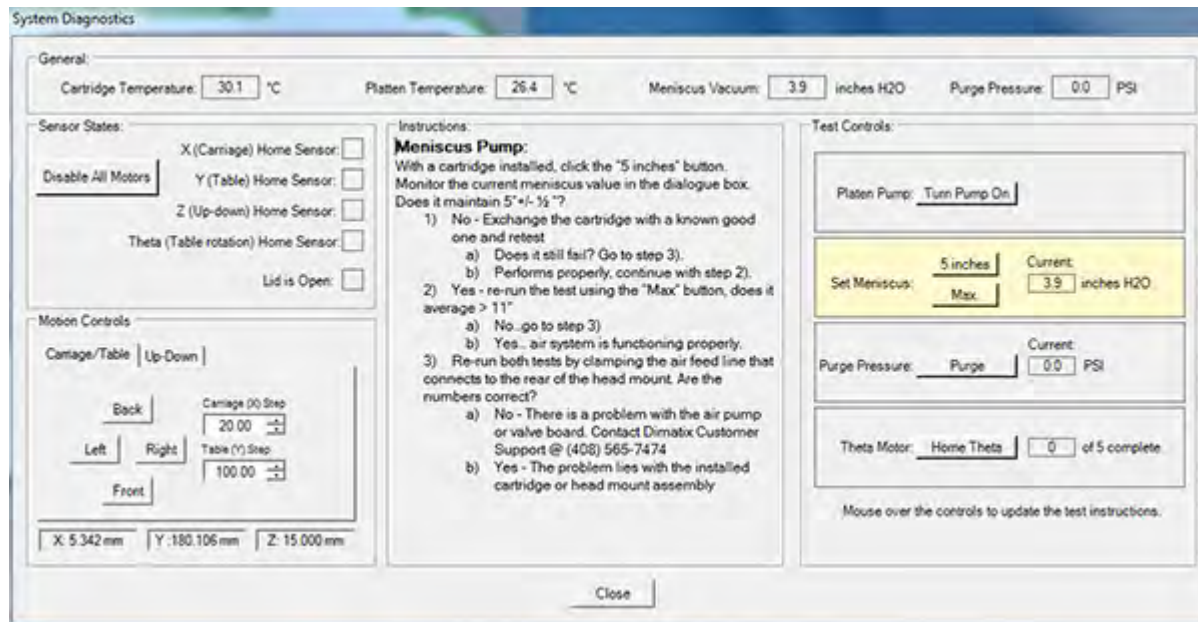

Figure 11 - 12 Set Meniscus screen

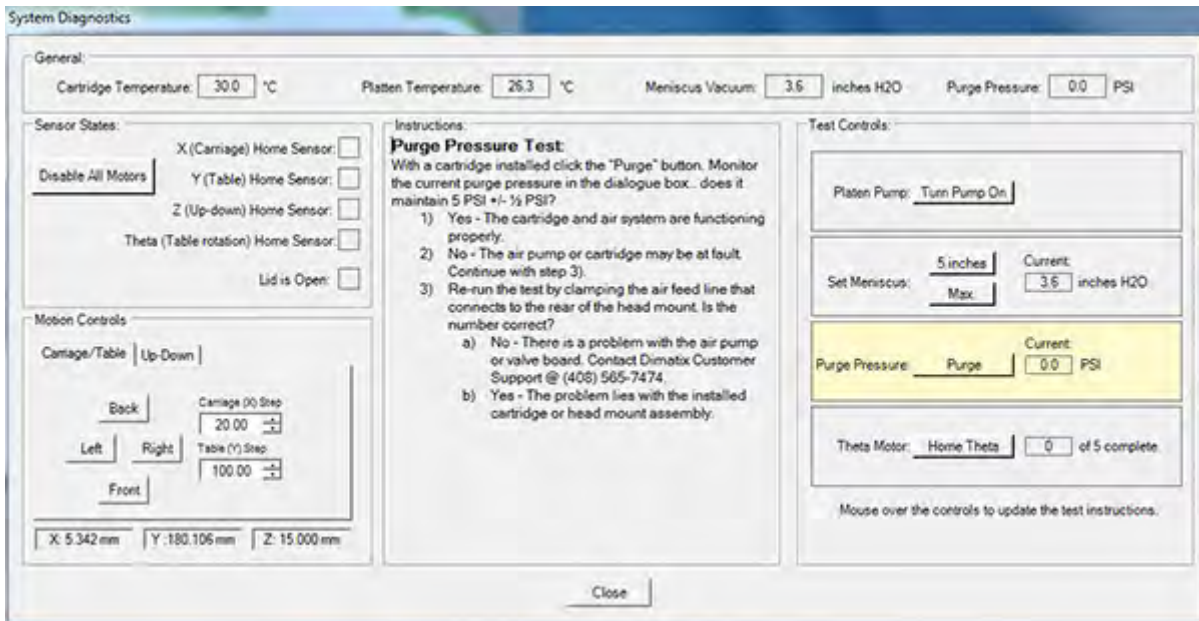

Figure 11 - 13 Purge Pressure screen

If there is an error with the Theta motor or platen the following screen can help identify and resolve the problem.

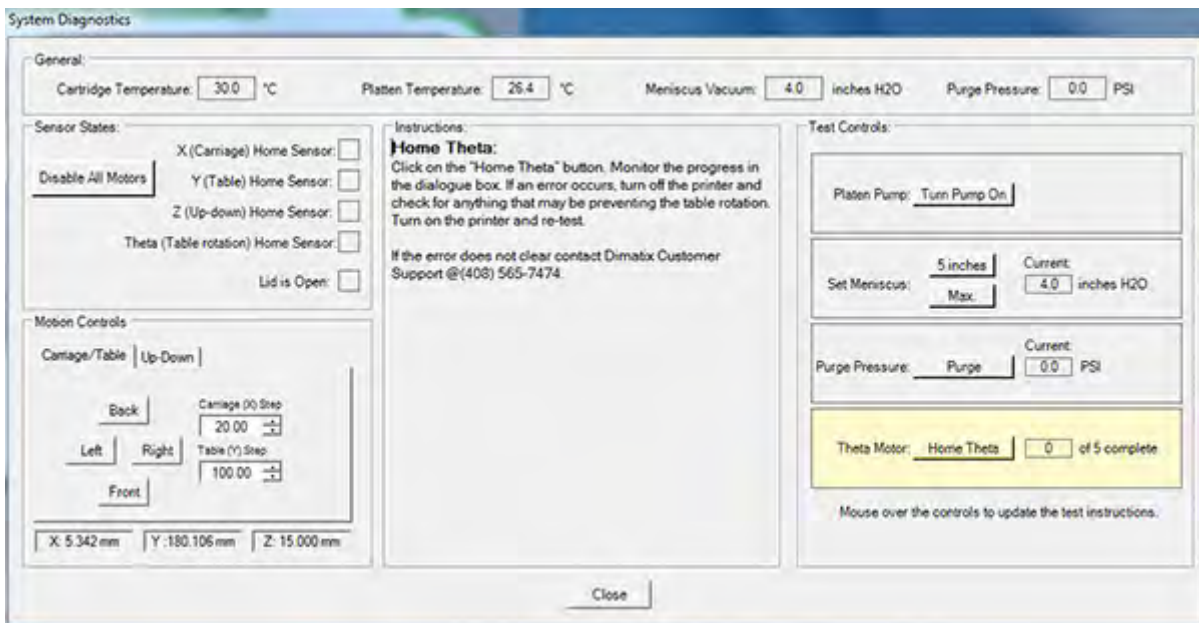

Figure 11 - 14 Theta Motor screen

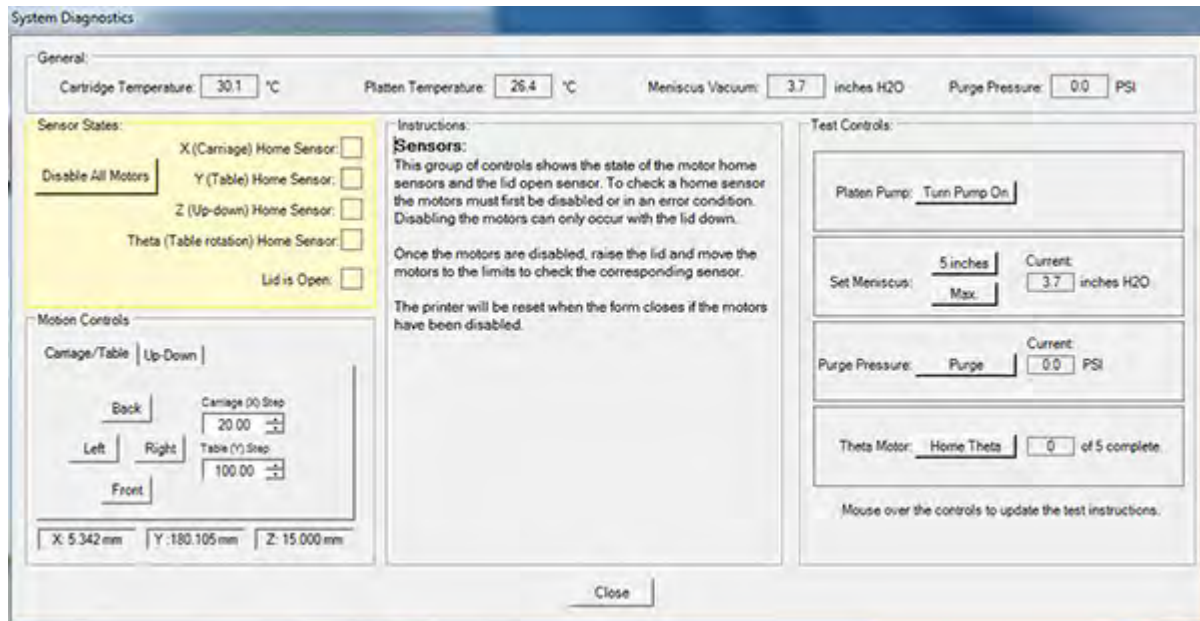

Figure 11 - 15 Sensor Status screen

If there is an error referring to sensor issues, use this screen to troubleshoot sensor status problems.

- **Sensor Status** – this group shows you the current status of your printer. A green colored box means that the sensor has been tripped.
- **Disable All Motors** – This button disables all motors in the DMP2800 printer. You can now open the lid and move the carriage, stage, and Z-Axis by hand. If you move them into a sensor, you can observe sensor behavior.

Note: This is a troubleshooting tool. You should not do this unless you are having problems with your printer.

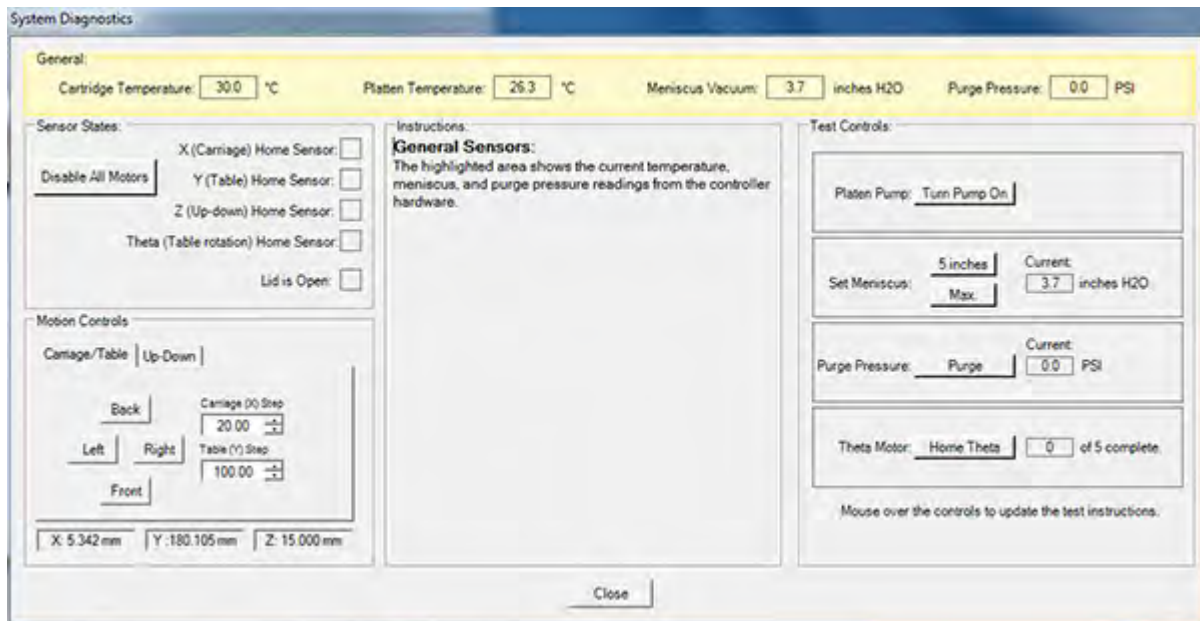

Figure 11 - 16 General Status screen

- **General** – You can read out all of the current values of the controlled parameters of the printer in this section of the **System Diagnostics** screen.
- **Motion Controls** – The motion controls can only be used when the lid is closed. They can be used to make the stage of the printer go to a specific position and stay there in order to troubleshoot the printer and the software. You cannot print in these positions.

8.0 Preventative Maintenance

When installing cartridges, inspect the connector on the carriage holder. If you see any fluid on the connector, wipe it off with a clean lint free cloth or other similar material. Additionally, wipe any other fluid or debris from the holder area.

Inspect the pressure seal area on the cartridge holder also. Make sure it is free of debris to ensure that proper pressure regulation can occur.

Vacuum the fan filters located on the bottom of the printer.

Grease the Y-axis lead screw with Tri-Gel 1200SC as required.

Inspect the encoder strips for obstructions, clean with soft cloth as required.



9.0 Reference Information

Please visit the FUJIFILM Dimatix web site and the Tech Support link at the bottom of the FUJIFILM Dimatix home page (www.dimatix.com) for the latest application and ink jet usage information in the deposition field.

Signing up on the Tech Support extranet is free for DMP customers and provides you access to a lot of inkjet printing related information. If you have not setup your Tech Support extranet access yet, click on the Tech Support link at the bottom of the FUJIFILM Dimatix home page (www.dimatix.com). On the Tech Support Welcome page, select Create Account. Complete the information and select Save.

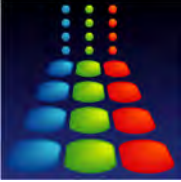

Remote Control

The Remote Control function allows FUJIFILM Dimatix customer support to assist you to troubleshoot your printer and software. This button disables video streaming to the fiducial camera and drop watcher camera video screens. Once the video streaming is disabled it is possible for your computer to broadcast all screens to remote locations without running into bandwidth problems.

Once Remote Control is activated the drop watcher screen, the fiducial camera screen, and the DDM screen all show red Remote Control labels. The camera screens only update



when you click on the Update Image buttons in the upper right corner of the video screens.

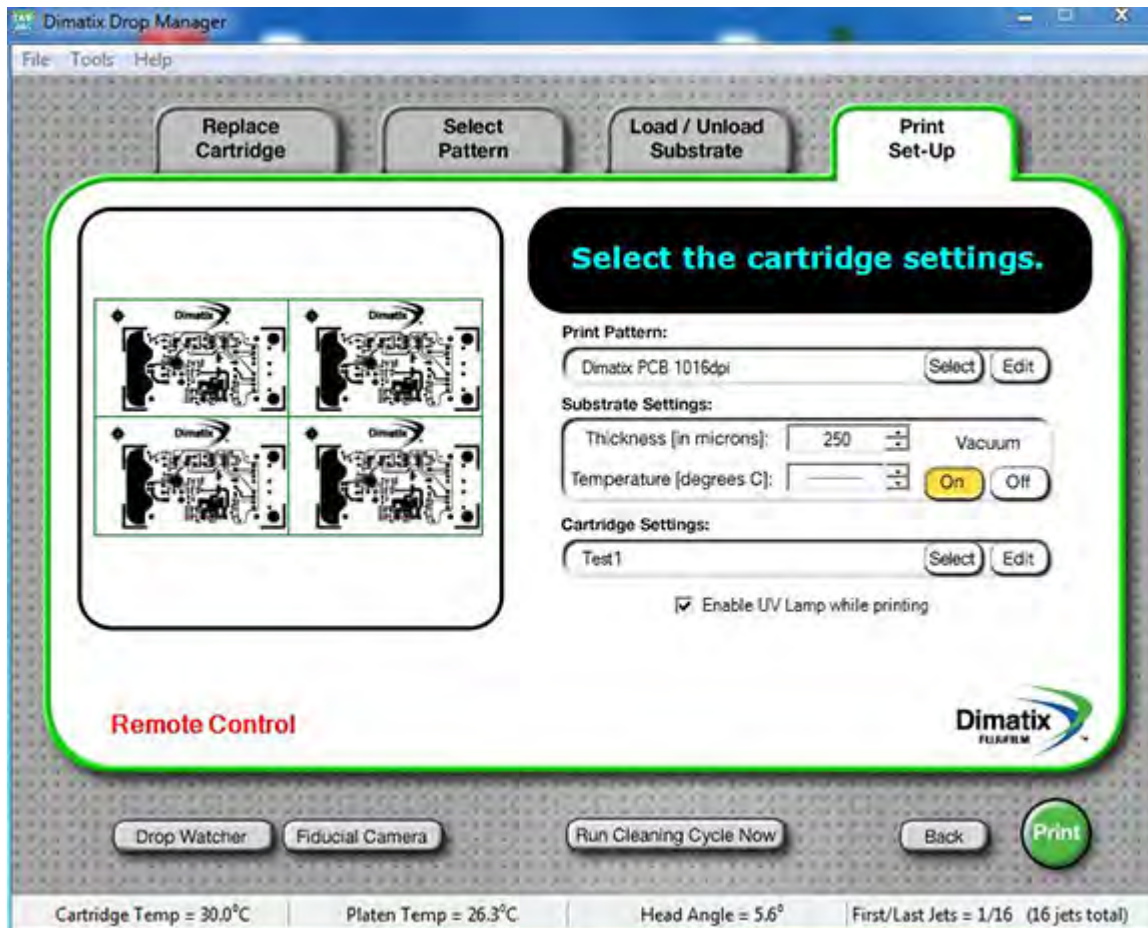

Figure 12 - 1 DDM main screen in Remote Control mode

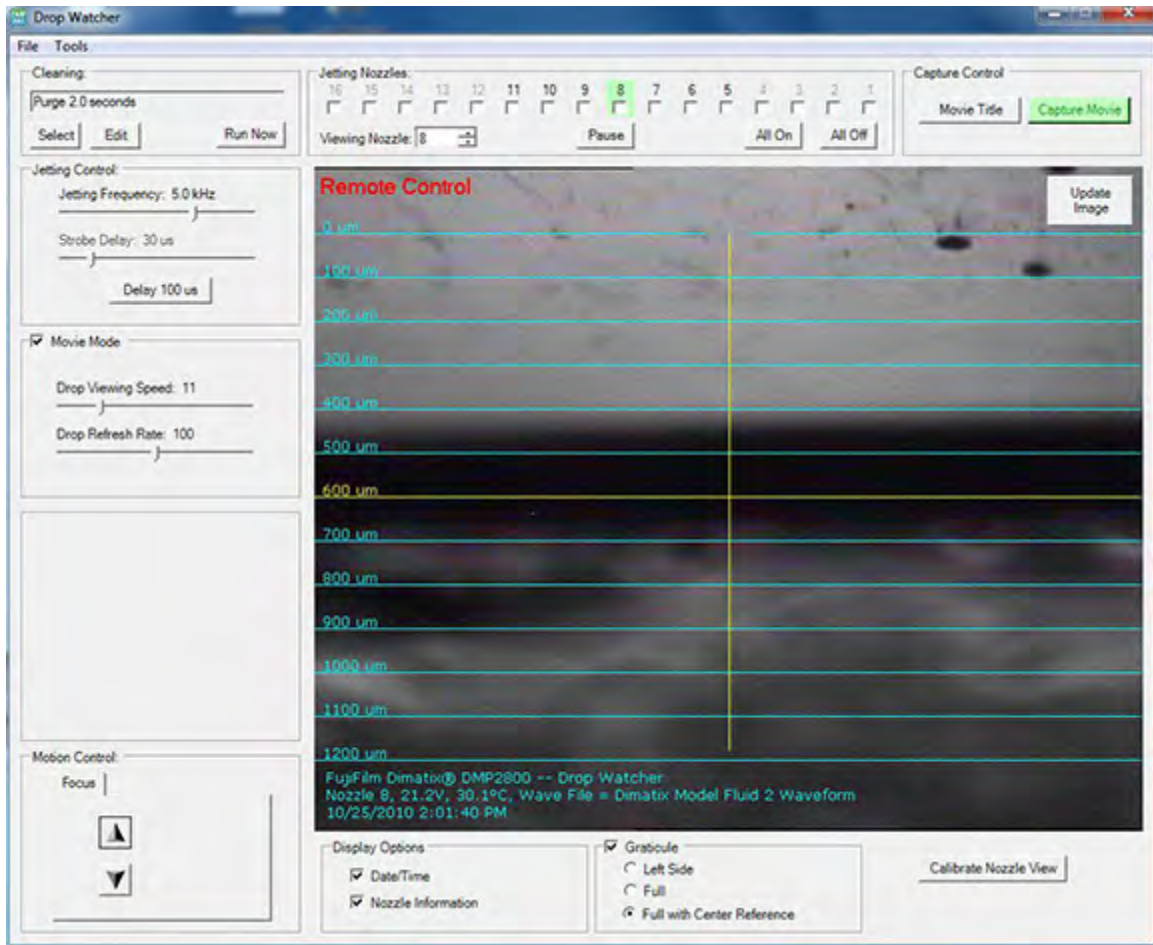

Figure 12 - 2 Drop watcher screen in Remote Control Mode

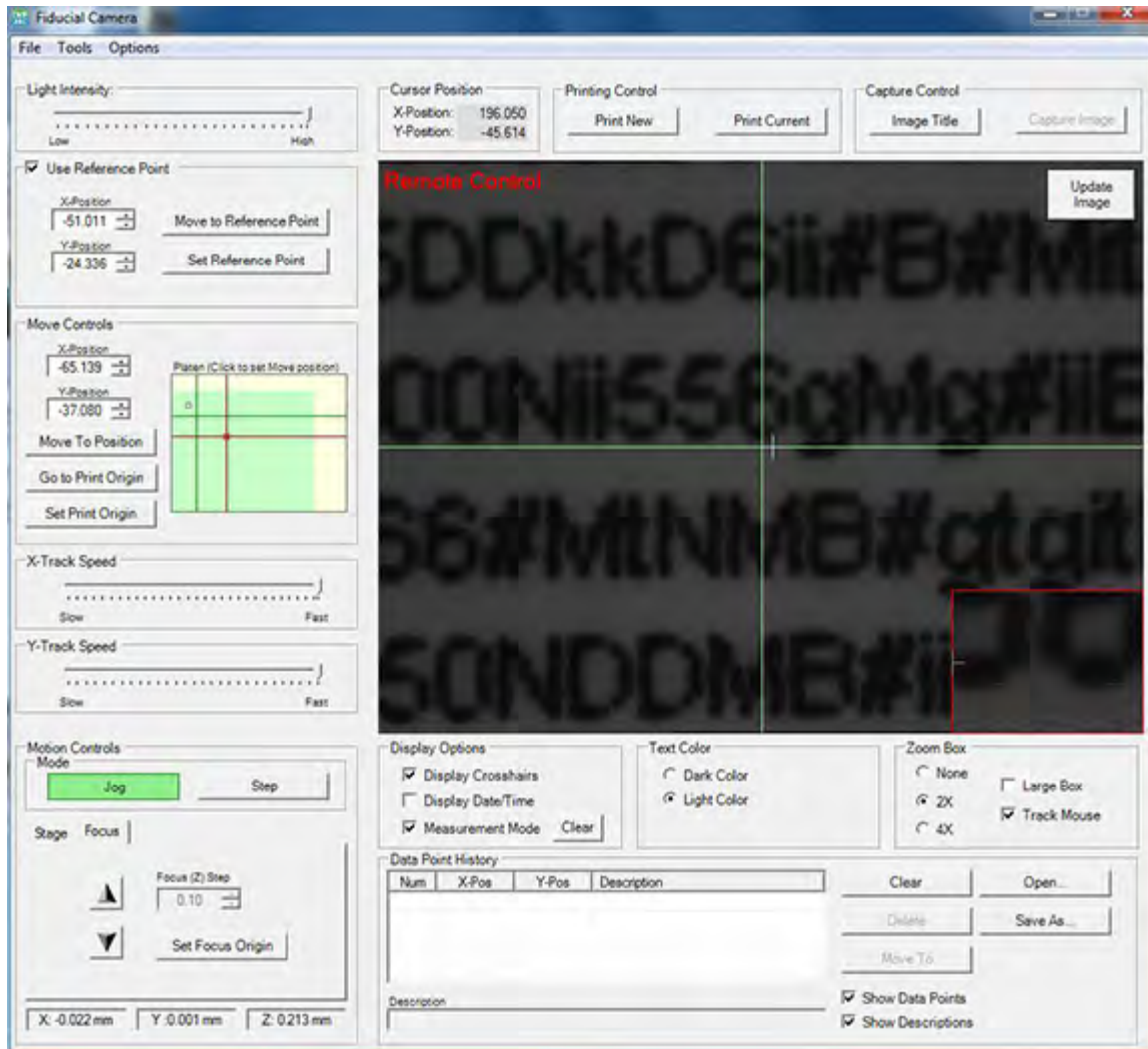

Figure 12 - 3 Fiducial Camera screen in Remote Control mode

Note: Your computer needs to have internet access for FUJIFILM Dimatix customer support to set up a remote control session. Running the session is independent from running the remote control option in the Drop Manager software. No special ports need to be opened for this to work. The regular Internet Explorer works fine.



Specifications

1.0 System Description

- Flat substrate, xyz stage, “ink jet” deposition system
- User-fillable, piezo-based ink jet print cartridges
- Built-in drop jetting observation system
- Variable jetting resolution and pattern creation PC-controlled with Graphical User Interface (GUI) application software
- Capable of jetting a wide range of fluids
- Heated vacuum platen
- Cartridge cleaning station
- Includes PC, monitor, and software



1.1 Mechanical System

- Printable area
 - Substrate size < 0.5 mm thickness: 210 mm x 315 mm (8.27 in x 12.4 in)
 - Substrate size 0.5 - 25 mm thickness: 210 mm x 260 mm (8.27 in x 10.2 in)
- Repeatability: $\pm 25 \mu\text{m}$ (± 0.001 in)
- Substrate holder
 - Vacuum platen
 - Temperature adjustable; ambient to 60 °C
- System footprint: 673 mm x 584 mm x 419 mm (26 in x 23 in x 16 in)
- Weight approximately 43 kg (95 lbs)
- Power 100-120 / 200-240 VAC 50/60Hz 375W maximum
 - Fuse @ 250 V 2A SLO-BLO 5 x 20 mm
 - Fuse @ 110 V 4A SLO-BLO 5 x 20 mm
- Operating range 15-40 °C at 5-80% RH non-condensing
- Altitude up to 2000 m
- Safety and EMC compliance
 - Safety: NRTL Certified to EN 61010-1, UL 61010-1, CSA 22.2 No. 61010-1
 - EMC: EN61326-1 Class A, FCC Part 15 Class A

2.0 Cartridge

- Type: Piezo-driven jetting device with integrated reservoir and heater
- Usable Ink Capacity: Up to 1.5 ml (user-fillable)
- Materials Compatibility: Many water-based, solvent, acidic or basic fluids
- Number of Nozzles: 16 nozzles, 254 μm spacing, single row

3.0 Control PC and Application Software

- Pre-loaded patterned templates
- Pattern preview
- Editors: Pattern, piezo-driven waveform, cleaning cycle, substrate setting
- Bitmap (1 bit) files accepted
- DXF, GDSII and OASIS file conversion to Bitmap using ACE Translator 3rd party software



4.0 Replaceable Items

- Print cartridge with one-time user-fillable reservoir
- Cleaning station nozzle blotting pad
- Drop watcher fluid absorbing pad

5.0 Options

- Fiducial camera for substrate alignment and measurement





Returning a DMP to Dimatix

When you have to return your DMP to Dimatix for repair, close adherence to our return procedure expedites the return. There are three tasks in processing a return:

1. Contact Dimatix Customer Service for return authorization.
2. Clean the DMP.
3. Pack up the DMP.

1.0 Return Authorization

A Returned Materials Authorization (RMA) is required prior to the return of your DMP. When contacting Dimatix Customer Service for an RMA, please have the following information available:

- Company name, contact name, contact phone, fax and/or e-mail information.
- Product being returned, with the Dimatix part number.
- The number of units being returned and their serial numbers.
- Description of the failure for each serial number. For example, “serial number 390054 has lost meniscus and vacuum.” The information provided about the failure is used to perform failure analysis and to determine appropriate repair steps. The more detailed the information provided, the better.
- Description of the fluids used (part number and supplier). An MSDS must be provided for any fluid or materials used in the printer when the product is returned to Dimatix. Information about the fluids also aids in determining repair steps and in failure analysis.

Forward this information to Dimatix Customer Service at:

Fax: #(603)448-3658 or e-mail: cs@dimatix.com.



A Customer Service Representative researches the return request with Technical Support, and either provides the RMA number or requests additional information. The RMA number must be recorded on the outside of the shipping container when the product is returned to Dimatix. MSDSs for any fluid or materials that were used in the printer must be included in the return shipment.

2.0 DMP-2800 Cleaning Procedures

The DMP to be returned should be thoroughly cleaned. This expedites the failure analysis. Autopsy returns are dependent upon the perceived problem. Check with Customer Service before readying the return as different rules on cleaning may apply.

CAUTION

Follow your company's personal protection gear policies when cleaning the DMP. At a minimum safety glasses, particle mask, lab gloves, and a protective coat should be worn.

1. Remove cartridge from printer.
2. Remove cleaning pad.
3. Remove drop watcher pad.
4. Turn off power.
5. Clean all available surfaces with 70% isopropanol using lint-free cloth. If there is any visible precipitated material or apparent film on printer parts, these areas must be thoroughly cleaned before returning. Use a more aggressive cleaning fluid if required.
6. Let the DMP dry completely before packing.

3.0 Packing up the DMP

It is imperative that you repack the DMP properly to avoid damage in transit. If you have retained the original shipping crate and materials, please use them when packaging for return. If the materials are not available, especially the wooden crate, make sure that the DMP is securely packaged with appropriate materials.



Online Tech Support

FUJIFILM Dimatix's Materials Deposition Online Tech Support provides all registered users with easy access to the following information:

- FAQs
- Order Supplies and Replacement Parts
- Ink Jet 101
- Web-based training
- Application Notes
- Popular Jetting Files
- Product Manuals
- DMP Printer Support
- MSDS

To register for a Tech Support account, click on the **Tech Support Sign In** link at the bottom of the FUJIFILM Dimatix home page (www.dimatix.com). On the Tech Support Welcome page, select **Create Account**. Complete the information and select Save.



**Symbols**

Alignment Procedures 84

Cleaning Function Definitions 122

Drop Spacing 46

Faults 133

Placement

50

Placement / Tiling 50

A

About this Manual ii

Cautions ii

Important iii

Notes iii

Warnings ii

Wheelie Bin Symbol iii

Alignment Procedures

Set the Reference Point 86

Alignment Procedures

Set Print Origin 85

Assembly 120

Attach Fluid Module to Jetting Module 120

Automove 96

B

Bitmap File

Substrate Tab 48

Drop Spacing 48

Layers 49

Leader Bar 48

Substrate Dimensions 48

Blot 28

Blotting 121

BMP File Printing 47

Bright Field 80

C

Calibrate Nozzle 63

Calibrate Nozzle View 73

Calibrate Thermal Scaling 95

Calibrate Theta 87, 93

Capture Control 83

Capture Image 67

Capture Movie. 67

Cartridge Alignment 130

Corrective action 132

cartridge angle scale 57

Cartridge Maintenance 121

Cartridge Mounting Angle 57

Cartridge Settings 61

Cartridge Tab 25

Cartridge Print Height 26

Jets to Use 25

Cleaning Cycles tab 26

Cartridge Settings 22

Cartridge Tab 25

Cartridge 117

Cleaning box 65

Cleaning Cycle

create 28

cleaning cycle

default 28

Cleaning Cycle Editor 27

Cleaning Cycle Editor screen 28

Cleaning Cycles 26

Cleaning Cycles Tab 26

Cleaning Pad 35

Replace 35

Cleaning Procedures 150

Configure 102

Configure Capture Quality 70

Configure Video Camera Input 103

**D**

Dark Field 80
 Delay 28
 Delay 100 72
 Dimatix Drop Manager 9
 Dimatix Materials Printer (DMP) 1
 Dimatix Model Fluid 105
 Display Options 83
 DMP 1
 air flow 6
 icon 9
 starting 9
 Draw feature 43
 Drop Manager 79
 Drop Offset 87, 130
 Drop Position Array 43
 Drop Refresh Rate 67
 Drop Spacing 43, 45
 Drop Velocity vs. Voltage 108
 Drop Viewing Speed 67
 Drop Volume Measurement 73
 Drop Watch Pad 63
 Drop Watcher 61
 Calibrate Nozzle View 63
 Capture Image/Movie button 70
 Cleaning Box 65
 Display Options 69
 Drop Watcher Pad 66
 Graticule Group 68
 Jetting Control box 72
 Jetting Nozzle Box 62
 Motion Control Box 65
 Movie Mode 67

Viewing Modes 66

Drop Watcher button 61
 drop watcher pad 66
 Drop Watcher software 70
 Drop Watcher 61

F

Failure Modes, Prevention and Recovery 123
 Fiducial Camera 80
 Bright Field 80
 bright field mode
 switch position 81
 Camera Field of View 80
 Dark Field 80
 dark field mode
 switch position 80
 Features 81
 Center X- Position 83
 Cursor X-Position 83
 Cursor Y- Position 83
 Data Point History 84
 Light Intensity 81
 Viewing and Capture Control
 Capture Image 83
 Configure 83
 Image Title 83
 X-Track Speed 82
 Y-, Y+, X-, X+ 83
 Y-Track Speed 82
 Light Intensity 80
 Fiducial Camera button 79
 Fiducial Camera Window
 File menu 103
 Exit 103
 Print Pattern 103
 Options 103
 Platen Vacuum 103
 Tools Menu 87
 Fiducial Camera 79



Fiducial Functions 79
Fluid Module Filling 118
 fill needle 119
 Fill Syringe 118
 Install filter onto syringe 118

Fluid Requirements

Degassing 105
Density 105
Filtration 105
Low Volatility 105
Surface Tension 105
Viscosity 105

Fluid Requirements 105

Focus Tab 82

G

Go to Print Origin 82

Graticule 73

I

Image Reference Point 81

Image Title 67

Image to Pattern Converter 47

Image/Movie Title 70

Important (Wichtig) vii

Increment Value 43

Initial Start-Up Operation 11

Install Cartridge 11

Introduction 1

J

Jetting Control Box 72

Jetting Frequency 72

Jetting Nozzle box 62

Jetting Waveform vs. Non-Jetting
 Waveform 32

M

Main menu

 Help menu 21

Main screen 19

 File menu 20

 Tools menu 20

Measure Cartridge Angle 99

Meniscus Control 121

Meniscus Vacuum 25

Misdirected Nozzles 125

 Corrective actions 127

Model Fluid 105

 jetting temperature 105

 surface tension 105

 viscosity 105

Motion Control box 66

Motion Controls 82

Move to Reference Point 81

Movie Mode 66

Movie Title 67

N

Non-Firing Nozzles

 Corrective actions 128

Non-Jetting Nozzles 127

Non-Jetting Wave Form 32

Non-Jetting Waveform 32

Non-Matched Velocities

 Corrective action 130

Non-Matched Velocities 129

O

Online Technical Support 151

P

Pattern Array 42

Pattern Block Array 42



- box 42
- Pattern Block Drop Position 43
- Pattern Editor 39
- Pattern Printing 37
 - Create Your Own Pattern 39
 - Select Pattern 38
- PC
 - cables 8
 - Start up 9
- PCI Video Capture 71
- Performance 107
 - Drop Velocity vs. Frequency 108
 - Drop Velocity vs. Voltage
 - with different Viscosities 108
 - Voltage vs. Drop Mass 109
- Platen 82
- Predefined Standard Patterns 39
- Preventative Maintenance 139
- Preview
 - Tiled 50
- Preview Drops 43
 - button 43
 - screen 43
 - window 43
- Preview Drops button 43
- Preview Spot Size 45
- Print
 - Use Reference Point 52
- Print Origin 81, 84
- Print Preview 54
 - Leader Bar 54
 - print origin 54
 - reference point 54
 - Tiled array 55
- Printer Information 21
- Printing Control 83
 - Print Current 83
 - Print New 83
- Purge 28
- Purging 121
- R**
- Reference Image 54
- Reference Information 140
- Reference Point 51, 81, 84
- Remote Control 22, 141
 - Update Image buttons 142
- Remote Control function 141
- Replacing Cleaning Pad 32
- Returned Materials Authorization 149
- Returning a DMP to Dimatix 149
- RMA 149
- S**
- Safety (Sicherheit) iv
- Safety Information iv
- Screen Descriptions 19
- Select Pattern 38
 - Pre-Defined Standard Patterns 39
- Set Drop Offset 87
- Set Drop Offset (Manual) 92
- Set Focus Origin 83
- Set Focus Stop 83
- Set Print Origin 82
- Set Reference Point 81
- Setting the Print Origin 85
- Setting the Reference Point 86
- Set-Up and Installation 5



- Show All Patterns 43
- Specifications
 - Cartridge 146
 - Control PC and Application Software 146
 - Options 147
 - Replaceable Items 147
 - System Description 145
 - Mechanical System 146
 - Specifications 145
- Spit 28
- Spitting 121
- Spot Size
 - Enable 46
 - Preview 45
- Stage Tab 82
- Start X Measurement 96
- Strobe Delay 72
- Substrate 40
 - Dimensions 40
 - Drop Spacing 41
 - Layers box 41
 - Count 41
 - Interlayer Delay 41
 - Preview Drops 41
 - Leader Bar 40
- Substrate thickness 26
- System Accessories 2
 - Cleaning pads 2
 - Drop watcher pads 2
 - Fill tips 2
 - Filters 2
 - Personal Computer 2
 - Starter Kit 2
 - Substrate location and positioning system 2
 - Syringes 2
- System Diagnostics 22
- System Diagnostics 135
- System Faults 133
- System Identification
 - Dimatix Materials Printer 3
 - Printer Carriage 4
- System Identification 3
- System Requirements 2
 - Environment 2
 - Operating 2
 - Humidity 2
 - Temperature 2
 - Power 2
- T**
- Text Color 83
- Things to remember 133
- Tickle Control 24, 32
- Tools menu
 - Cleaning Cycle Editor 27
- Tools Tab 73
- Trouble Shooting
 - Print Quality 125
- U**
- Unpacking
 - DMP 5
 - PC 7
- Unpacking 5
- Use Reference Point 81
- V**
- vernier scale 57
- View Cartridge settings 73
- Viewing Nozzle 63
- W**
- waveform



- single pulse 106
- Waveform Basics 30
- Waveform Basics 111
- Waveform Editor 30
 - Individual Segment Controls 31
 - Duration 31
 - Level 31
 - Slew Rate 31
 - Overall Waveform Controls 31
 - Duration Scaler 31
 - Maximum Jetting Frequency 31
 - Width 31
- Waveform editor 112
- Waveform Tab 23
- Windows Movie Maker 70
- X**
- X and Y position text fields 81
- X Width 43
- X-Position, Y-Position 82
- Y**
- Y height. 43
- Z**
- Zoom Box 83



Product status and specifications are subject to change. Please confirm latest data with a Dimatix representative.

Corporate Office: FUJIFILM Dimatix, Inc. 2230 Martin Avenue Santa Clara, CA 95050 USA Tel: 408-565-9150 Fax: 408-565-9151 Email: info@dimatix.com	New Hampshire Facility: FUJIFILM Dimatix, Inc. 109 Etna Road Lebanon, NH 03766 USA Tel: 603-443-5300 Fax: 603-448-9870 Email: info@dimatix.com	Japan Office: Advanced Marketing Business Div. FUJIFILM Corporation Midtown West, 7-3 Akaska 9-Chome Minato-ku, Tokyo 107-00002 Japan Tel: +81 3 6271 1091 Fax: +81 3 6271 1165 E-mail: front.ambd@fujifilm.co.jp	European Office: Tel: +44 7739 863 505 Fax: +44 870 167 4328 Email: euro@dimatix.com	Korean Office: Tel: +82 2 6242 6012 Fax: +82 2 6247 6012 Email: korea@dimatix.com China Office: Email: china@dimatix.com
---	--	--	--	---



www.dimatix.com